



UNDERCABINET LIGHTING

PRO-SERIES LED
3000K LEDs, DIMMABLE

**UPLD09, UPLD14,
UPLD22 and UPLD30**



Project: _____

Fixture Type: _____

Location: _____

Contact/Phone: _____

PRODUCT DESCRIPTION

The Pro-Series LED modular series with integral electronic driver operates 3000K LEDs for maintenance free 50,000 hour life using 1/6 the energy and virtually no heat when compared to halogen & xenon. Pro-Series LED fixtures are optimized for fast permanent installation, mounting either flush to the rear backsplash or to the front lip of cabinetry to suit project conditions and homeowner preference. Pro-Series LED fixtures are environmentally friendly and contain no harmful mercury. 5-year limited warranty.

PRODUCT SPECIFICATIONS

LEDs Utilizes warm-white 3000K LEDs tightly binned to within a 2-step MacAdam ellipse for superb color consistency • Light output equivalent to Pro-Series Halogen & Pro-Series Xenon fixtures • Provides 50,000 hour service life • 80 CRI minimum.

Driver Integral electronic 120-volt constant current driver is accessible without having to remove fixture • Dimmable with most incandescent, magnetic low voltage or electronic low voltage wall box dimmers • For a list of compatible dimmers, refer to next page.

Housing Slim 1" profile • Modular plug-together design • Extruded Aluminum • Designer white, black, brushed bronze, or brushed silver.

Diffuser Clear prismatic tempered glass lens for maximum light transmission • Reverse-angled to minimize perceived brightness.

Switch Available with or without convenient integral On/Off rocker switch.

Optional Integral Occupancy Sensor 22" and 30" are available with Passive Infrared (PIR) Occupancy Sensor. The PIR sensor has a field adjustable time delay that can be set from 30 sec. to 30 min. All additional luminaires connected to the luminaire with occupancy sensor will be controlled by the single sensor.

Labels cULus listed for damp locations.

INSTALLATION

UPLD Series fixtures offer several convenient methods for installation and can be installed as direct wire or portable luminaires. Fixtures may be mounted flush to the backsplash or up against the front lip of the cabinetry using captive mounting screws.

Direct Wire The UPLD14, UPLD22, and UPLD30 are optimized with a center rear wiring access compartment and push-in electrical connectors for quick electrical connection using non-metallic or armored cable • The UPLD14, UPLD22, and UPLD30 also feature multiple off-center knockouts and are supplied with die cast fittings for 3/8" flexible metal conduit • Optional direct-wire modules sold separately supplied with a jumper cord to bring power to the fixture, is also available to facilitate code compliant installation of fixture at the front end of cabinetry • Please note that if direct wiring is required for the UPLD09, a direct wire module must be utilized.

Portable To install the UPLD14, UPLD22, or UPLD30 as a portable fixture, use the optional 3-wire grounded cord & plug (U6CP sold separately) or specify 6CP option. Note: UPLD09 cannot be wired with U6CP.

Electrically Connecting Multiple Fixtures Connect multiple fixtures for up to 5 amps maximum combined operating current • Fixtures may be electrically joined together using either the straight joiner connector supplied with each fixture or the optional JC3 jumper cords • See accessories table for lengths and colors. See engineering data table for input current draw of each fixture size.

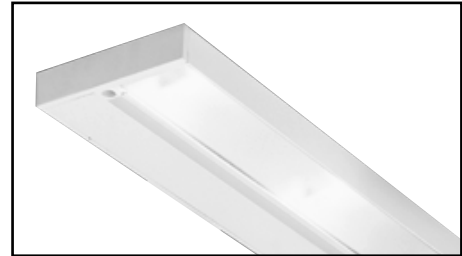

DIMENSIONS

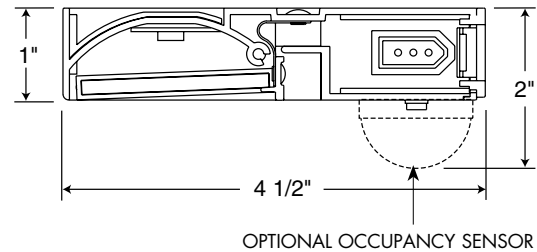

ENGINEERING DATA

	UPLD09	UPLD14	UPLD22	UPLD30
Total input power (watts)	3.2	5.6	8.1	10.7
Total Operating AMPS	.03	.05	.07	.10
Lumens	150	299	454	601
Lumens/watt	47	53	56	56

PRO-SERIES LED 5 MINUTE DIRECT-WIRE INSTALLATION FOR UPLD14, UPLD22 & UPLD30 ONLY

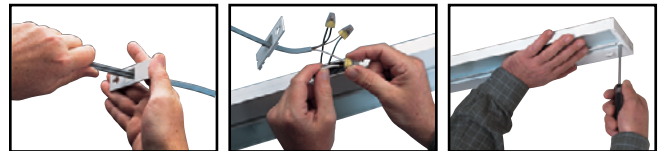

Step 1 Attach supply wires to rear access cover.

Step 2 Connect supply wires to fixture leads using push-in connectors.

Step 3 Mount fixture to cabinet bottom using captive mounting screws.

ORDERING INFORMATION (Type fixture options in the blank form fields below)

Example: UPLD09 30K 80CRI WH 6CP NS

Series	CCT	Minimum CRI	Finish	Portable Wiring	Control Option
UPLD09 Pro-Series LED Undercabinet, 9"	30K 3000K	80CRI 80 CRI	BL Black	6CP ^{1,2} Portable w/ 6' Cord & Plug	Blank Rocker Switch
UPLD14 Pro-Series LED Undercabinet, 14"			BZ Brushed Bronze		NS No Switch
UPLD22 Pro-Series LED Undercabinet, 22"			SL Brushed Silver		OC ³ Occupancy Sensor with Switch
UPLD30 Pro-Series LED Undercabinet, 30"			WH White		OCNS ³ Occupancy Sensor w/o Switch

¹Portable wiring cannot be used with occupancy sensors. ²Portable wiring not available on UPLD09. ³Occupancy Sensor only available for UPLD22 and UPLD30.



UNDERCABINET LIGHTING

PRO-SERIES LED
3000K LEDs, DIMMABLE

**UPLED09, UPLED14,
UPLED22 and UPLED30**

ACCESSORIES

Catalog Numbers	Description
JC3 8IN BL	Juno Undercabinet Jumper Cord, 8", Black
JC3 8IN WH	Juno Undercabinet Jumper Cord, 8", White
JC3 17IN BL	Juno Undercabinet Jumper Cord, 17", Black
JC3 17IN WH	Juno Undercabinet Jumper Cord, 17", White
JC3 26IN BL	Juno Undercabinet Jumper Cord, 26", Black
JC3 26IN WH	Juno Undercabinet Jumper Cord, 26", White
UCONN	3/8" Miniature Die Cast electrical Connector
U6CP BL	Juno Undercabinet 6" Cord & Plug, Black
U6CP WH	Juno Undercabinet 6" Cord & Plug, White
UDWMOB BL	Juno Undercabinet Direct Wire Occupancy Sensor Module, Black, No Switch
UDWMOB BL RS	Juno Undercabinet Direct Wire Occupancy Sensor Module, Black, Rocker Switch
UDWMOB WH	Juno Undercabinet Direct Wire Occupancy Sensor Module, White, No Switch
UDWMOB WH RS	Juno Undercabinet Direct Wire Occupancy Sensor Module, White, Rocker Switch
UDWM BL	Juno Undercabinet Direct Wire Module, Black
UDWM WH	Juno Undercabinet Direct Wire Module, White



UDWMOB

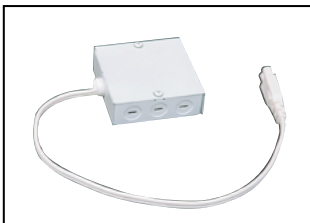
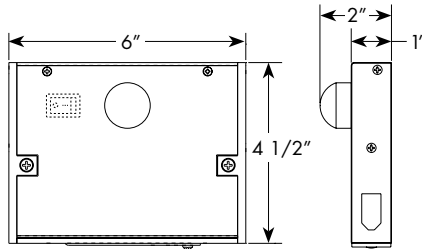

UDWM

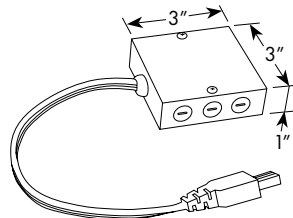

UNDERCABINET LIGHTING

PRO-SERIES LED
3000K LEDs, DIMMABLE

**UPLED09, UPLED14,
UPLED22 and UPLED30**

LIGHTING APPLICATION DATA

FOOTCANDLES ON HORIZONTAL WORK SURFACE

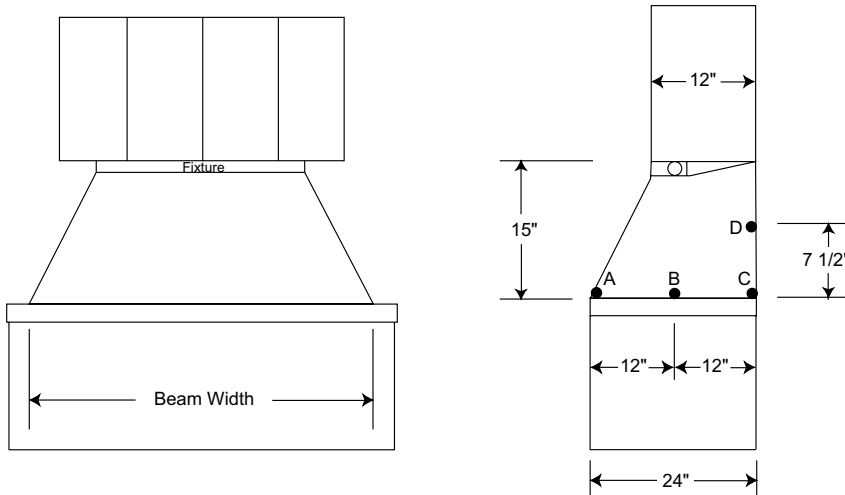

Catalog Numbers	Beam Width*	Footcandles			
		A	B	C	D
UPLED09	20	15.7	45.1	23.3	20
UPLED14	23	31.4	86	44.8	36.2
UPLED22	28	40.9	108	61.2	48.9
UPLED30	33	50.1	130	76.1	55.9

* Beam width defined as 50% of maximum footcandles
Fixture mounted at front lip of cabinet
Rear wall reflectance 50%
Counter Surface Reflectance 20%

DIMMER COMPATIBILITY

Dimmable with most standard incandescent, magnetic low voltage or electronic low voltage dimmers. Dimming range depends on dimmer model. Compatible dimmers include but are not limited to the following Juno qualified dimmers listed below. Note: Due to the low wattage of UPLED09, it is recommended to combine this luminaire on a dimmer with at least one additional luminaire for best dimming performance.

INCANDESCENT AND MAGNETIC LOW VOLTAGE DIMMERS

Lutron® Model Numbers:

Glyder® GLV Series*
Diva® DV/DVLV Series
Ariadni® AY Series
Skylark® S Series
Ceana® CNLV Series*
Nova T☆® NTLV Series*

Leviton® Model Numbers:

Trimatron #6681

ELECTRONIC LOW VOLTAGE DIMMERS

Lutron® Model Numbers:

Nova T☆® NTELV Series
Skylark® SELV Series*
Diva® DVELV Series
Faedra® FAELV Series*
Spacer System® SPSELV Series*

Leviton® Model Numbers:

Illumatech® IPE04 Series

(Dimmer has manual trim adjustment for low end of dimming range to achieve 5% dimming)

Whole House Integrated Control Systems:

Schneider Electric C-Bus SLC5504TD4A*
Lutron® Homeworks® QS HQRD-6NA*
Lutron® Radio RA2® RRD-6NA*
Lutron® Radio RA2® RRD-10ND*
Sensor Switch® nSP5PCD-ELV*
Sensor Switch® nSP5PCD-2W*

*Juno recommended dimmers