

OVERVIEW

Easy!™ is a DMX512 controller featuring an LCD touchscreen. Easy!'s powerfully simple interface enables intuitive control of an entire universe (512 channels) of color changing luminaires. Preprogrammed shows with static and color changing effects simplify initial setup and provide a great starting point for customization. Easy!™ provides design, edit, store and recall functions for a maximum of 12 shows and features quick adjust intensity and speed sliders. Easy!™ controls LED luminaires that are DMX512-A compliant, including those with RDM functionality.

Easy!™ Solo Is a standalone entry-level controller enabling show creation and playback directly at the LCD touchscreen.

Easy!™ Touch features an astronomic time clock for automating shows and expands the controller's features by accepting inputs from remote button stations, and button station contact closure inputs.

Easy!™ Pro is further enhanced by using Easy! Studio™ computer software to create multi-zone shows, and Easy! Pro features a 20 hour DMX512 capture from a theatrical console.

FEATURES

- Modern aesthetic that installs in a single gang box
- Full color LCD touchscreen
- User defined programs and naming
- Customizable settings for screen brightness, access control passcodes, and screensaver image
- Master intensity and playback speed adjustment.
- Power failure memory
- Integrated help screens

Warranty

Two-year limited warranty. Complete warranty terms located at: www.acuitybrands.com/CustomerResources/Terms_and_conditions.aspx

Note: Actual performance may differ as a result of end-user environment and application.

Specifications subject to change without notice.



Fresco™

EZ Solo
EZ Touch
EZ Pro
 DMX 512 Show Controller



ORDERING INFORMATION

EZ		Example: EZSOLO MVOLT BK		
Series		Supply Voltage		Finish
EZSOLO	Entry level, stand alone DMX controller	MVOLT	120-277 VAC, 50/60 Hz	WH White
EZTOUCH	Mid level, functions with EZ RB button stations, features timeclock	347	347VAC	BK Black
EZPRO	Pro Level, functions with EZ RB and EZ RB PRO RTS stations, features timeclock and configuration software			

EasyL™ Power Supply

Each EasyL™ controller is provided with a 24VDC power supply (FCS PS10 or EZPS 347). The power supply is remotely installed on a standard electrical enclosure. When ordering an EasyL™, the voltage selected determines which power supply is provided with the controller.

SPECIFICATIONS

FUNCTIONAL

EasyL™ Controller (EasyL™ Solo | Touch | Pro)

- DMX Controller
- 3.5" Color LCD touchscreen
- Resistive touchscreen technology works well with gloves and prosthetics
- Internally stores 12 shows
- 64,000 available colors on LCD
- Adjustable backlight control
- Adjustable timeout period
- Screen lockout passcode
- Programming lockout passcode
- Colors: Black, White
- Supports up to 3 remote stations (Touch & Pro only)
- Show naming on screen

ELECTRICAL

- Input Voltage: 24VDC (Class 2)
- Input Power: 1.0W nominal
- Current: 40mA max

ENVIRONMENTAL

- Operating Temp: 14 to 105F (-10 to 40C)
- Storage Temp: -14 to 160F (-26 to 71C)
- Relative Humidity: 90% non-condensing

MECHANICAL

- Mounts to single gang backbox

DIMENSIONS

- All dimensions are inches (millimeters)
- Size: 5.06" H X 3.5" W X 0.69" D
- (128.5 x 88.9 x 17.5)
- Weight: 6 oz (0.17Kg)

OTHER

- Compatible with DMX512-A ANSI E1.11-2008
- Compatible with DMX512 RDM ANSI E1.20-2006
- DMX Channels: 512
- Standalone Memory: 20 hours of shows (Pro only)
- Made in the USA
- 2 Year Limited Warranty

EasyL™ Power Supply

- Class 2 power supply
- Installs on standard electrical enclosures

ELECTRICAL

- Input - FCS PS10: 120-277VAC
- Input - EZPS 347: 347VAC
- Power Draw: 2.0W nominal
- Output: 24VDC Class 2

ENVIRONMENTAL

- Operating Temp: 32 to 105°F (0 to 40°C)
- Storage Temp: -14 to 160°F (-26 to 71°C)
- Relative Humidity: 90% non-condensing

MECHANICAL

- Mounts in a 1/2" knockout in a standard enclosure, remote from the EasyL station.

DIMENSIONS

- All dimensions are inches (millimeters)
- Size: 3.5" H X 2.56" W X 1.81" D (76.2 x 57.5 x 47.7)
- Weight: 6 oz (0.17Kg)

STANDARDS (FCS PS10/EZPS 347)

- UL/CUL
- Plenum Rated

WIRING DIAGRAMS

Always read product installation instructions prior to installation

Easy!™ Solo MVOLT

The DMX 512 Daisy Chained Network Requires:

- Network termination at the first and last device.
- 3 conductor cable containing a twisted and shielded pair for data
 - Common
 - Data+
 - Data-
 - Shield (Ground at the Easy! backbox)
- Easy! has a built in network termination switch which is factory set to "ON".

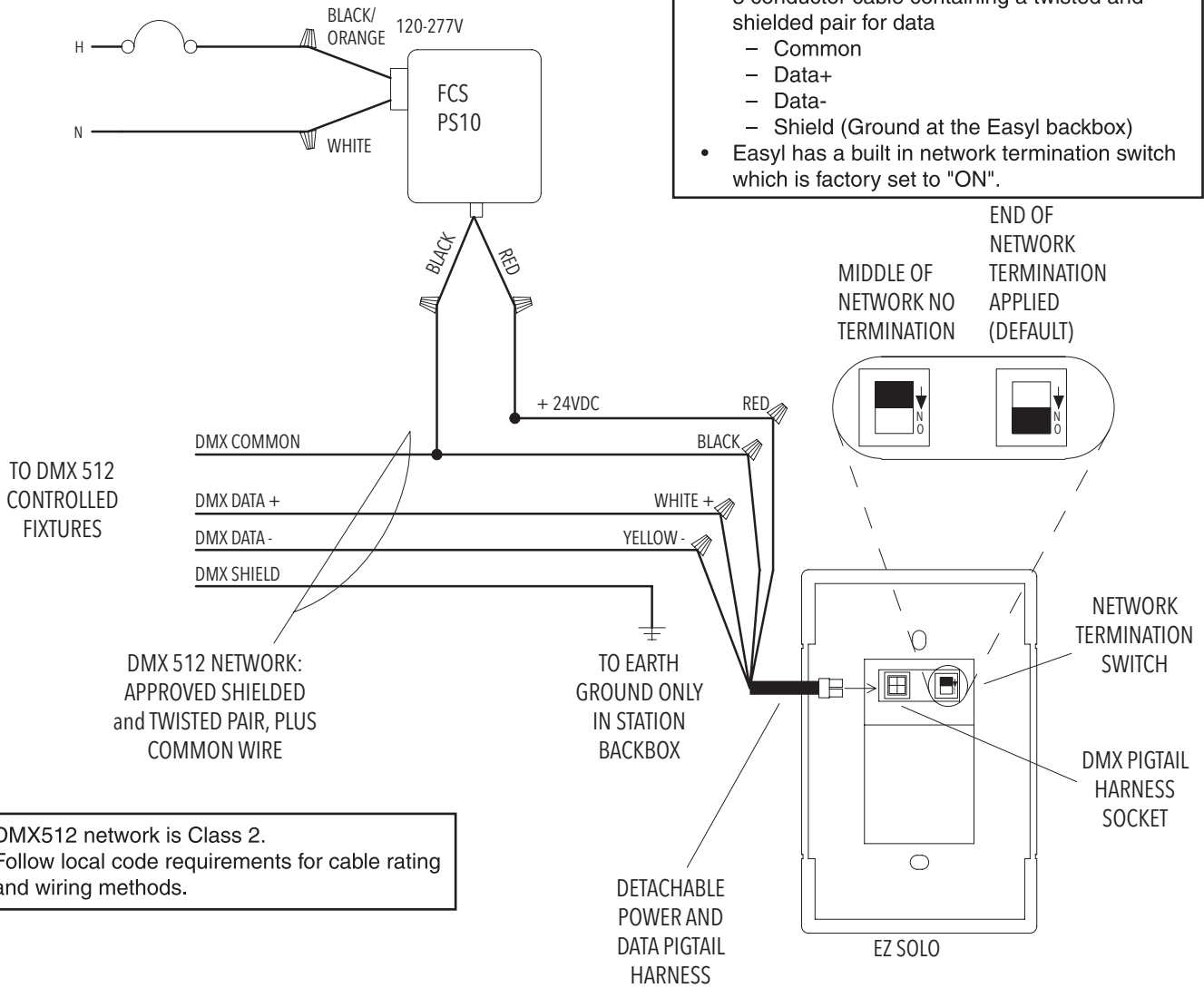

Easy!™ Solo Typical Network

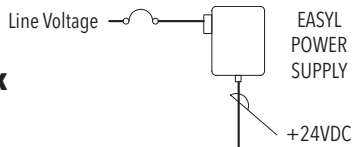

NOTES:

- 1 If a DMX device contains a termination switch it should be "OFF", unless it is at either end of the DMX network.
- 2 If a DMX device is at either end of the DMX network and does not have a termination switch, then install a 120 ohm 2W resistor across data + and -, or add a DMX terminator to the end device.

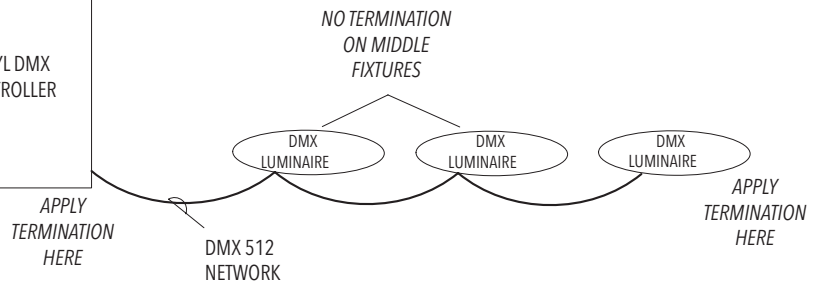

Easy Touch | Pro MVOLT

Without Auxillary Button Stations or EasyL RTS

The DMX 512 Daisy Chained network requires:

- Network termination at the first and last device.
- 3 conductor cable containing a twisted and shielded pair for data
 - Common
 - Data+
 - Data-
 - Shield (Ground at the EasyL backbox)
- EasyL has a built in network termination switch which is factory set to "ON".

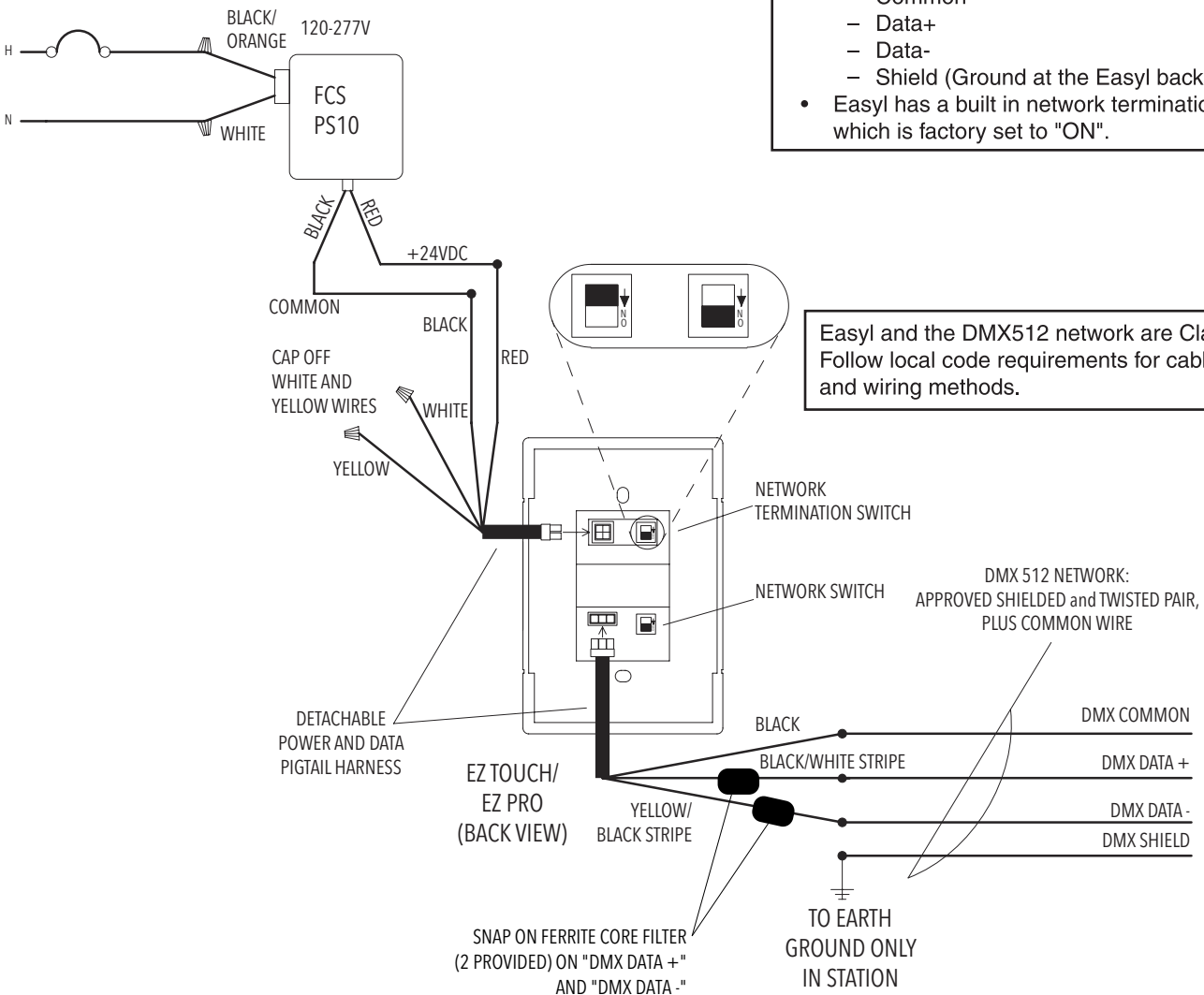

EasyL Touch/Pro Typical Network

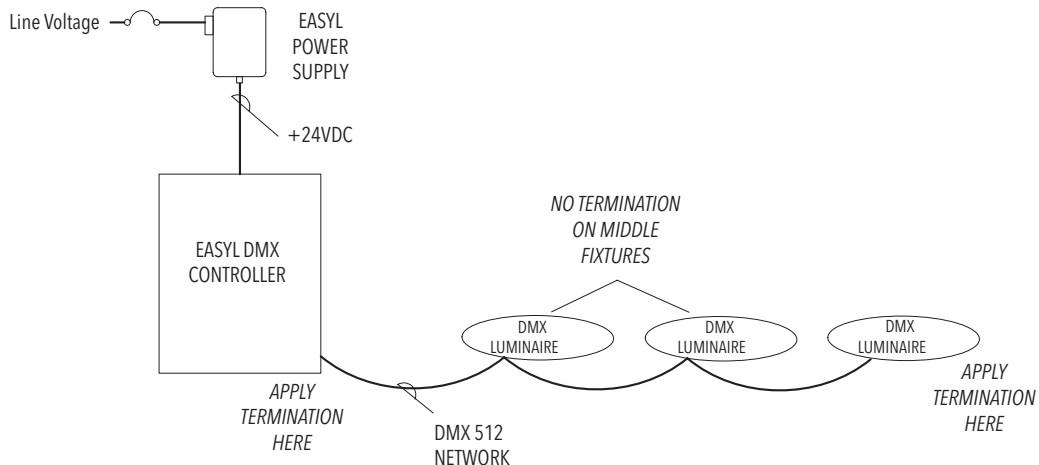

Easy Touch | Pro MVOLT

With Button Stations

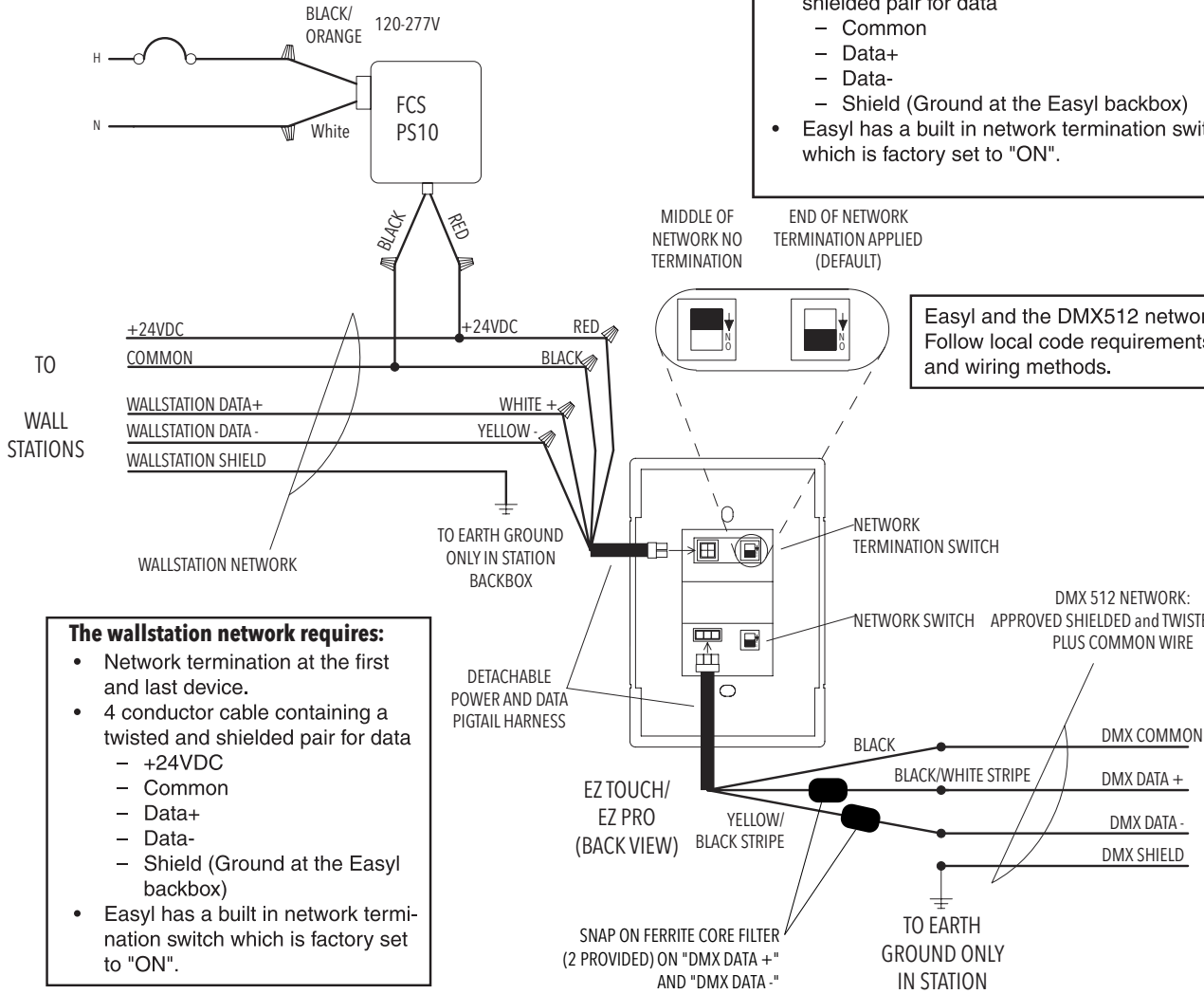

The DMX 512 Daisy Chained network requires:

- Network termination at the first and last device.
- 3 conductor cable containing a twisted and shielded pair for data
 - Common
 - Data+
 - Data-
 - Shield (Ground at the Easytl backbox)
- Easytl has a built in network termination switch which is factory set to "ON".

Easytl and the DMX512 network are Class 2. Follow local code requirements for cable rating and wiring methods.

The wallstation network requires:

- Network termination at the first and last device.
- 4 conductor cable containing a twisted and shielded pair for data
 - +24VDC
 - Common
 - Data+
 - Data-
 - Shield (Ground at the Easytl backbox)
- Easytl has a built in network termination switch which is factory set to "ON".

Easytl Touch/Pro with Remote Stations Typical Network

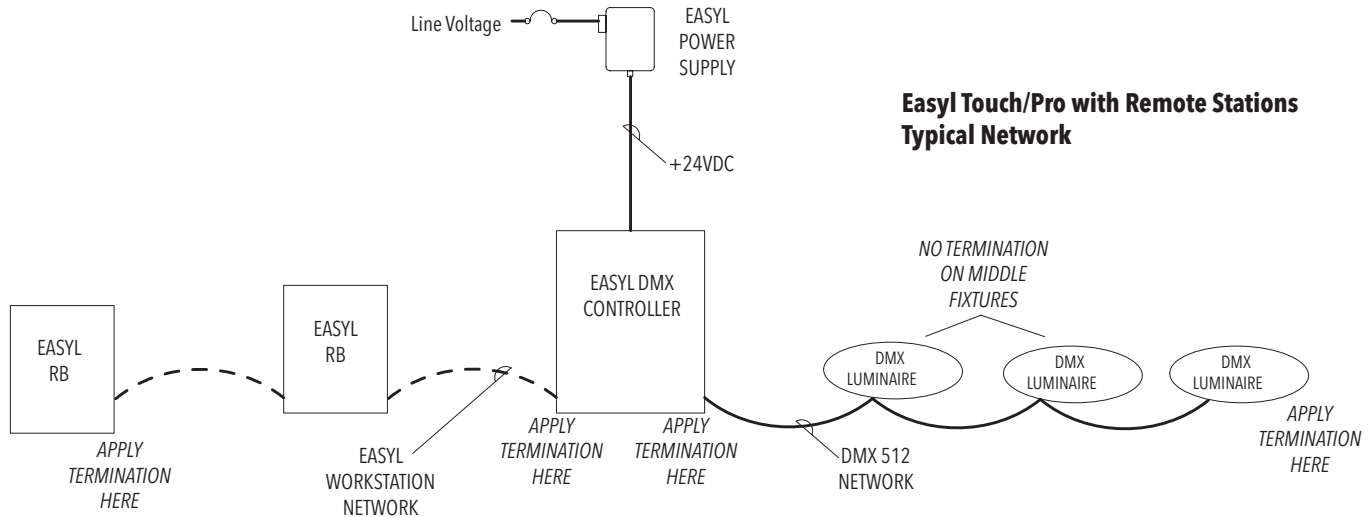

EASYL FEATURE COMPARISON

Easy! Features	SOLO	TOUCH	PRO
Preprogrammed shows, rainbow feature, chase feature	Yes	Yes	Yes
On-screen manual color select with favorites store & recall	Yes	Yes	Yes
On-screen master intensity slider	Yes	Yes	Yes
On-screen master speed control slider	Yes	Yes	Yes
Compatible with DMX512 and RDM fixtures	Yes	Yes	Yes
Configure on-screen logo and screen saver	Yes	Yes	Yes
Edit all shows through LCD Interface	Yes	Yes	
Basic show editing through LCD (complex features accessible in software through internal USB port)			Yes
Standalone only, no remote stations	Yes		
Operates with EZ RB 1-9 Button wallstations		Yes	Yes
Astronomic time clock (play show, set color, turn off, last command takes precedence)		Yes	
Astronomic time clock with advanced control (play show, set color, remote touchscreen or wallstation disable)			Yes
Computer based software for multi area show creation (Easy!™ Studio)			Yes
Allow temporary "override" and returns to previously playing show			Yes