



Nlight Air Operation, Programming and Maintenance Manual

Project Name:
Project Location:
Acuity Agency:
Order #:
PO #:
Project ID:
Date:

Controls Tech Support:

1-800-535-2465 - option 1: nLight; option 2: SSI; option 3: Fresco; option 4: Synergy; option 5: LC&D/Bluebox; option 6 ROAM

To preschedule a call with tech support (providing a 4 hour business lead time) go to the following link:

<http://www.acuitybrands.com/resources/schedule-support-request>

Additional Technical Literature:

<https://www.acuitybrands.com/products/controls/nlightair>

Table of Contents

<u>Nlight Air Quick Start Guide</u>	3
<u>Eclipse User Reference Guide</u>	6
<u>SensorView Installation Guide</u>	140
<u>SensorView User Manual</u>	141
<u>CLAIRITY Pro Mobile App User Guide</u>	264

nLight® AIR Quick Start Guide

The 5 C's of nLight AIR Installation and Startup



Definitions

- Zone: One or more devices that have common programming. A device can be in multiple Zones.
- Group: A set of devices and one or more Zones that are intended to function together. Typically used for room-level programming.
- Site: A set of groups, zones, and devices that reside in a certain building or address.

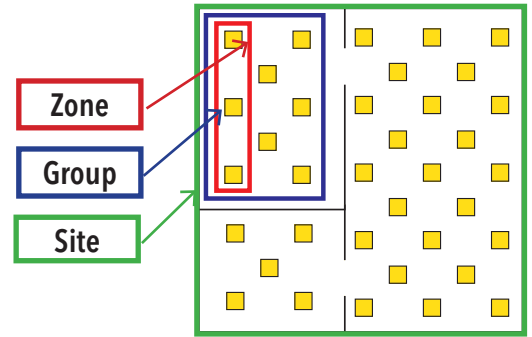

Construction

Install and energize the nLight AIR devices (fixtures and wall switches). At least one group of nLight AIR devices must be installed prior to starting the Configure step.

Create

For new users, use the Clarity™ mobile app to create a User ID (email address) and password. Then, create your Site in Clarity by entering the required information about the Site. This may be completed before installation of the devices. It is recommended that you share the Site with others so they may assist with startup, on-going maintenance, or future re-purposing (see Collaborate on next page).

An internet connection is required to log in and create a Site within Clarity.

Create an account:

Create a login by touching Sign up

Insert email address & touch Send verification code

Check email for verification code

Paste code from email & touch Verify code

Complete entering sign-up information

Create a Site:

Touch the + to create a Site

Enter Site details & touch Create

Configure

Use the Clarity mobile app to identify a group of devices and place them on the grid.

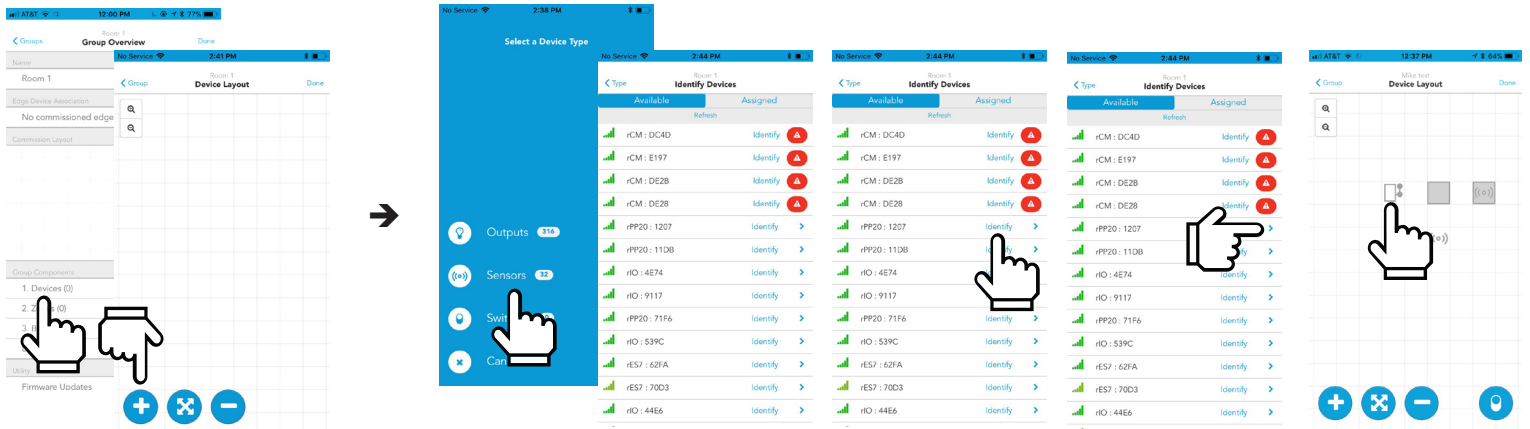

Select Devices, then touch the +

First select a Device Type (we selected **Sensors**). Once the devices populate, touch **Identify** and the device will blink to identify itself.

Next, touch the arrow > and place the device on the grid that appears.

*Note: To identify a switch, first press any button on the physical switch(s) to wake. Then touch device type **Switches**, and the list of awake switches will populate.*

Customize

Use the Clarity mobile app to create zones of control and define behaviors for each. Each device can be in one or more zones

Create a Zone:

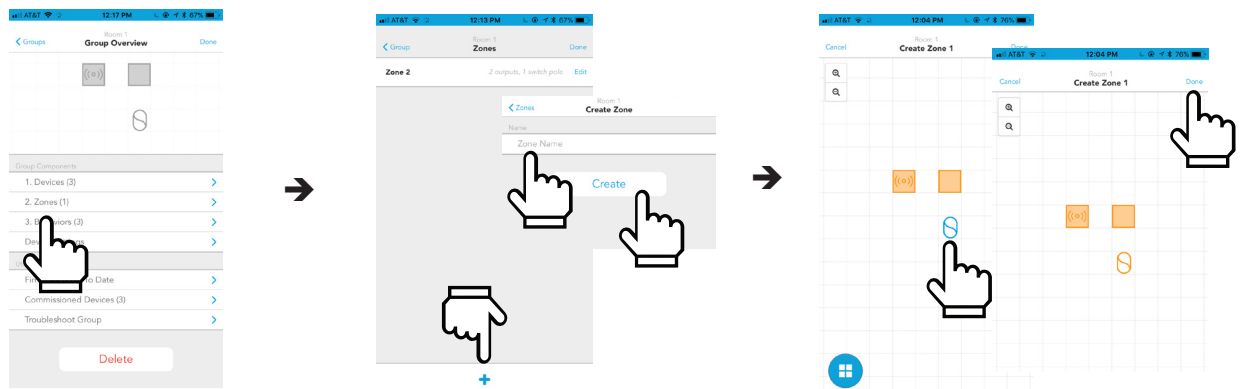

Select **Zones**

Touch the +
Enter Zone name then touch **Create**

Touch devices to add them to the Zone, then touch **Done**

Program Zone Behaviors:

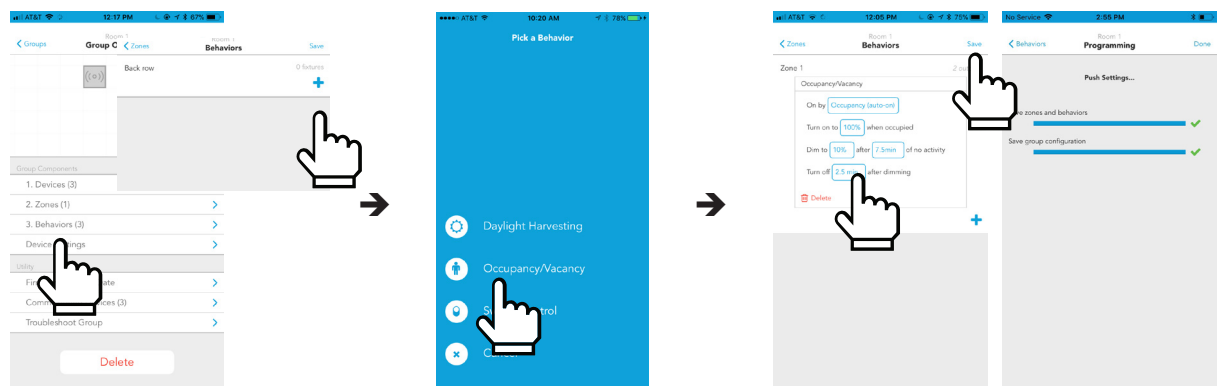

Select **Behaviors** then touch the +

Select a Behavior

Define Behaviors for each Zone & Touch **Save**

Collaborate

Using the login and password you created for the Clairity mobile app, log into air.acuitynext.com to share your site with your customer or colleagues. You may share the site with the end user for their ongoing maintenance or with colleagues so they may assist with support. Choose site share in the header, select the site to share, and add users to receive access.

Step 1. Log in to air.acuitynext.com using the email address and password you created to login to the Clairity Mobile App

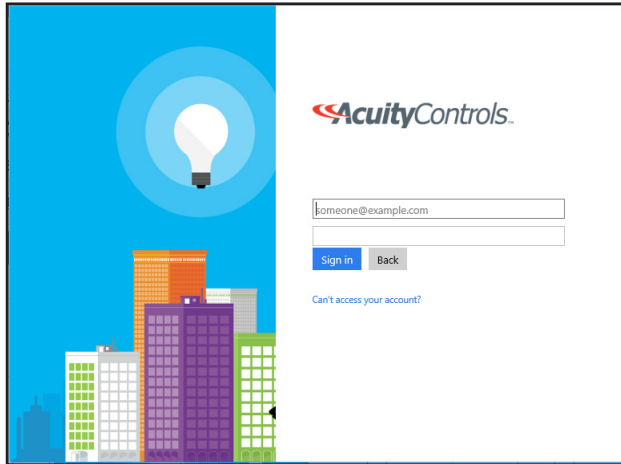
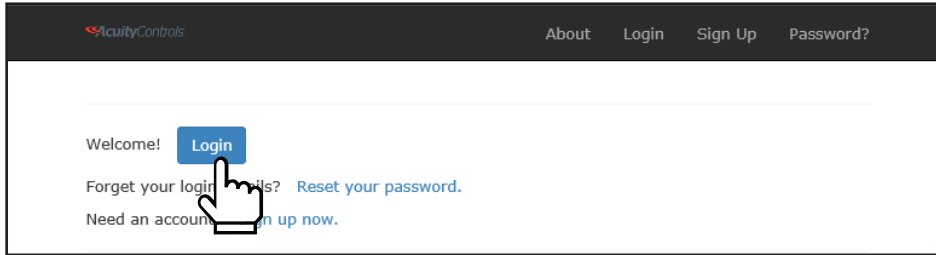

Step 2. Click "Site Share"

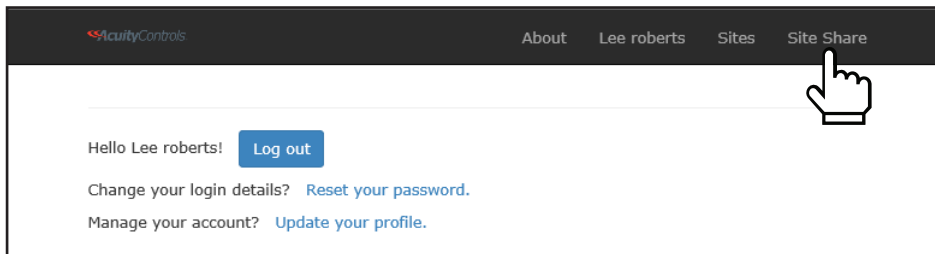

Step 3. Select the site to share by moving through the list or, if you know the site name, using the **Search** function

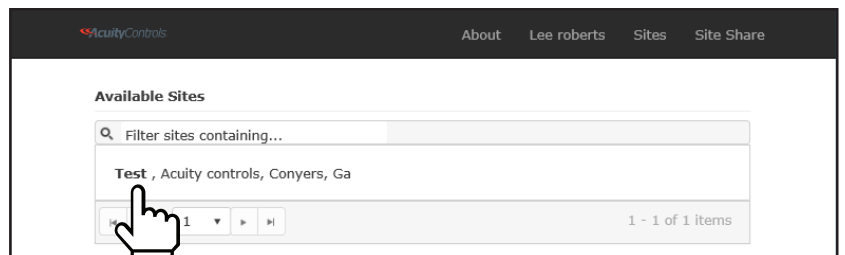

Step 4. To share a site with a User, enter the User's email address into the Search bar.

NOTE: Sharing sites requires that all Users already have created a Clairity account.

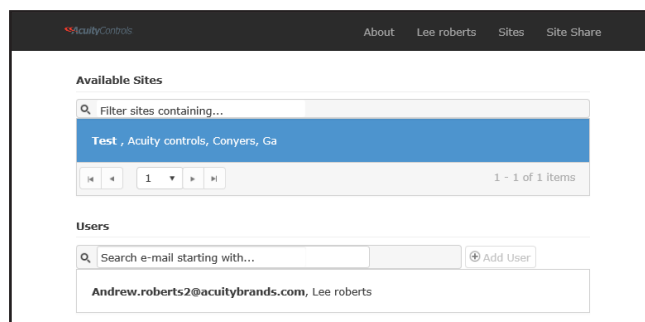

ECLYPSE®

User Reference Guide



Table of Contents

CHAPTER 1	5
INTRODUCTION	5
Overview.....	6
About This User Guide	7
Acronyms and Abbreviations Used in this Document	9
CHAPTER 2	11
INTERNET PROTOCOL SUITE FUNDAMENTALS.....	11
About the Internet Network.....	12
Internet Protocol Suite Overview	13
CHAPTER 3	14
IPV4 COMMUNICATION FUNDAMENTALS.....	14
DHCP versus Manual Network Settings	15
About Routers, Switches, and Hubs	15
CHAPTER 4	18
nLight ECLYPSE CONTROLLER IP NETWORK PROTOCOLS AND PORT NUMBERS	18
About Port Numbers.....	19
nLight ECLYPSE IP Network Port Numbers and Protocols	20
nLight ECLYPSE Services that Require Internet Connectivity	22
CHAPTER 5	23
CONNECTING IP DEVICES TO AN IP NET	23
WORK.....	23
Connecting the IP Network.....	24
Wireless Network Connection	28
Wireless Network Commissioning Architectures	54
CHAPTER 6	59
FIRST TIME CONNECTION TO AN nLight ECLYPSE CONTROLLER	59
Connecting to the Controller	60
Wi-Fi Network Connection	64
Configuring the Controller.....	65
Connecting to the Controller’s Configuration Web.....	69

Interface	69
CHAPTER 7	70
nLight ECLYPSE WEB INTERFACE	70
Overview	71
NetworkSettings	75
BACnet Settings	82
User Management	89
System Settings.....	95
CHAPTER 8	95
CONFIGURING THE nLight ECLYPSE WI-FI.....	95
ADAPTER WIRELESS NETWORKS.....	95
Setting up a Wi-Fi Client Wireless Network.....	96
Setting up a Wi-Fi Access Point Wireless Network	97
Setting up a Wi-Fi Hotspot Wireless Network	99
CHAPTER 9	101
SECURING AN nLight ECLYPSE CONTROLLER.....	101
Introduction.....	102
Passwords	103
Account Management and Permissions	104
HTTPS Certificates.....	106
Additional Measures.....	107
External Factors	108
CHAPTER 10.....	109
BACNET MS/TP COMMUNICATION DATA.....	109
BUS FUNDAMENTALS	109
BACnet MS/TP Data Transmission Essentials.....	110
Maximum Number of BACnet MS/TP Devices on a.....	112
Data Bus Segment and Baud Rate	112
Data Bus Physical Specifications and Cable Require- ments.....	115
Data Bus Topology and EOL Terminations.....	117
Data Bus Shield Grounding Requirements	121
Using Repeaters to Extend the Data Bus	125
Device Addressing.....	128
Power Supply Requirements for 24VAC-Powered	135

Controllers	135
CHAPTER 11	138
Resetting or Rebooting the Controller	138
Resetting or Rebooting the Controller	139
CHAPTER 16	140
NECY CONTROLLER TROUBLESHOOTING	140
CHAPTER 18	145
WI-FI NETWORK TROUBLESHOOTING GUIDE	145

CHAPTER 1

INTRODUCTION

This section provides an overview of the user guide.

Topics

[Overview](#)

[About This User Guide](#)

[Acronyms and Abbreviations Used in this Document](#)

Overview

This document describes best practices, specifications, wiring rules, and application information to implement robust and reliable communications networks.

About the NECY Series Controller

The NECY Series Controller is a modular and scalable platform that is used to control a wide range of HVAC applications. It uses IP protocol to communicate on wired Ethernet networks and Wi-Fi to communication on wireless networks.

This user guide also explains how to connect to the nLIGHT ECLYPSE controller's configuration interfaces.

About the IP Protocol Suite

Distech Controls' nLight ECLYPSE Series controllers use a widely used IP protocol to communicate with each other and with other applications for control and supervision. What is commonly referred to as IP is actually a multi-layered protocol suite that reliably transmits data over the public Internet and privately firewalled-off intranets. As integral part of our interconnected world, this protocol is used by applications such as the World Wide Web, email, File Transfer Protocol (FTP), datashares, and so on.

nLight ECLYPSE Series controllers are able to work across geographic boundaries as a unified entity for control and administration purposes.

About BACnet[®]

The BACnet[®] ANSI/ASHRAE[™] Standard 135-2008 specifies a number of Local Area Network (LAN) transport types. Distech Controls' controllers support both BACnet/IP and BACnet Master-Slave/Token-Passing (MS/TP) communications data bus (based on the EIA-485 medium) as a local network for inter-networking of supervisory controllers and field controllers.

About This User Guide

Purpose of the User Guide



This user guide does not provide and does not intend to provide instructions for safe wiring practices. It is the user's responsibility to adhere to the safety codes, safe wiring guidelines, and safe working practices to conform to the rules and regulations in effect in the job site jurisdiction. This user guide does not intend to provide all the information and knowledge of an experienced HVAC technician or engineer.

This user guide shows you how to integrate nLight ECLYPSE controllers into your IP network environment while enforcing standard network security practices.

Referenced Documentation

The follow documentation is referenced in this document.

- Controller Hardware Installation Guides: These documents are available at www.acuitybrands.com

nLIGHT ECLYPSE Introduction

The nLight ECLYPSE series is a modular and scalable platform that is used to control a wide range of HVAC applications. It supports BACnet/IP communication and is a listed BACnet Building Controller (B-BC).

The nECY Series Controller consists of an automation and connectivity server, power supply, and I/O extension modules.

This programmable Connected System Controller provides advanced functionality such as customizable control logic, Web-based design and visualization interface (ENVYSION embedded), logging, alarming, and scheduling.

This user guide also explains how to configure the nLight ECLYPSE controller's configuration interfaces.

Network Security

Maintaining the highest level of network security, especially when IP devices are connected to the Internet requires specially-trained personnel who are aware of the necessary techniques to ensure continued protection. This must

include the implementation of a Virtual Private Network (VPN) to connect with IP controllers over the Internet. It is also important to coordinate with Information Technology (IT) department personnel the use of shared network resources.

At the first connection to an nLight ECLYPSE Controller you will be forced to change the password to a strong password for the admin account to protect access to the controller.

Intended Audience

This user guide is intended for system designers, integrators, electricians, and field technicians who have experience with control systems, and who want to learn about how to make a successful IP network installation. It is recommended that anyone installing and configuring the devices specified in this user guide have prior training in the usage of these devices.

Conventions Used in this Document

Notes



This is an example of Note text. Wherever the note-paper icon appears, it means the associated text is giving a time-saving tip or a reference to associated information of interest.

Cautions and Warnings



This is an example of Caution or Warning text. Wherever the exclamation icon appears, it means that there may be an important safety concern or that an action taken may have a drastic effect on the device, equipment, and/or network if it is improperly carried out.

Acronyms and Abbreviations Used in this Document

Acronym	Definition
ASHRAE	American Society of Heating, Refrigeration, and Air-Conditioning Engineers
AP	Access Point
APDU	Application Protocol Data Units
API	Application Programming Interface
ASCII	American Standard Code for Information Interchange
BACnet®	Building Automation and Control Networking Protocol
BAS	Building Automation System
B-BC	BACnet Building Controller
BBMD	BACnet/IP Broadcast Management Device
CIDR	Classless Inter-Domain Routing
DHCP	Dynamic Host Configuration Protocol
DNS	Domain Name System
EOL	End Of Line
FTP	File Transfer Protocol
HTML	HyperText Markup Language
HTTP	Hypertext Transfer Protocol
HTTPS	Hypertext Transfer Protocol Secure
HVAC	Heating, Ventilating, and Air Conditioning
ID	Identifier
IP	Internet Protocol
IPv4	Internet Protocol version 4
ISP	Internet Service Provider
IT	Information Technology
LAN	Local Area Network
MAC	Media Access Control
MB	Megabyte
MHz	Megahertz

Acronym	Definition
MS/TP	Master-Slave/Token-Passing
NAT	Network Address Translation
NTP	Network Time Protocol
PC	Personal Computer
RADIUS	Remote Authentication Dial-In User Service
REST	Representational State Transfer
RTU	<i>Remote Terminal Unit (for Modbus)</i>
SSID	Service Set IDentification
TCP	Transmission Control Protocol
UDP	User Datagram Protocol
URL	Uniform Resource Locator
USB	Universal Serial Bus
VPN	Virtual Private Network
WAN	Wide Area Network
WPA	Wi-Fi Protected Access
WWW	World Wide Web

CHAPTER 2

INTERNET PROTOCOL SUITE FUNDAMENTALS

This chapter describes the Internet protocol operating principles necessary to configure the IP parameters of an IP controller.

Topics

[*About the Internet Network*](#)

[*Internet Protocol Suite Overview*](#)

About the Internet Network

The Internet is the world-wide interconnection of networks. At its root however, it is not one big network, but a group of networks that communicate between each other by using standard protocols and by using gateways between these networks called routers.

The structure of the Internet is decentralized and non-hierarchical. On the Internet, all communication uses the Internet Protocol (IP) to communicate and all connected devices are identified by their IP address. An Internet Registry allocates IP addresses to internet service providers to be used by their users.

Data is sent across the network in packets. Each packet has a header that identifies the sender's and intended receiver's IP addresses.

Internet Protocol Suite Overview

Internet Protocol (IP) is part of a multi-layered suite that together enables data communication. The following descriptions are an overview of the IP suite protocol layers as used by IP devices:

- Physical layer (bits): This is the physical and device-to-device electrical connection layer otherwise known as Ethernet. This layer defines:
 - The requirements for the physical connection between devices (the signal medium). For example, RJ-45 connectors (attached per TIA/EIA-568-A.), using Cat 5e data cable. The maximum cable length between devices is 328 ft. (100 m) at 100 MB/s data rate.
 - The electrical signal requirements for data packet transport.
 - The data packet structure including data payload and the source and destination device's MAC addresses.

In the case of Wi-Fi connected devices, the link layer is the air interface defined by the Wi-Fi standard, such as radio frequencies, data rates, authentication, data channel encryption, and so on.

- Data Link layer: This layer implements the ability for two devices to exchange data with each other.
- Network layer: This layer implements the ability to connect multiple distinct networks with each other. It provides the internetworking methods that allow data packets to travel from the source device to a destination device across network boundaries, such as a router through the use of an IP address. See
- Transport Layer (segments): This layer provides end-to-end communication data stream connection between two or more devices through a variety of protocols. However
 - , it is the Transmission Control Protocol (TCP), the most commonly used internet transport protocol that is used by Distech Controls IP controllers to communicate with each other. TCP creates a connection-oriented channel between two applications; that is to say the data stream is error-checked, is sorted into the correct sequence (missing data packets are retransmitted) and this data stream has a port number for addressing a specific application at the destination host computer.
- Session layer (data): This layer implements the protocol to open, close, and manage a session between applications such that a dialog can occur.
- Presentation layer: This layer implements the display of media such as images and graphics.
- Applications layer: This layer implements the process-to-process communications protocol that includes among other services the BACnet/IP protocol, programming, debugging, WWW, and so on.

All of the above IP suite protocol layers must be fully functional for any two devices or controllers to communicate with each other.

CHAPTER 3

IPv4 COMMUNICATION FUNDAMENTALS

This chapter describes IPv4 Communication operating principles.

Topics

DHCP versus Manual Network Settings

Networking Basics

About Routers, Switches, and Hubs

DHCP versus Manual Network Settings

About Routers, Switches, and Hubs

The differences between a hub, switch, and router are discussed in the table below.

Table 1: Difference between a Hub, Switch, and Router

Device Type	Description
Hub	Every incoming data packet is repeated on every other port on the device. Due to this, all traffic is made available on all ports which increase data packet collisions that affect the entire network, thus limiting its data carrying capacity.
Switch	A switch creates a one-to-one virtual circuit that directs IP packets directly to the port that the destination computer is connected to. A switch maintains a lookup table that contains the MAC addresses of all the devices that are connected to the switch ports. The switch always refers to its lookup table before it forwards data packets to the destination devices.
Router	Like a switch, a router learns the IP addresses of all devices connected to any of its RJ-45 ports to create a routing table. If a data packet arrives at the router's port with a destination IP address that is: <ul style="list-style-type: none"> • Found in the router's routing table, the router forwards the data packet to the appropriate port for the device that has this IP address. • For a network with a different network ID than the current network ID, the router forwards the data packet to the uplink port where the next router will again either recognize the network ID and route the data packet locally or again forwards the data packet to the uplink port. By being exposed to traffic, a router adds to its routing table the pathways necessary to resolve a data packet's pathway to its final destination, by passing through one or more routers if necessary.

Connecting a Router

The way a router is connected to other devices changes its function.

Figure 2: The Way a Router is Connected Changes its Function

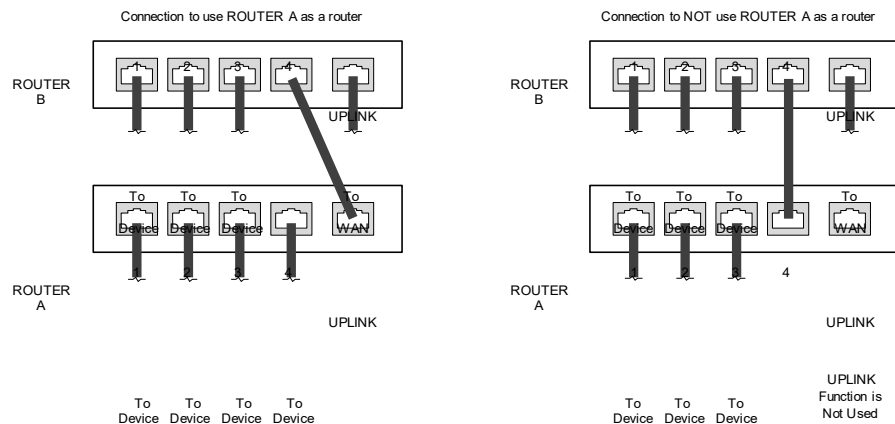

On some routers, the uplink port is marked as WAN (Wide Area Network) and the numbered ports are to be connected to the LAN (Local Area Network) devices.

Network Address Translation / Firewall

A router's uplink port provides Network Address Translation (NAT) and firewall functions.

NAT is a method to hide the private IP addresses of a range of devices (connected to LAN ports) behind a single IP address presented at the WAN uplink port. NAT uses a mechanism to track requests to WAN IP addresses and readdresses the outgoing IP packets on exit so they appear to originate from the router itself. In the reverse communications path, NAT again readdresses the IP packet's destination address back to the original source private IP address.

Due to this tracking mechanism, only requests originating from the LAN side can initiate communications. A request from the WAN to the router cannot be mapped into a private address as there is no outbound mapping for the router to use to properly readdress it to a private IP address. This is why a NAT acts as a firewall that blocks unsolicited access to the router's LAN side.

Most routers allow you to open a port in the firewall so that WAN traffic received at a specific port number is always forwarded to a specific LAN IP address. The standard port numbers used by nLight ECLYPSE controllers is explained in chapter [nLight ECLYPSE Controller IP Network Protocols and Port Numbers](#).

IP Network Segmentation

For efficient network planning, normally the IP controllers will be assigned to their own network segment of an IP network or subnetwork. This is done as shown in the figure below.

Figure 3: Network Segment for HVAC IP Controllers

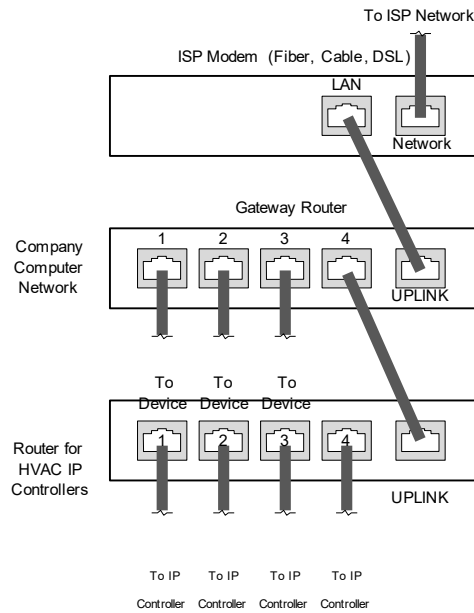

For certain wireless topologies, a wireless router can be used to connect nLight ECLYPSE controller. In this scenario, a wireless operator interface (laptop or tablet) can be used for commissioning as shown in the figure below. If the laptop has a Supervisor installed, it can be used to program ECB series controllers connected to the RS-485 port of the Connected System Controller.

Figure 4: Network Segment for HVAC IP Controllers with a Wireless Access Point

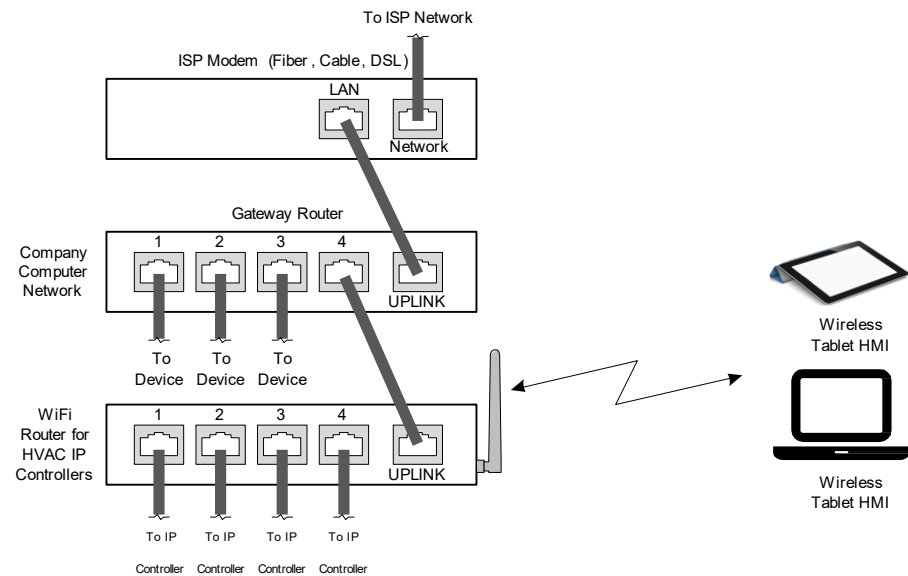

If a wireless router is unavailable or is out-of-range, an nLight ECLYPSE Wi-Fi adapter can be connected to an nLight ECLYPSE controller's USB port to add wireless connectivity. See [Wireless Network Connection](#).

CHAPTER 4

nLight ECLYPSE CONTROLLER IP NETWORK PROTOCOLS AND PORT NUMBERS

This chapter describes the IP Network Protocols and Port Numbers used by the nLight ECLYPSE controller.

Topics

[About Port Numbers](#)

[nLight ECLYPSE IP Network Port Numbers and Protocols](#)

[nLight ECLYPSE Services that Require Internet Connectivity](#)

About Port Numbers

In an IP packet, a port number is an extension of the packet's IP address and completes the destination address for a communications session. By convention, the packet's port number is associated with a protocol used between software applications and is used to uniquely identify a communications endpoint for a specific application or process running on a computer. This allows a multitude of applications to share a single physical connection to the Internet while allowing distinct communication channels between different applications.

For example, your web browser listens to port 80 on your computer to receive HTML web pages sent from a web server on port 80.

The standard port numbers used by nLight ECLYPSE controllers is explained in [nLight ECLYPSE IP Network Port Numbers and Protocols](#).

Sometimes, two applications might use the same port number to communicate. To sort out this conflict, the following methods can be used.

- In the configuration of some applications, the port number can be changed from its default setting. Should you change it, you must also change it on the corresponding application also so that the port numbers will match.
- Routers have features such as port forwarding that can change an incoming packet's port number coming from the Wide Area Network (WAN) to another port number on the Local Area Network or vice versa.

nLight ECLYPSE IP Network Port Numbers and Protocols

nLight ECLYPSE uses the following IP Network Protocols to communicate over IPv4 networks. The corresponding default in-bound port number is also shown.

Service	Default Port Number (Protocol)	Description	Where can this port number be changed?
SMTP	25 (TCP)	Outgoing Email server port number.	See the EC-gfx Program User Guide , Resources Configuration.
DNS	53 (TCP, UDP)	Domain Name Server URL lookup.	–
DHCP	67 (UDP)	The router's DHCP service that allows a device to auto-configure a devices' IP settings.	–
HTTP	80 (TCP)	<p>EC-gfx Program Debugging Values (REST service): After the control logic or code has been sent to the controller, a live debugger allows programmers to execute code, view input/output values, and troubleshoot errors in real-time.</p> <p>ENVYSION: The ENVYSION server presents system status, trending visualization, real-time equipment visualization, schedule configuration, alarm monitoring, and dashboard functions to a Web browser operator interface.</p> <p>Web Configuration Interface: This is the network configuration interface for wired and wireless IP network interfaces.</p>	See System Settings . If this is used with EC-Net, this parameter can be changed in the RestService and WebService .

Service	Default Port Number (Protocol)	Description	Where can this port number be changed?
HTTPS	443 (TCP)	<p>Secure EC-gfx Program Debugging Values (REST service): After the control logic or code has been sent to the controller, a live debugger allows programmers to execute code, view input/output values, and troubleshoot errors in real-time.</p> <p>Secure ENVYSION: The ENVYSION server presents system status, trending visualization, real-time equipment visualization, schedule configuration, alarm monitoring, and dashboard functions to a Web browser operator interface.</p> <p>Secure Web Configuration Interface: This is the network configuration interface for wired and wireless IP network interfaces.</p>	See System Settings . If this is used with EC-Net, this parameter can be changed in the RestService and WebService .
Radius Server	1812 (UDP)	Authentication Port: This is the port on which authentication requests are made.	
Radius Server	1813 (UDP)	Accounting Port: This is the port on which accounting requests are made. This is only used to receive accounting requests from other RADIUS servers.	
Radius Server	1814 (UDP)	Proxy Port: This is an internal port used to proxy requests between a local server and a remote server.	See User Management . If this is used with EC-Net, these parameters must be set in the RadiusService.
BACnet/IP	47808 (UDP)	The BACnet over IP protocol.	See BACnet Settings
MQTT	8883(TCP)	SecureMQTelemetryTransport. This is an internal port that facilitates communication with the nLight Gateway.	

nLight ECLYPSE Services that Require Internet Connectivity

In order to operate, the following out-bound services require:

- A working DNS. See [Domain Name System \(DNS\)](#).
- The default gateway / router to be configured. See [Default Gateway](#).
- Internet connectivity.

The corresponding default out-bound port number is also shown.

Service	Default Port Number (Protocol)	Description
SMTP	25 (TCP)	Outgoing Email server port number.
Network Time Protocol (NTP)	123 (UDP)	Used to set the controller's real time clock.
DNS server	53 (UDP, TCP)	Used to provide URL name resolution. The controller by default uses an internet DNS. If the local network has a DNS, set its IP address in Network Settings .

CHAPTER 5

CONNECTING IP DEVICES TO AN IP NETWORK

An IP network requires infrastructure such as Ethernet cable, routers, switches, or Wi-Fi hotspots in order to work. The following topics discuss the fundamentals of such a network.

Topics

[*Connecting the IP Network*](#)

[*Wireless Network Connection*](#)

[*Wireless Network Commissioning Architectures*](#)

Connecting the IP Network

There are two methods to connect a device to an IP Network:

- Wired (Ethernet connection with the PRI and SEC ports).
- Wireless (when the nLight ECLYPSE Wi-Fi Adapter is connected to the controller).

Wired Network Cable Requirements

Wired networks use commonly available Cat 5e structural cabling fitted with RJ-45 connectors. If you make your own patch cable, use Category 5e cable and crimp the RJ-45 connectors at both ends of the cable either as T568A or T568B.

Table 2: Wired Network Cable Physical Specifications and Requirements

Parameter	Details
Media	Cat 5e Cable; four (4) pairs of wires with RJ-45 Connectors (standard straight patch cable)
RJ-45 Pin Configuration	Straight-through wiring. Crimp connectors as per T568A or T568B (both cable ends must be crimped the same way).
Characteristic impedance	100-130 Ohms
Distributed capacitance	Less than 100 pF per meter (30 pF per foot)
Maximum Cat 5e Cable length between IP devices	328 ft. (100 m) maximum. See About the Integrated Ethernet Switch .
Polarity	Polarity sensitive
Multi-drop	Daisy-chain (no T-connections) nLight ECLYPSE IP devices have two RJ-45 female RJ-45 connectors that provide IP packet switching to support follow-on devices.
Daisy-chain limit, Connected System Controllers	Up to 20 devices can be daisy-chained per network switch port.
Daisy-chain limit, Connected VAV Controllers	Up to 50 devices can be daisy-chained per network switch port.
EOL terminations	Not applicable
Shield grounding	Not applicable

Table 3: Distech Controls Recommended Cable Types to use for the Cat 5e Cable Subnetwork Bus

Bus and Cable Types	Non-Plenum Applications (Use in Conduit - FT4)		Plenum Applications (FT6)	
	Part Number	O.D. (Ø) ¹	Part Number	O.D. (Ø) ¹
300 m (1000 feet), Cat 5e Yellow Jacket Cable - Without Connectors	CB-W244P-1446YLB	4.6mm (0.18in.)	CB-W244P-2175YEL	4.6mm (0.18in.)
100 Crimp RJ 45 Connectors	CB-W5506E	N/A	CB-W5506E	N/A

1. Outer cable diameter – This does not take into account the RJ-45 connector.

About the Integrated Ethernet Switch

The 2-port wired interface uses a switch to forward packets addressed to downstream IP devices connected to it. This allows controllers to be daisy-chained together to extend the IP network's physical range and to reduce the amount of network cable required as each controller no longer has to make a home run to the network switch

Figure 5: Wired Network Connection: Daisy-Chained nLight ECLYPSE Controllers

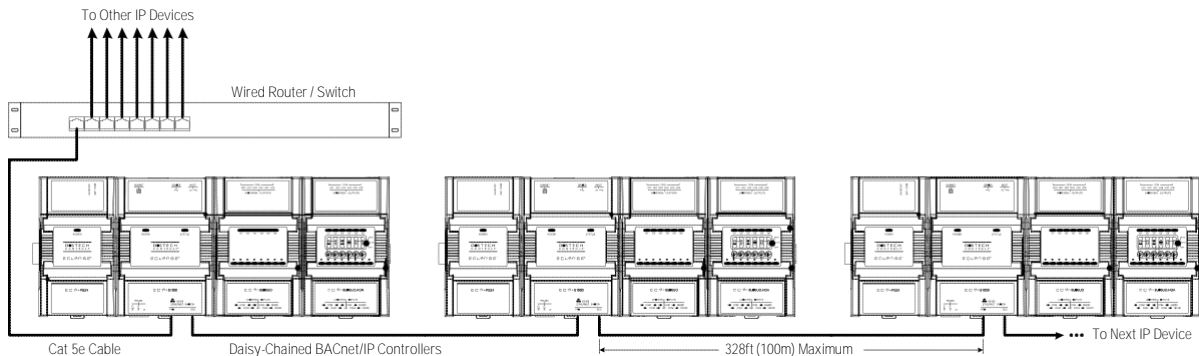

Spanning Tree Protocol

Switches and routers that support Spanning Tree Protocol (are IEEE 802.1D certified) are able to detect and eliminate a loop from being formed on the network by disabling any port on the router that is causing a loop. Such switches can be used to enhance network availability by allowing you to create a ring network of controllers that is resistant to a single point network failure (a cut wire for example).

In this scenario, controllers are connected in a loop (or ring) such that the last controller is connected back to the switch / router. Under normal operation, the switch / router disables one of the ports to prevent a packet storm. This is shown below.

Figure 7: Wired Network Connection: Spanning Tree Protocol – Normal Operation

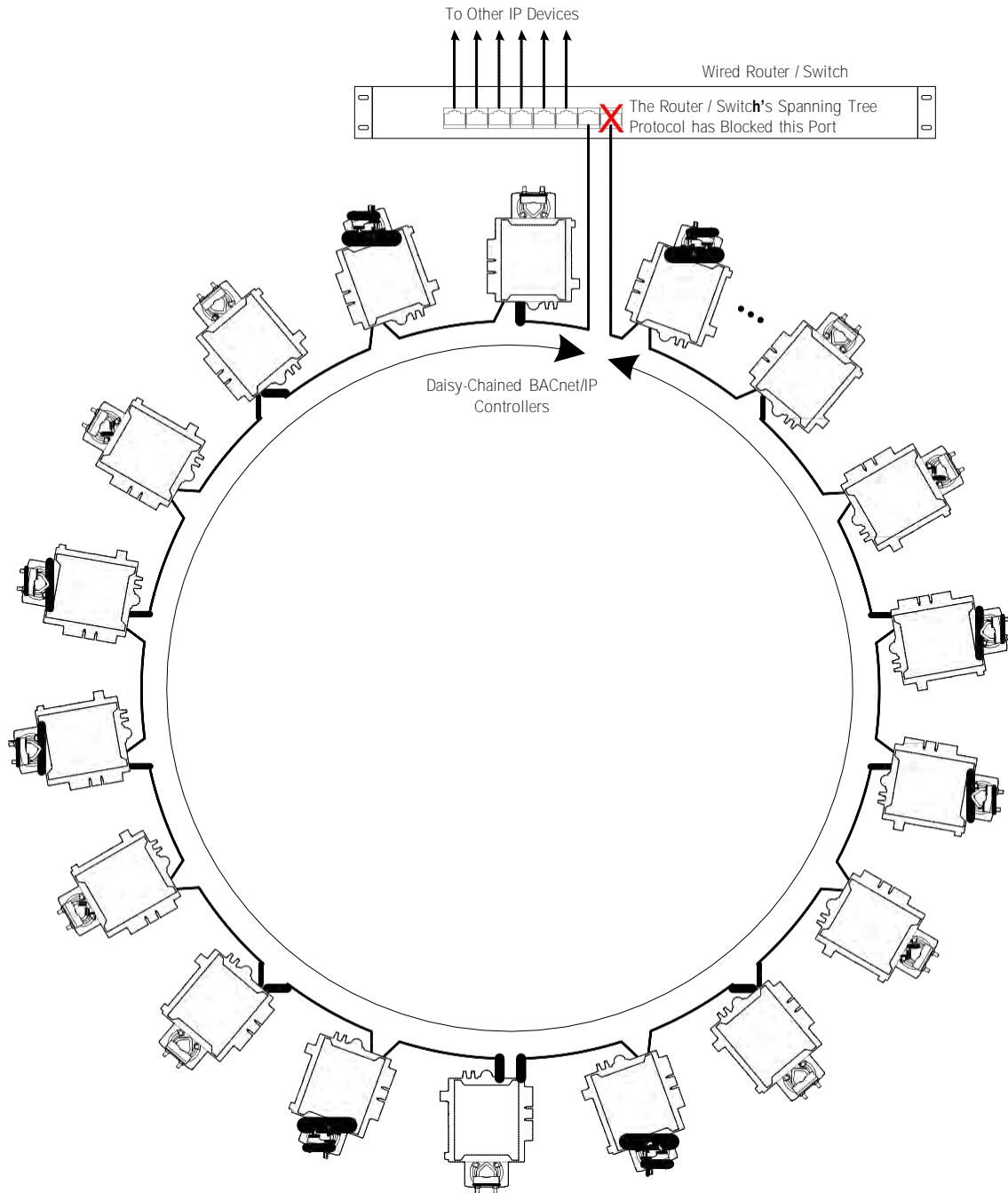

When a network wire is cut, the ring is split into two – the switch / router automatically enables the port to maintain service. This is shown below.

Figure 8: Wired Network Connection: Spanning Tree Protocol – Failover Operation

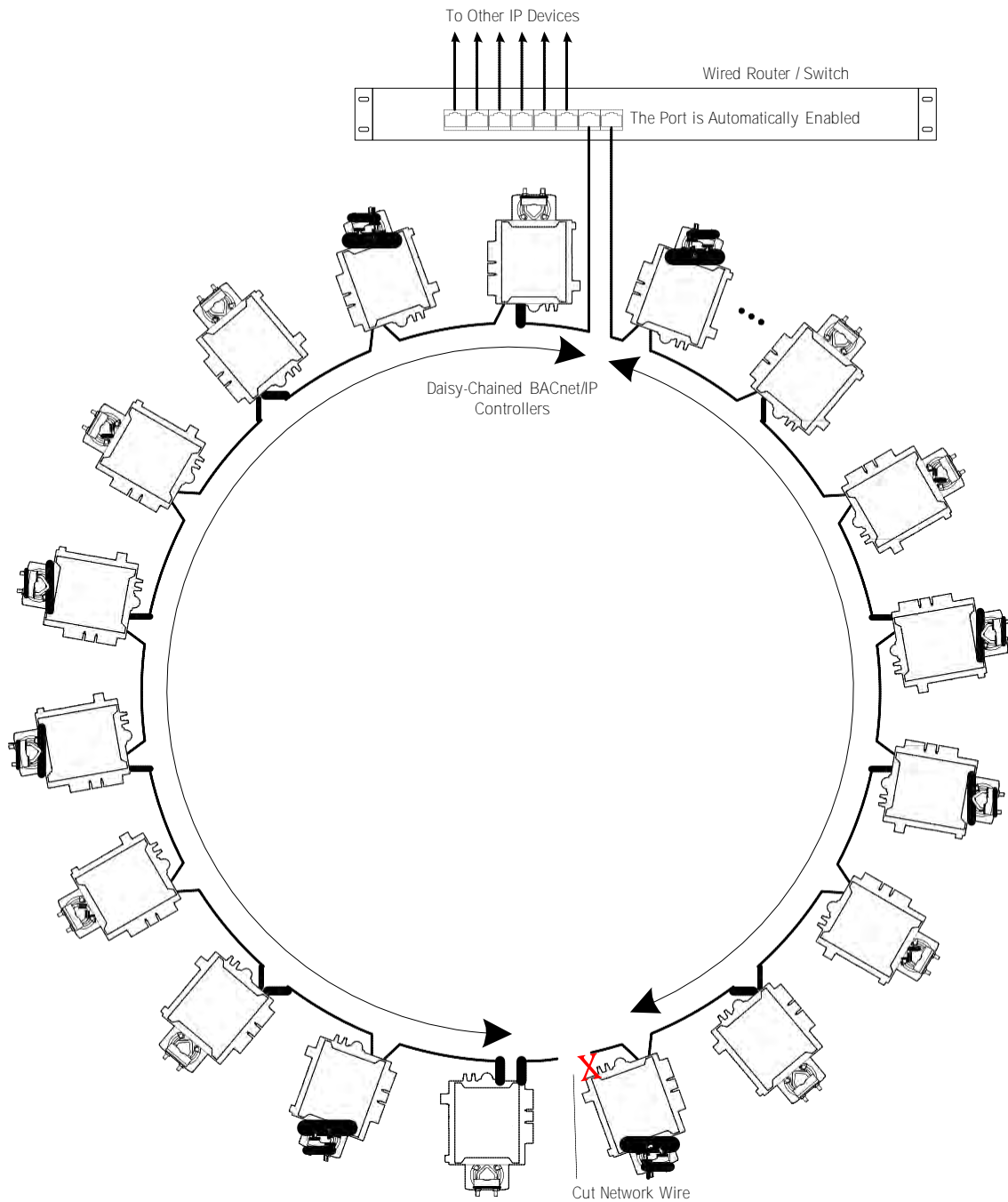

The switch / router can be configured to send an email message when port blocking is disabled thus signaling that a network wire has been cut.

Connecting the Network Cable to the nLight ECLYPSE Controller

To connect controllers to an Ethernet network and then discover them, see chapter [First Time Connection to an nLight ECLYPSE Controller](#).

Wireless Network Connection

The nLight ECLYPSE Wi-Fi adapter connects to an nLight ECLYPSE controller's USB port.

Figure 9: nLight ECLYPSE Wi-Fi Adapter



It adds wireless IP connectivity to nLight ECLYPSE controllers and it can be used in a number of wireless topologies and applications.

Recommendations are provided regarding the radio signal obstructions and factors that should be avoided to obtain the best Wi-Fi radio signal transmission and reception. Walls attenuate radio wave propagation by an amount that varies with the construction materials used. See [Radio Signal Transmission Obstructions](#) for more information on wall materials that can reduce range transmission.

About the 2.4 GHz ISM band

The 2.4 GHz ISM (Industrial, Scientific and Medical) band has been allocated worldwide for the use of radio frequency energy by industrial, scientific, and medical purposes as part of the device's method of internal operation and as such may have powerful emissions that cause interference to radio communications.

For example, microwave ovens operate in the 2.4 GHz ISM band with about 1000W emitted power and a fraction of a percent of that energy does leak from the oven. While this is not a health risk, Wi-Fi networks operate at even lower power levels to communicate and can be overwhelmed by this source of interference.

When setting up a 2.4 GHz band Wi-Fi network, you must take into consideration any equipment that operates in the 2.4 GHz ISM band such as medical and laboratory equipment. Other sources of interference are other telecommunications equipment such as cell phones, GSM/DECT, cordless phones, RFID reader, Bluetooth devices, walkie-talkies, baby monitors, and so on. Note that equipment that transmits in other frequency bands do emit spurious emissions at low levels over a wide spectrum so that a radio transmitter in close proximity to the nLight ECLYPSE Wi-Fi adapter can cause interference, even if its operating frequency is 1.9 GHz for example.

Figure 10: Typical Radio Transmitter Spurious Emissions

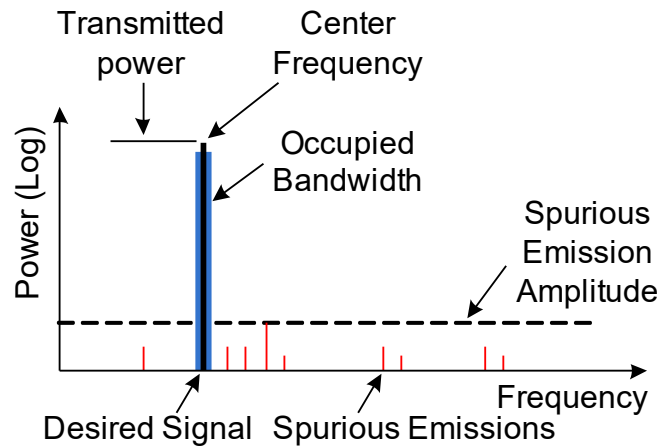

Distance between nLight ECLYPSE Wi-Fi Adapter and Sources of Interference

Unrelated transmitters should be more than 6.5 feet (2 m) away from the nLight ECLYPSE Wi-Fi Adapter to avoid possible interference.

About Wi-Fi Network Channel Numbers

Wi-Fi communications use a slice of radio spectrum or channel width for data transmission. In general terms, the amount of channel width required is proportional to the data transmission rate. Wi-Fi networks operate in a number of different frequency ranges or bands such as the 2.4 GHz band. Each band is divided into a number of industry-standard channels that represent a center frequency for data transmission. In practice, the center frequency is the midpoint between the upper and lower cutoff frequencies of the channel width.

When the channel width is larger than the channel spacing (the space between channels), overlap between the channels can occur, resulting in inter-channel interference that lowers overall network throughput. This is shown in the diagram below. For example, in the 2.4 GHz band using 802.11g, the channel width is 20 MHz while the channel spacing is 5 MHz. If one Wi-Fi network is using channel 1 that is in close proximity to another Wi-Fi network that is using channel 2, there will be significant inter-channel overlap and interference. Data throughput is reduced as a result.

Figure 11: 2.4 GHz Band 802.11g Radio Spectrum Showing Inter-Channel Overlap

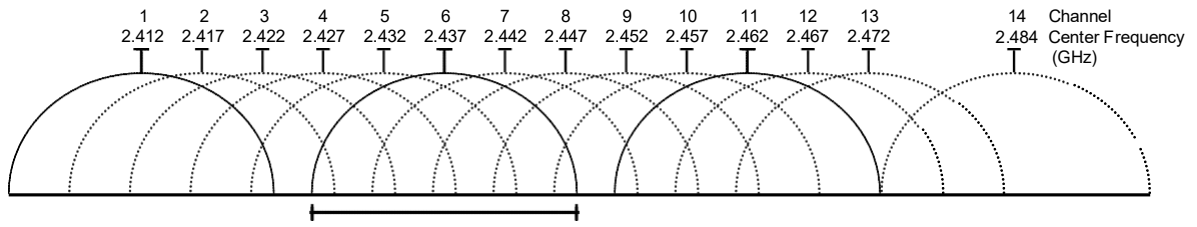

For a 20 MHz channel width in the 2.4 GHz band using 802.11g, the best channels to use to avoid inter-channel overlap are channels 1, 6, and 11. For a 40 MHz channel width in the 2.4 GHz band using 802.11g, the best channels to use to avoid inter-channel overlap are channels 3 and 11.

For a 20 MHz channel width in the 2.4 GHz band using 802.11n, the best channels to use to avoid inter-channel overlap are channels 1, 6, and 11. For a 40 MHz channel width in the 2.4 GHz band using 802.11g, the best channel to use to avoid inter-channel overlap is channel 3.

For industrial / commercial environments, it is recommended to avoid using a 40 MHz channel width in the 2.4 GHz band as it occupies a large part of the available radio spectrum. This means that it will be difficult to co-exist with other networks while avoiding interference, especially from devices that use mixed mode 802.11 b/g which significantly degrades 802.11n performance. One solution is to disable the 802.11 b/g mode on all hotspots to force all wireless clients to 802.11n mode, thereby forbidding the use of legacy devices.

Radio Signal Range

Radio Signal Transmission Obstructions

Where to Locate Wireless Adapters

When installing the wireless adapter, it is important to ensure that distances and obstructions do not impede transmission. Metallic parts, such as steel reinforcement in walls, machinery, office furniture, etc. are major sources of field strength dampening. Furthermore, supply areas and elevator shafts should be considered as complete transmission screens, see following figure.

Figure 12: Screening of Radio Waves

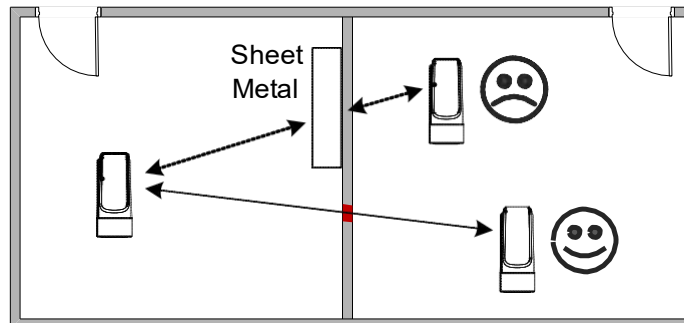

Transmission Obstructions and Interference

One way to get around an obstruction, such as a duct, is to place the wireless adapter on the side of the obstruction that is nearer to the coordinating wireless device, even if the controller is on the opposite side of the obstruction. But always keep in mind that the wireless adapter performs best when it is away from metal objects or surfaces (more than 1" (2.5 cm)).

In addition to obstructions, the angle with which the transmission travels through the obstruction has a major influence on the field strength. The steeper the angle through an obstruction, the radio wave has to travel through

more material resulting in the field strength reduction (See [Figure 13](#)). Therefore, it is preferable that the transmission be arranged so that it travels straight and perpendicularly through the obstruction.

Figure 13: Angle of Radio Waves

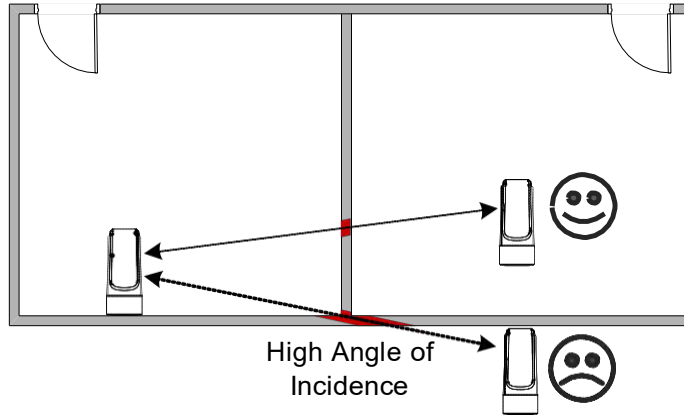

A solution to avoid an obstruction is to add another wireless router located closer to the controller(s).

nLight ECLYPSE Wi-Fi Adapter Mounting Tips

This section provides information and examples on how to properly position the nLight ECLYPSE Wi-Fi Adapter to ensure reliable wireless communication. The most common guidelines to remember when installing the nLight ECLYPSE Wi-Fi Adapter is to keep it at least 1" (2.5 cm) away from metal, and never install the nLight ECLYPSE Wi-Fi Adapter inside a metal enclosure (relay panels, junction box, etc.).

Typical Metal Relay Panel/Utility Box Installation

The following image shows where to install an nLight ECLYPSE Wi-Fi Adapter on a metal relay panel or utility box with a controller inside the panel/box. To maximize wireless range, the nLight ECLYPSE Wi-Fi Adapter must be installed on the top or side of the panel.

Figure 16: nLight ECLYPSE Wi-Fi Adapter Position with Metal Relay Panel/Utility Box

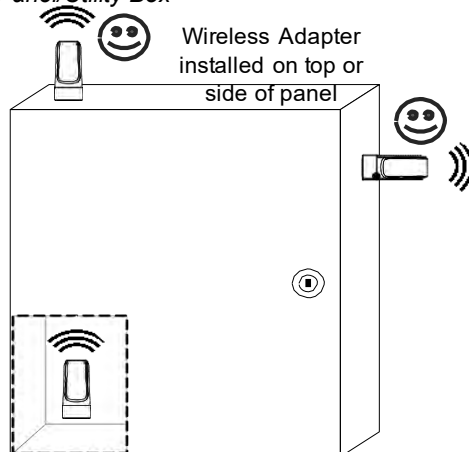



Wireless Adapter
NOT to be installed
inside the panel

Typical Fan Coil Unit Installation

The following example shows where to install an nLight ECLYPSE Wi-Fi Adapter on a fan coil unit with a controller inside the unit.

must be installed on the top or side of the unit with the antenna straightened out and away from the metal. The nLight ECLYPSE Wi-Fi Adapter and antenna should never be installed inside the metal enclosure.

Figure 17: nLight ECLYPSE Wi-Fi Adapter Position on Fan Coil Unit

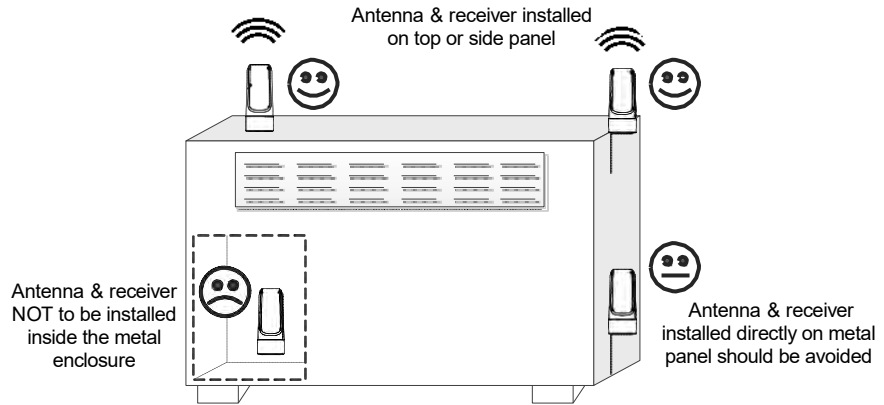

Planning a Wireless Network

A wireless network can be installed in many different types of floor spaces, large or small: office space, commercial space, residential space, etc. The following provides an example on how to start planning a wireless network such as a large office space. This type of planning can also be used with smaller areas.

1. Retrieve a copy of your floor plans and a compass.

Figure 18: Copy of floor plan and a compass

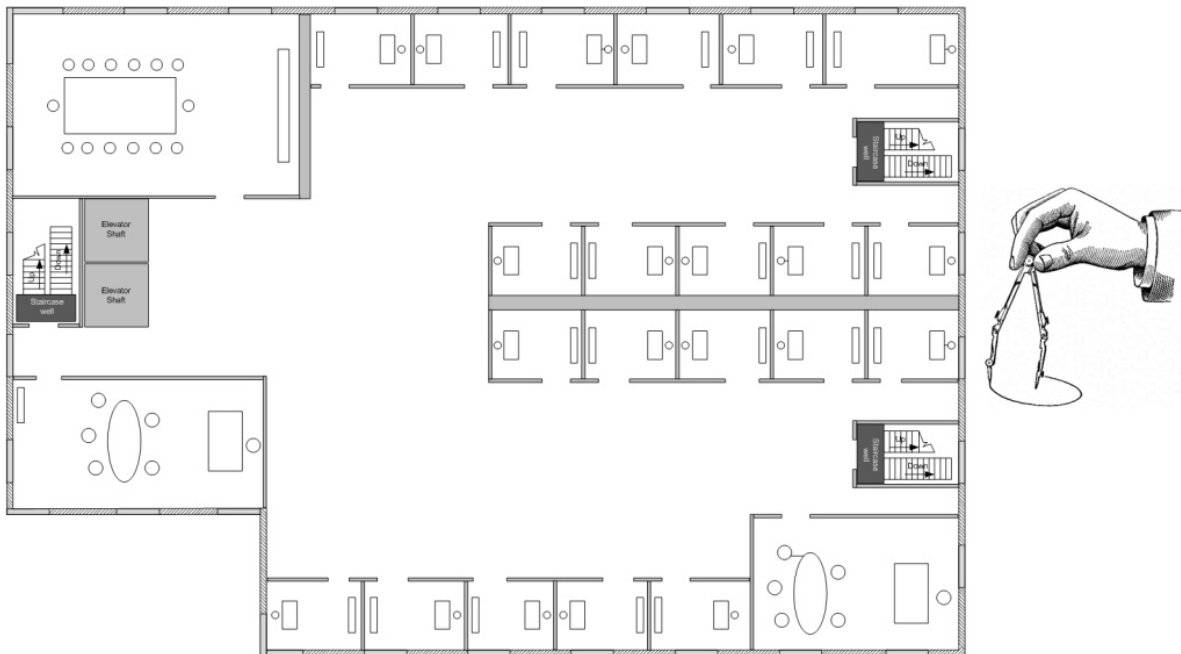

2. Mark relevant radio shadings into floor plan such as: fire protection walls, lavatories, staircases, elevator shafts and supply areas.

Figure 19: Mark relevant radio shadings

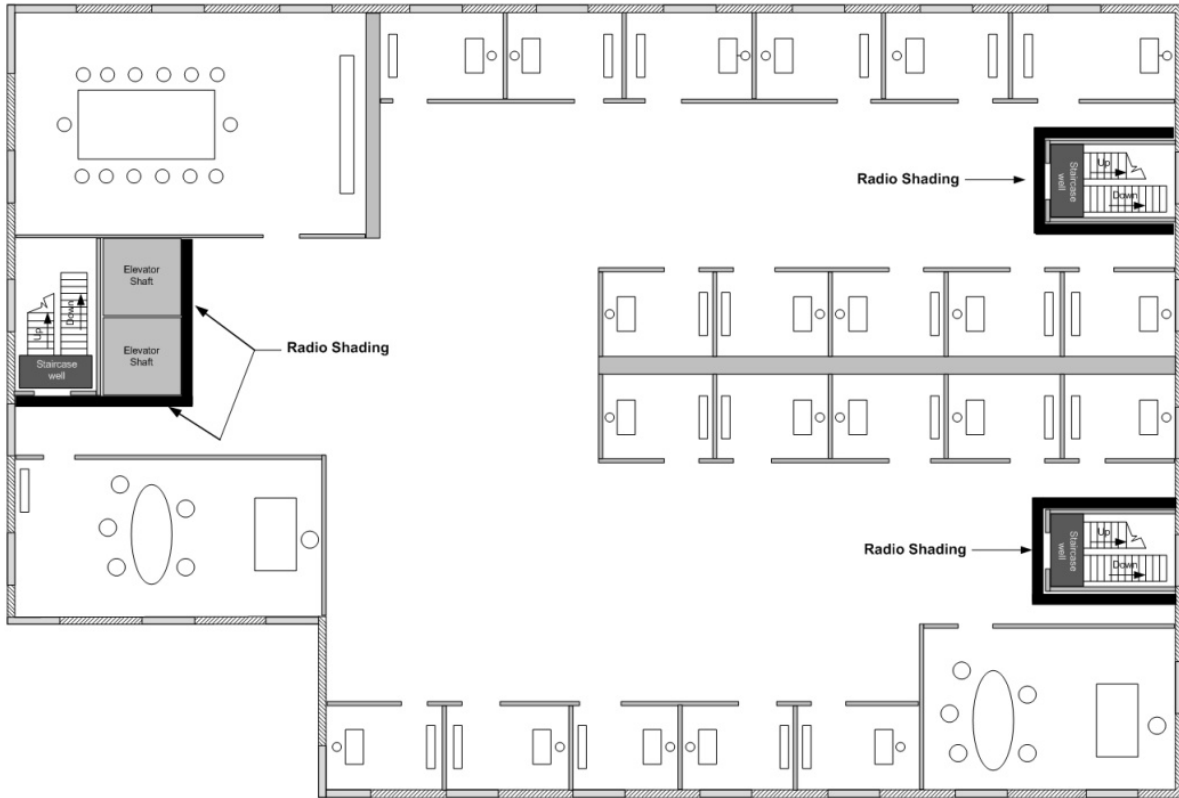

3. Draw circles to locate the ideal positions for your nLight ECLYPSE Wi-Fi Adapter as shown below:

Figure 20: Radio nLight ECLYPSE Wi-Fi Adapter Location

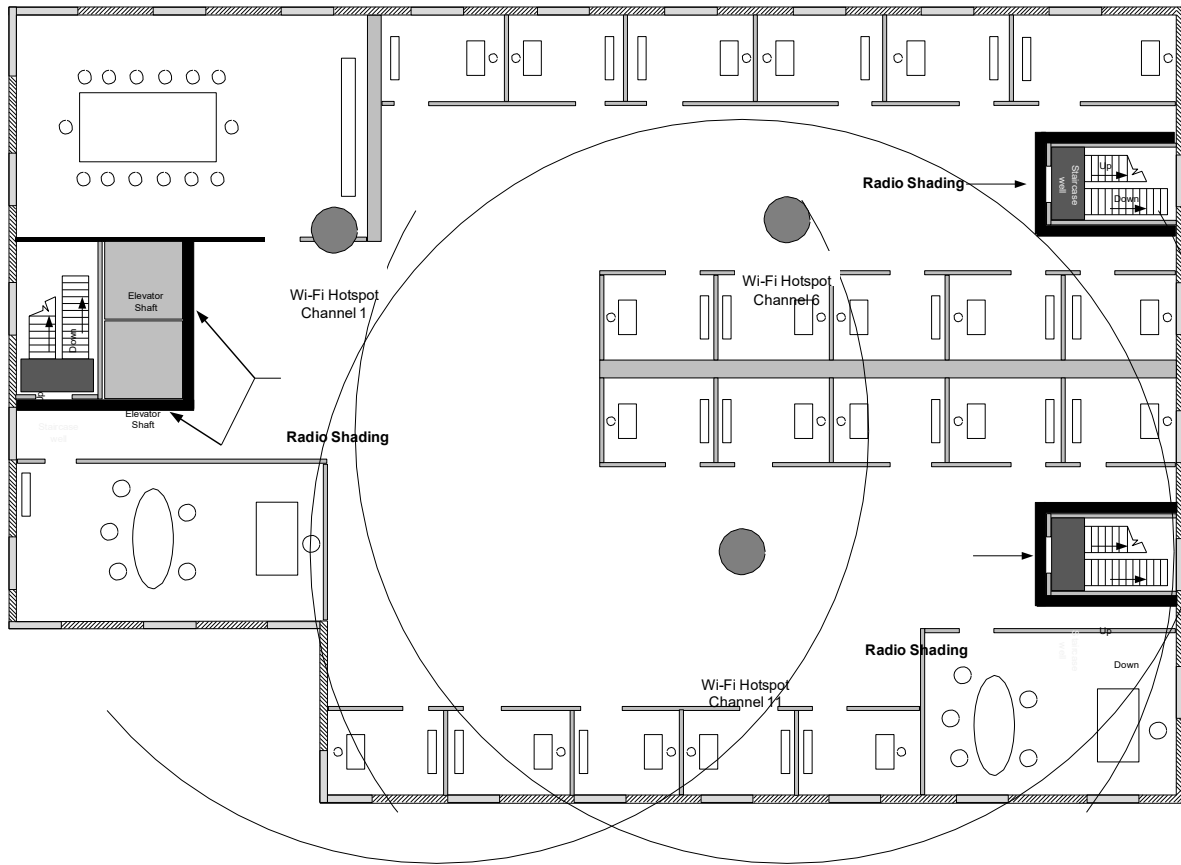

Make sure that the nLight ECLYPSE Wi-Fi Adapter is positioned in a way such that no screens block the connection to any corner inside the fire safety section (potential sensor positions).



For reliable range planning, the unfavorable conditions should be detected at the beginning but often come from later changes to the environment (room filled with people, alteration of partition walls, furniture, room plants, etc.).



Even after careful planning, range and signal tests should be done during installation to verify proper reception at the nLight ECLYPSE Wi-Fi Adapter positions. Unfavorable conditions can be improved by changing the antenna position or by adding a router closer to the controller(s).

nLight ECLYPSE Wi-Fi Adapter Connection Modes

nLight ECLYPSE Wi-Fi adapter supports a number of connection modes shown in the table below:

Connection Mode	Description	Max Number of Wireless Clients or Nodes
Client	<p>This sets the mode of the nLight ECLYPSE Wi-Fi adapter to connect the controller as a client of a Wi-Fi access point. This interface can auto-configure its IP parameters when the connected network that has a DHCP server.</p> <p>When an nLight ECLYPSE controller is a Wi-Fi client, the Ethernet ports can be used to provide network connectivity to another nLight ECLYPSE controller or to a laptop for example. Each connected device counts towards the “Maximum Number of Wireless Clients or Nodes”. See Wireless Bridge for more information.</p>	16
Access Point	<p>This sets the mode of the nLight ECLYPSE Wi-Fi adapter to be a Wi-Fi access point. This access point operates off of the same subnetwork and has the same IP connectivity that the controller has with its wired network connection. For example, if the controller’s wired connection is to a network that has an active DHCP server, access point clients can also use this DHCP server to automatically configure their IP connection parameters.</p>	16
Hotspot (default)	<p>This sets the mode of the nLight ECLYPSE Wi-Fi adapter to be a Wi-Fi hotspot with a router. This puts the hotspot into a separate subnetwork with a DHCP server to provide IP addresses to any connected device. Wide area network (WAN) connectivity is through the wired connection.</p>	16

Typical application examples are shown below.

Wi-Fi Client Connection Mode

Cut installation costs by leveraging existing wireless infrastructure and by eliminating the need for Ethernet cables. This architecture is characterized by the point-to-point connection between an access point and a client-controller.

Figure 21: Leveraging Existing Wireless Infrastructure by Eliminating Ethernet Cables

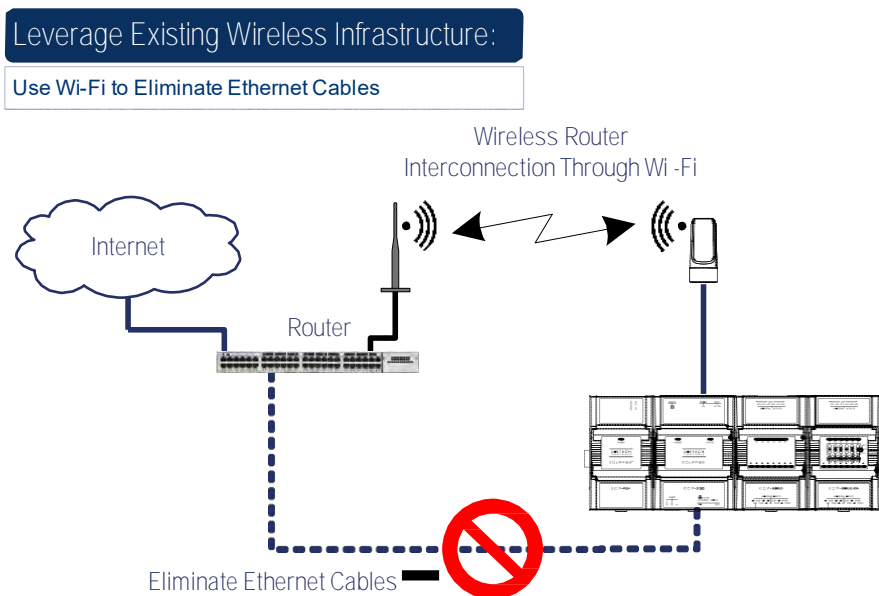

To configure the Wi-Fi client connection mode, see [Setting up a Wi-Fi Client Wireless Network](#).

Wi-Fi Access Point

Should there be no available access point; an nLight ECLYPSE controller can be configured as a wired-to-wireless bridge to create an access point which can provide Wi-Fi access to other Wi-Fi enabled clients. This access point operates off of the same subnetwork and has the same IP connectivity that the controller has with its wired network connection. The nLight ECLYPSE Wi-Fi adapter can also be temporarily added to an nLight ECLYPSE controller for wireless commissioning purposes. A variety of software applications are available for system monitoring and override, commissioning, configuration and programming.

Figure 22: Using an nLight ECLYPSE Controller Create an Access Point

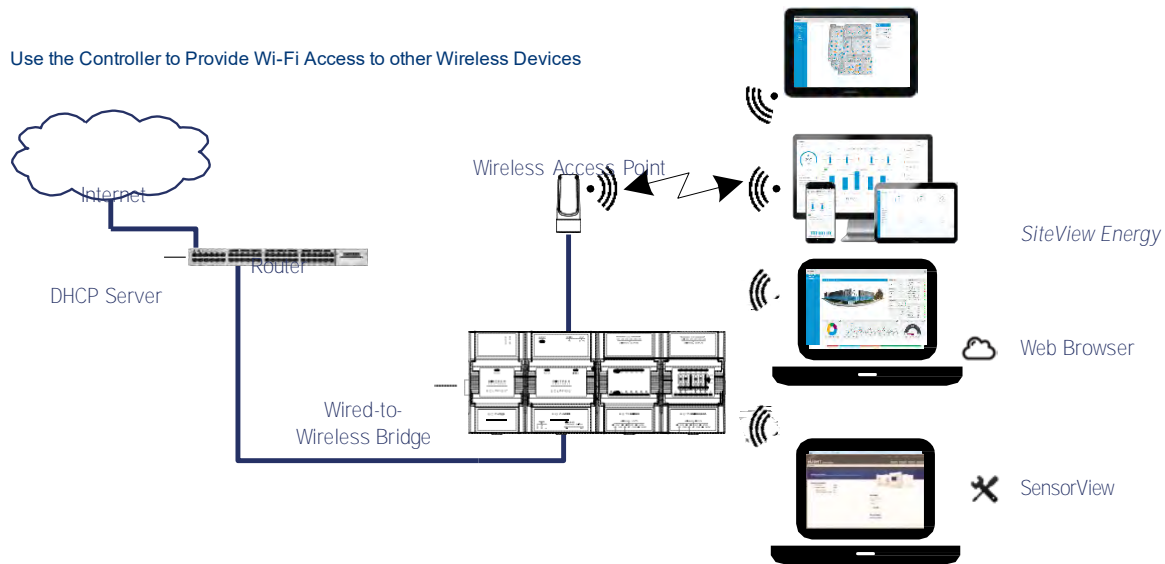

A second nLight ECLYPSE controller can be configured as a wireless client. This can be used as a solution to 'jump' architectural features that are not compatible with wires such as glass atrium and the like. To configure the Wi-Fi client connection mode, see [Setting up a Wi-Fi Client Wireless Network](#).

An access point can provide Wi-Fi access to other Wi-Fi enabled clients and controllers.

Figure 23: Using an nLight ECLYPSE Controller as a Wireless Bridge

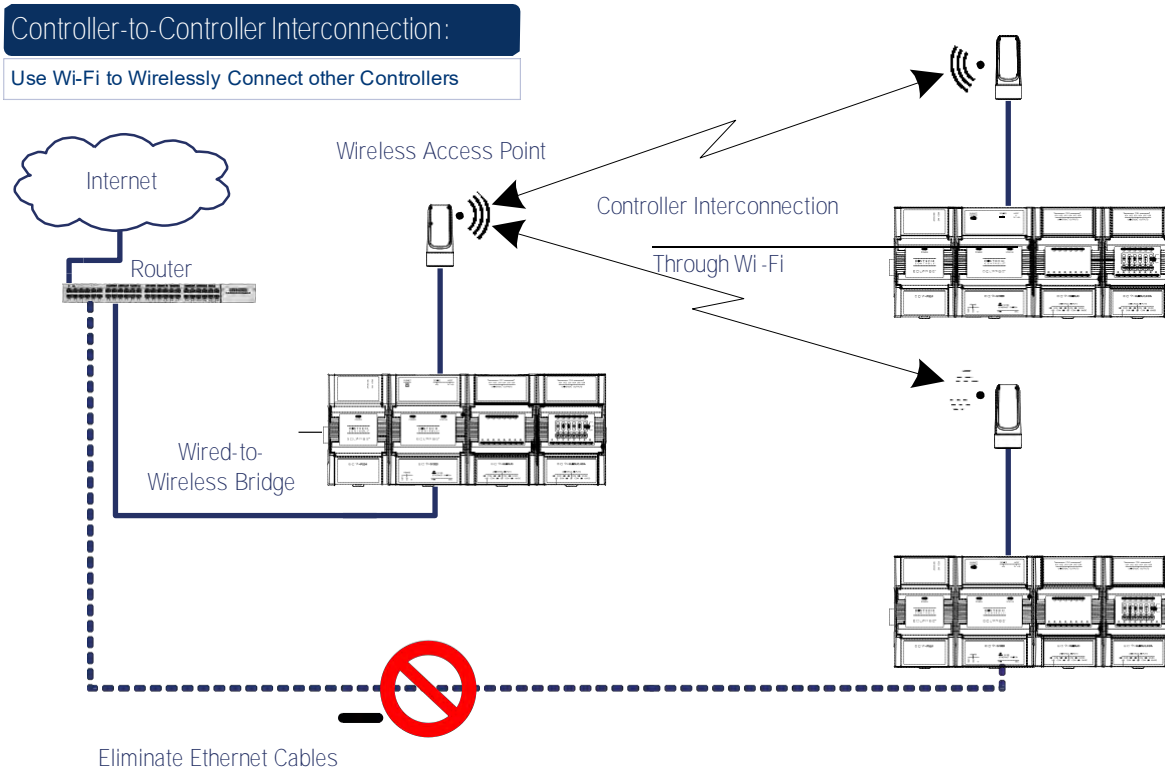

Wi-Fi Hotspot

Should the wired network not use a DHCP server (uses fixed IP addresses); an nLight ECLYPSE controller can be configured to create a hotspot with a router that creates its own subnet and DHCP server which can provide Wi-Fi access to other Wi-Fi enabled clients. This is the default connection method when an nLight ECLYPSE Wi-Fi adapter is connected to an nLight ECLYPSE controller. The nLight ECLYPSE Wi-Fi adapter can also be temporarily added to an nLight ECLYPSE controller for wireless commissioning purposes. A variety of software applications are available for system monitoring and override, commissioning, configuration and programming.



A hotspot creates a subnetwork. As a result, any connected BACnet device will not be able to discover BACnet devices on any other LAN subnetwork.

Figure 24: Using an nLight ECLYPSE Controller Create a Hotspot

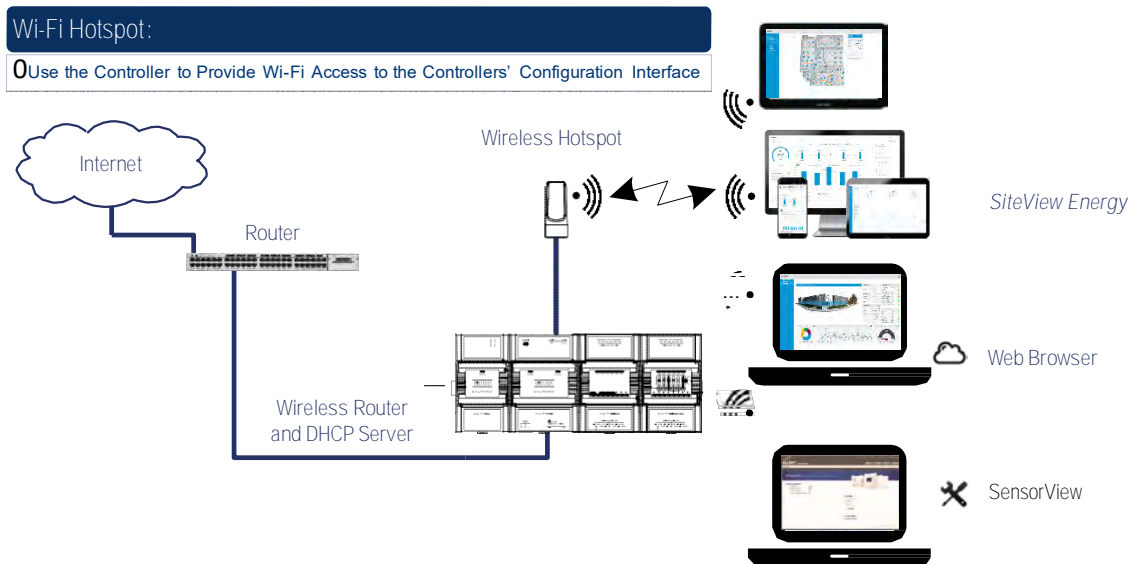

Wireless Bridge

A second nLight ECLYPSE controller can be configured as a wired-to-wireless bridge to allow the connection of wired IP devices to the bridged controller's Ethernet ports. This can be used as a solution to 'jump' architectural features that are not compatible with wires such as glass atrium and the like.

The access point / hotspot can provide Wi-Fi access to other Wi-Fi enabled clients.

Figure 25: Using an nLight ECLYPSE Controller as a Wireless Bridge

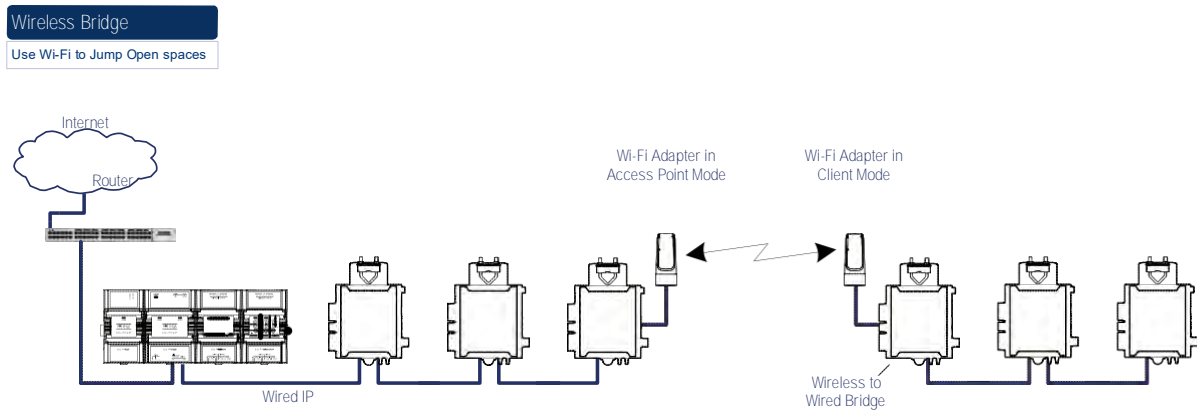

Maximum Number of Wireless Clients or Nodes for an Access Point

A wireless access point can service a maximum of 16 clients or nodes in total. The following examples show what this limit can be composed of:

- One wireless bridged controller is connected to as many as 15 daisy-chained wired devices.

Figure 26: Using an nLight ECLYPSE Controller as a Wireless Bridge

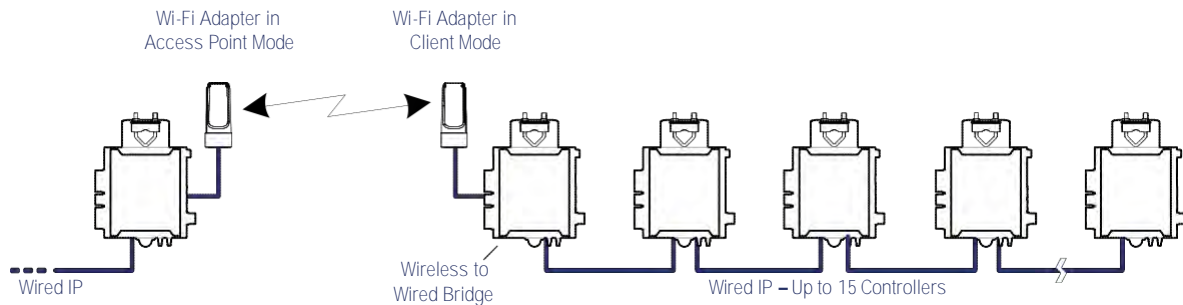

- One wireless bridged controller is connected to one wired controller that is wirelessly connected to one wireless bridge that is then connected 13 daisy chained wired devices.

Figure 27: Using an nLight ECLYPSE Controller as a Wireless Bridge

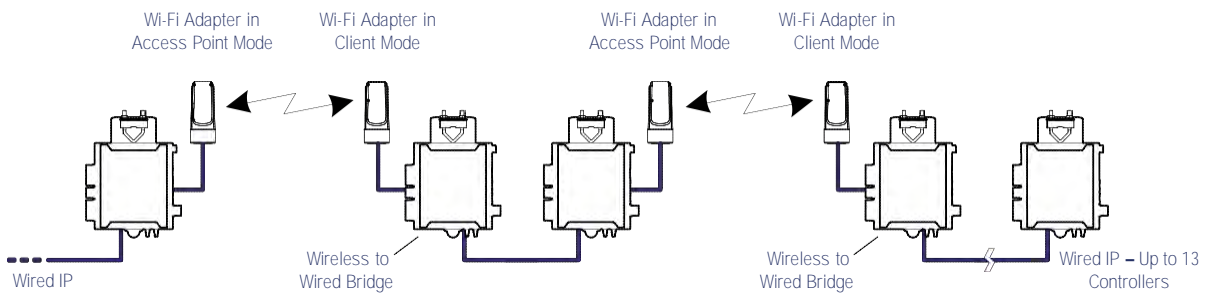

If the access point is a Wi-Fi router:

1. The number of devices is limited by the total number of clients the router is able to support.
2. It can support many controllers acting as wireless to wired bridges.
3. Each wireless to wired bridge controller can support up to 15 controllers.

Wireless Network Commissioning Architectures

Client to Access Point Configuration

A laptop is connected through Wi-Fi, as a Wi-Fi client, to any ECLYPSE Controller that has its wireless settings configured as an Access Point. The other ECLYPSE Controllers are configured as Wi-Fi Clients and are wirelessly connected to the same Access Point.

With this configuration, the laptop and all the nLight ECLYPSE controllers are on the same subnet, so either laptop user has access to all networked nLight ECLYPSE controllers.

Figure 28: Client to Access Point Configuration

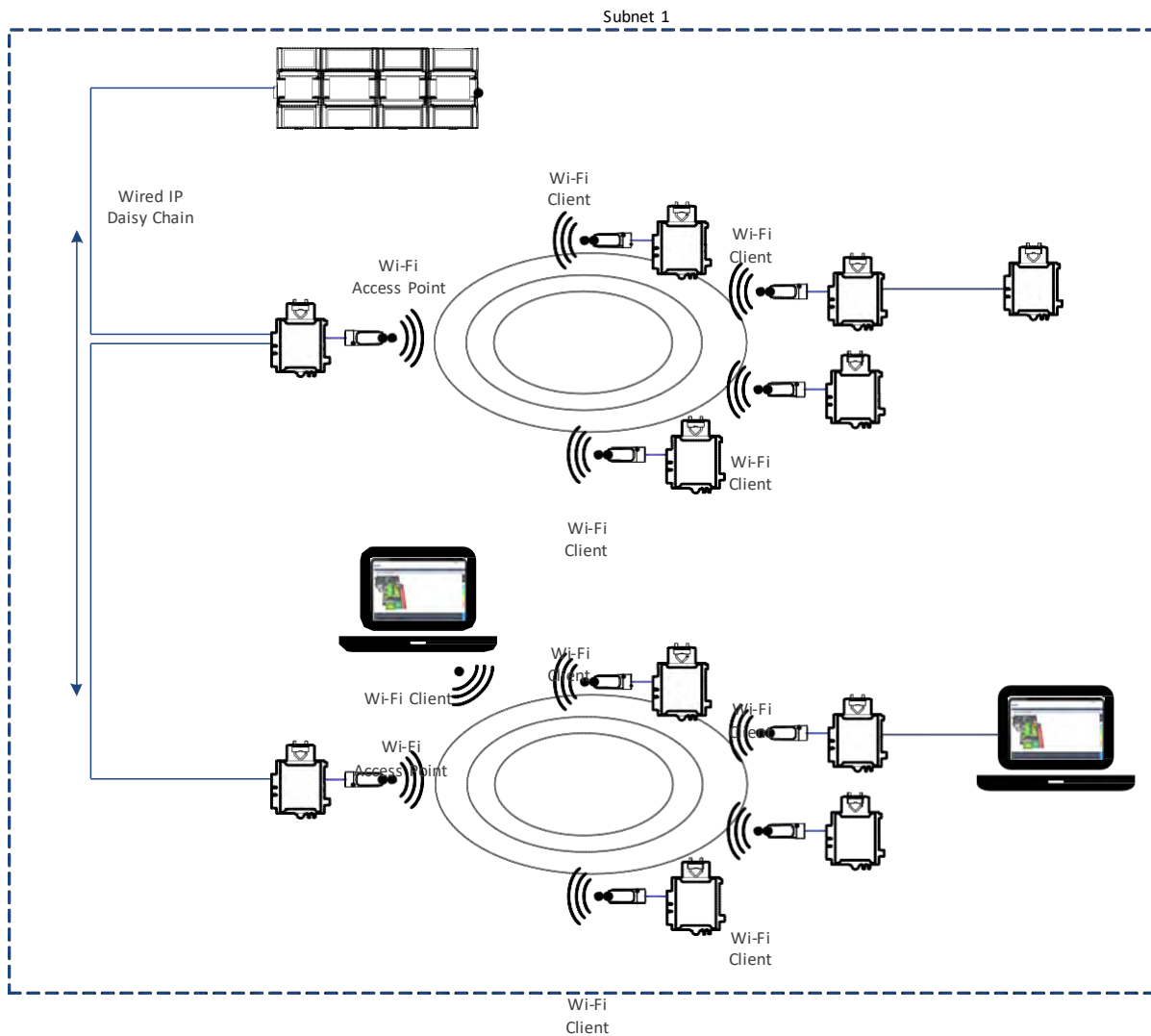

Client to Hotspot Configuration

Laptop 1 is connected as a Wi-Fi client to a Connected System Controller that has its wireless settings configured as a Hotspot (Subnetwork 2). The ECLYPSE Controllers that are part of the wired network are configured, on their wireless side as a Wi-Fi Access Point (Subnetwork 1).

The remaining ECLYPSE Controllers are configured as a Wi-Fi Client and are wirelessly connected to a VAV controller's Access Point.

With this configuration, laptop 1 is on the same subnet as the Connected System Controller (Subnetwork 2 created by the Hotspot), but all the Connected VAV Controllers are on a different Subnet (Subnetwork 1), so the laptop 1 user only has access to the Connected System Controller. This is because BACnet/IP broadcast discovery messages such as "Who-Is" do not pass through network routers that separate subnetworks. In the example shown below, the Connected System Controller acts as a router between the Wi-Fi hotspot clients and the wired network. This means that BACnet/IP controllers on different subnetworks will not normally communicate with each other. The laptop 2 user has access to both the ECLYPSE controllers and the Connected System Controller. A solution is to use BBMD on both Laptop 1 (using EC-Net for example) and on the Connected System Controller. See [BACnet/IP Broadcast Management Device Service \(BBMD\)](#).

Figure 29: Client to Hotspot Configuration

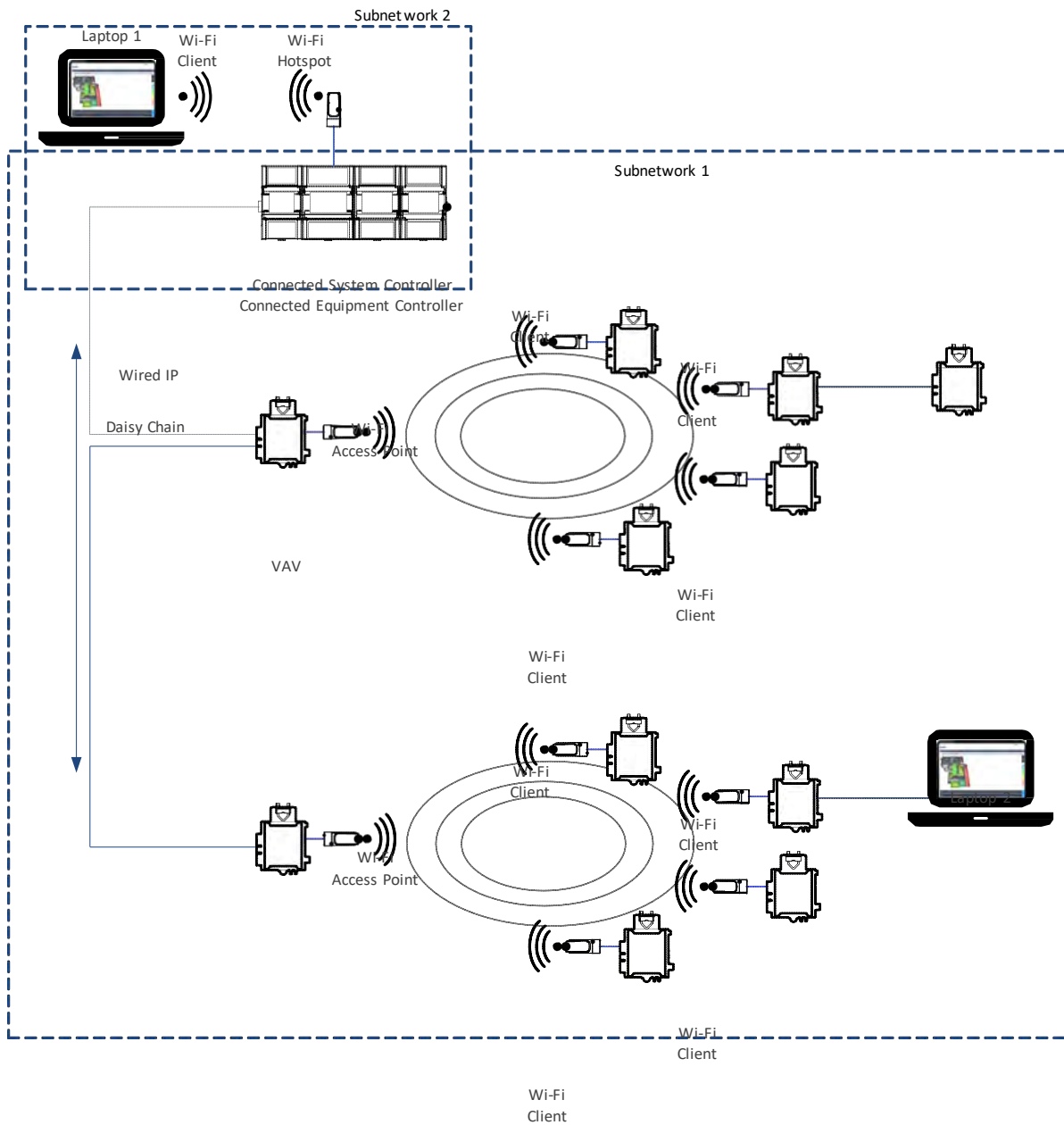

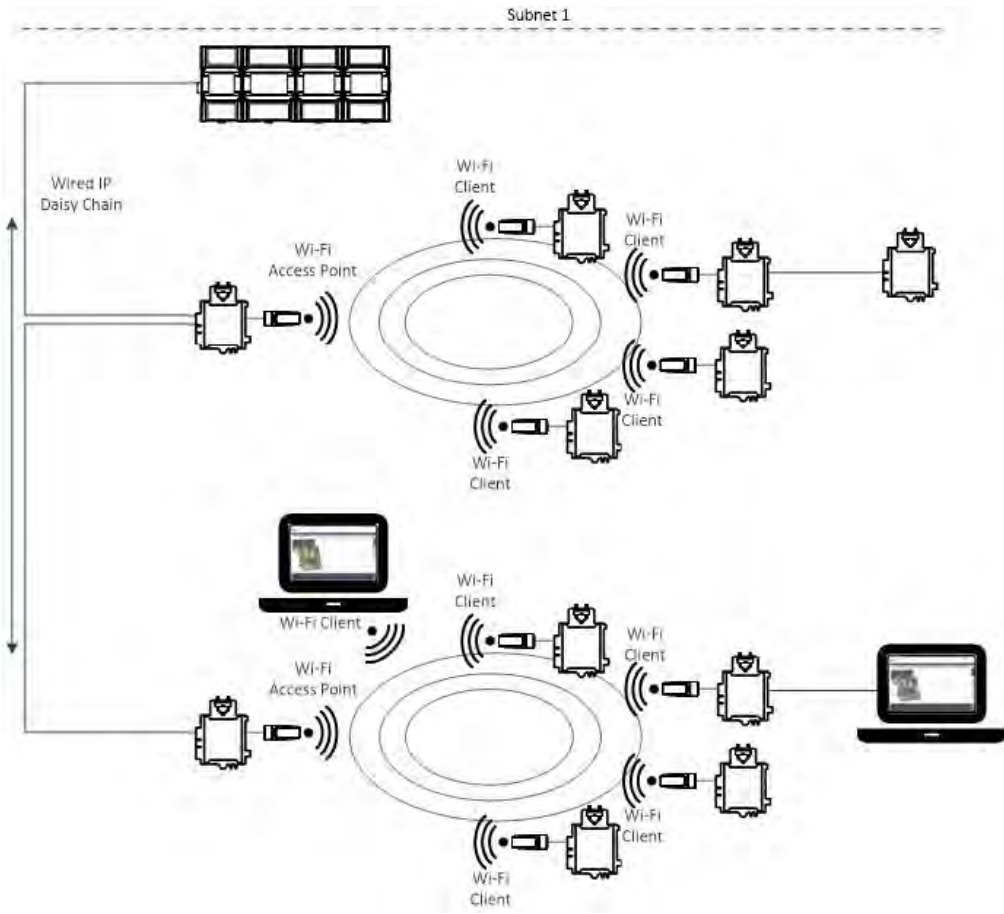

CHAPTER 6

FIRST TIME CONNECTION TO AN nLight ECLYPSE CONTROLLER

This paragraph is here to introduce the topics that will be discussed in the chapter. Following it should be a Topics paragraph.

Topics

[Connecting to the Controller](#)

[Ethernet Network Connection](#)

[Wi-Fi Network Connection](#)

[Configuring the Controller](#)

[Connecting to the Controller's Configuration Web Interface](#)

Connecting to the Controller

When connecting to the controller for the first time, the goal is to gain access to the controller so that you can configure it to work in its future network environment. To do so, you must connect the controller to form a network.

There are two networking methods to connect to a controller:

- Wired (Ethernet connection) with a PC.
- Wireless (when the nLight ECLYPSE Wi-Fi Adapter is connected to the controller) with a PC. See [Wi-Fi Network Connection](#).

Once you have connected the controller(s) to a network, configure the controller. See [Configuring the Controller](#).

Controller Identification

Controllers are uniquely identified on the network by their MAC address. This identifier is printed on a label located on the side of the controller and another is on the controller's box. Get a printed copy of the building's floor plan. During controller installation, peel the MAC address sticker off of the controller's box and put it on the floor plan where the controller has been installed.

This MAC address is used as part of the controller's factory-default Wi-Fi access point name and its hostname.

Figure 30: Finding the Controller's MAC Address

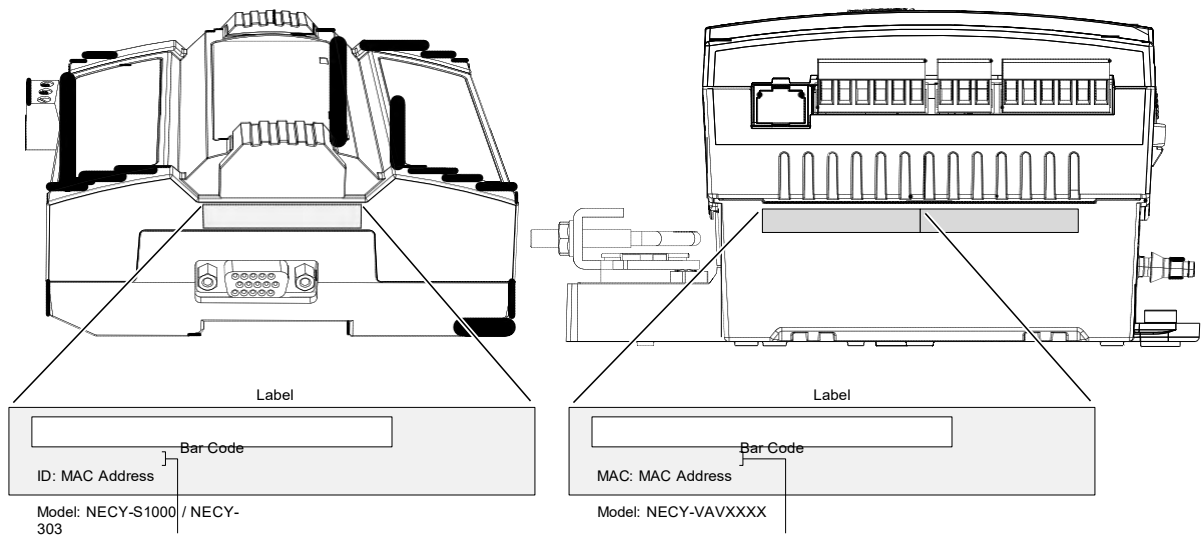

For example, for a MAC Address of : 76:a5:04:cd:4a:d1
 The factory-default name for the Wi-Fi access point is **nLight ECLYPSE-CD4AD1**
 The factory-default hostname is **nLight ECLYPSE-cd4ad1.local**

For example, for a MAC Address of : 76:a5:04:cd:4a:d1
 The factory-default name for the Wi-Fi access point is **nLight ECLYPSE-CD4AD1**
 The factory-default hostname is **nLight ECLYPSE-cd4ad1.local**

Depending on the controller model, the way the controller is connected to the network will change according to whether the controller is a Power over Ethernet (PoE) model or not.

- For non-PoE controller models, see [Network Connections for NECY Series Controllers](#).
- For the NECY-VAV-PoE controller, see [Network Connections for NECY-VAV- PoE Model Controllers](#).

See also [Connecting IP Devices to an IP Network](#) for network wiring considerations.

Network Connections for NECY Series Controllers

Connect the controller to the network as follows:

1. Connect your PC's network card to the controller's **PRI** Ethernet port using a Category 5e Ethernet cable.

If you are commissioning more than one controller, connect the controllers and PC to a network switch. Two or more controllers can be connected to the network by daisy-chaining them together by using Cat 5e network Cables to connect the **Ethernet Switch Sec**(ondary) connector of one controller to the **Ethernet Switch Pri**(mary) connector of the next controller.

Figure 31: nLight ECLYPSE Wired Network Connection: Cat 5e Cables with RJ-45 Connectors are used

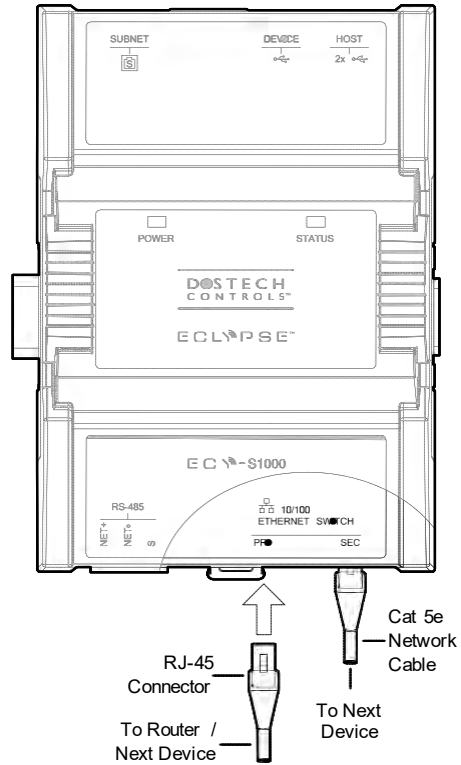

2. Connect power to the controller(s). See the controller's Hardware Installation Guide for how to do so.

Wi-Fi Network Connection

Once the nLight ECLYPSE Wi-Fi Adapter has been connected to a powered controller, a Wi-Fi hotspot becomes available that allows you to connect to the controller's configuration Web interface with your PC.

On your PC's wireless networks, look for an access point named nLight **ECLYPSE- XXYYZZ** where **XXYYZZ** are the last 6 hexadecimal characters of the controller's MAC address.

To find the controller's MAC address, see [Controller Identification](#).
The default password for the wireless network is: **ECLYPSE1234**

Either of the controller's two USB HOST ports can be used to connect the wireless adapter.

Figure 34: Connecting the Wireless Adapter to the Controller's USB HOST Port

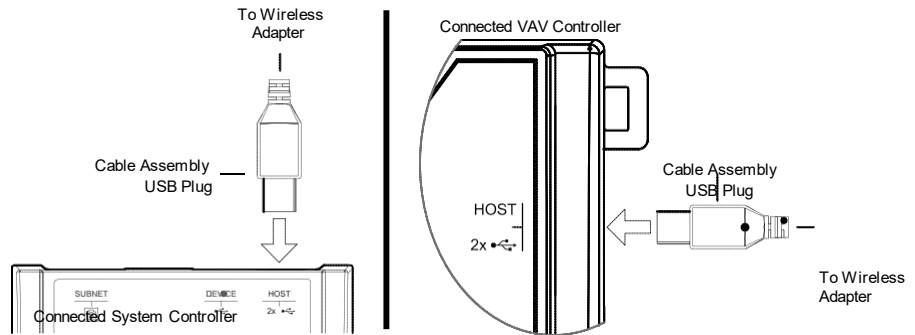

Configuring the Controller

Any of the following methods can be used to connect to the controller's interface in order to configure it:

- Using the controller's factory-default Hostname in the Web browser
- Using the controller's IP address in the Web browser

Using the Controller's Factory-default Hostname in the Web Browser

Controllers have a factory-default hostname that you can use instead of an IP address to connect to it¹. The hostname can be used in a Web browser's address bar. Then install The Bonjour service. The Bonjour service must be installed on your PC to allow your PC to discover controllers by their hostname.

If your PC is unable to resolve the controller's hostname, you must connect your PC to the controller through Ethernet or Wi-Fi so that your PC only sees the controller network. For example, in this case, your PC must be disconnected from all other networks such as a corporate network or the Internet. If necessary, temporarily disconnect your PC's network cable from its Ethernet port.

The controller's factory-default hostname is **ECLYPSE-xxxxxx.local** where **xxxxxx** is the last 6 characters of the MAC address printed on a sticker located on the side of the controller. See [Controller Identification](#).

For example, the sticker on the side of a controller shows that its MAC address is 76:a5:04:cd:4a:d1. Connect to the controller's Web interface as follows:

1. Open your Web browser.
2. In the Web browser's address bar, type **https://nLight ECLYPSE-cd4ad1.local** and click go.
3. Login to the controller. Then set the controller's configuration parameters in the controller's configuration Web interface. See [Connecting to the Controller's Configuration Web Interface](#).

The Hostname can be changed in the [System Settings](#).

Using the Controller's IP Address in the Web Browser

Connect to a controller through its IP address as follows:

1. Open your Web browser.
2. In the Web browser's address bar, type **https://192.168.0.1** (the controller's factory-default wireless hotspot IP address) and click go.
3. Login to the controller. Then set the controller's configuration parameters in the controller's configuration Web interface. See [Connecting to the Controller's Configuration Web Interface](#).

1. Not all smart phones/mobile devices have the Bonjour service installed and thus cannot use the hostname mechanism.

For a Wi-Fi network connection

For an Ethernet network connection

You must know the controller's current IP address (from the DHCP server for example).

1. Open your Web browser.
2. In the Web browser's address bar enter the controller's IP address and click go.
3. Login to the controller. Then set the controller's configuration parameters in the controller's configuration Web interface. See [Connecting to the Controller's Configuration Web Interface](#).

Connecting to the Controller's Configuration Web Interface

The nLight ECLYPSE Series Controller configuration can be made through the controller's configuration Web interface to set all the controller's configuration parameters including the controller's IP address according to your network planning.

At the first connection to an nLight ECLYPSE Controller you will be forced to change the password to a strong password for the admin account to protect access to the controller.

It is important to create new user accounts with strong passwords to protect the controller from unauthorized access. Remove the factory default admin account as this is a commonly known security breach (only the password for this user account needs to be compromised). See [User Management](#), [Securing an nLight ECLYPSE Controller](#), and [Supported RADIUS Server Architectures](#).

Next Steps

In Network Settings, configure the controller's network parameters so that they are compatible with your network. See [nLight ECLYPSE Web Interface](#).

CHAPTER 7

nLight ECLYPSE WEB INTERFACE

This chapter describes the nLight ECLYPSE controller's Web interface.

Topics

[Overview Network](#)

[Settings BACnet](#)

[Settings User](#)

[Management](#)

[Radius Server Settings](#)

[System Settings](#)

Overview

The nLight ECLYPSE controller has a web-based interface that allows you to view system status, configure the controller, update the controller's firmware, and access different applications associated to your projects.

Note that if you intend on enabling FIPS 140-2 mode, it should be done prior to configuring the controllers. See [FIPS 140-2 Mode](#).

Figure 41: nLight ECLYPSE Controller's Web Interface Welcome Home Page

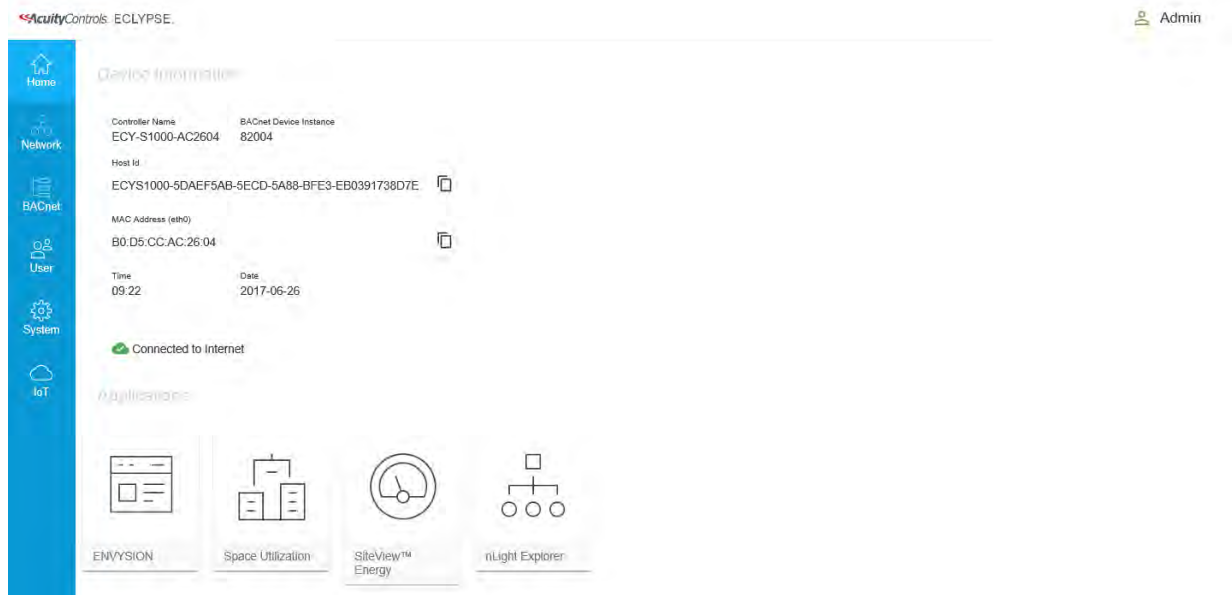

Configuration Menu

The sidebar contains the Configuration menus that allow you to view and set the controller's configuration settings including its IP address, Wi-Fi settings, and to update the controller's firmware. The menus may vary according to the associated device licenses and the user's access level. These configuration parameters are password protected.

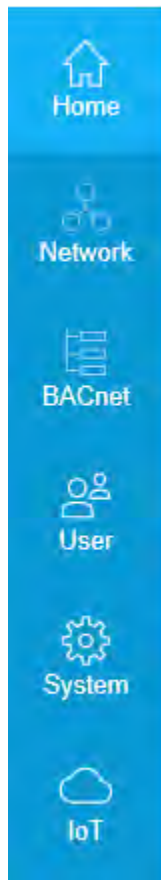

- *IPS Luminaires*
- *Home Page*
- *Network Settings*
- *BACnet Settings*
- *User Management*
- *System Settings*

HomePage

The main area of the home page consists of the following items:

Item	Description
Device Information	This section provides basic information on the device such as controller name, device instance, host ID, MAC address, time, and date.
	The Copy icon allows you to copy the Host Id and/or the MAC address of the device to that you can quickly paste elsewhere as needed.
Connected to Internet	This indicates whether the nLight ECLYPSE controller is connected to the Internet or not.

Item	Description	
Applications	To access different applications associated to your projects and controller license such as the following:	
	SiteView™ Energy	The energy metering edge application gives building owners real-time, actionable data about their facility's energy consumption and makes it easier to identify usage trends and savings
	nLight Explorer	An edge application that gives a general system overview and a look at the system health of connected nLight devices
	Space Utilization	The Space Utilization edge application allows building owners and property managers to analyze where occupants spend their time throughout the day, and make data-driven decisions for renovation, space planning and other expansions
	ENVYISION	The responsive, web-based design and visualization interface that delivers actionable, graphical data

User Profile and Login Credentials

Click the profile box to change your password and logout.

At the first connection to an nLight ECLYPSE Controller you will be forced to change the password to a strong password for the *admin* account to protect access to the controller. It is important to create new user accounts with strong passwords to protect the controller from unauthorized access.

See *User Management*, *Securing an nLight ECLYPSE Controller*, and *Supported RADIUS Server Architectures*.

To change your password

1. To change your password, click the profile icon and select **Change Password**.

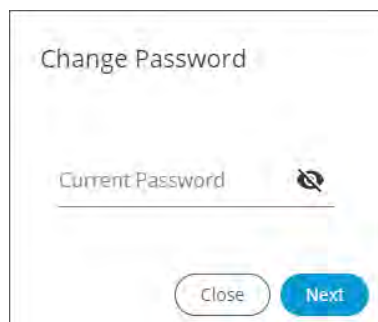

2. Enter your current password and click **Next**.

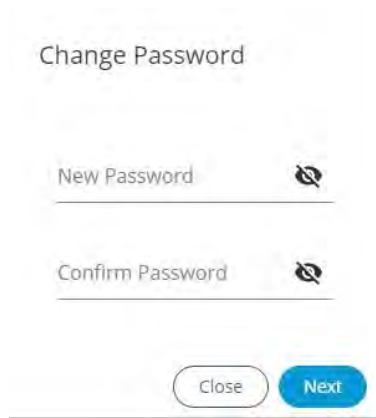

Change Password

New Password

Confirm Password

Close Next

The image shows a 'Change Password' dialog box. It has a title 'Change Password' at the top. Below the title are two password input fields. The first field is labeled 'New Password' and the second is labeled 'Confirm Password'. Both fields have a small eye icon to the right of the input area, indicating a toggle for password visibility. At the bottom of the dialog, there are two buttons: a white button with a grey border labeled 'Close' and a blue button labeled 'Next'.

3. Enter the new password twice to confirm and click **Next**. Your password is changed.

NetworkSettings

The **Network** menu is used to configure the nLight ECLYPSE controller's network interface and set up the wired and wireless network configuration parameters. The available menus are:

- Ethernet
- Wireless
- Diagnostic

Ethernet

The Ethernet screen is used for any wired IP connections that are made through either one of the controller's **Ethernet Switch Pri**(mary) connector or **Ethernet Switch Sec**(ondary) connector. See [Figure 31](#) and [Figure 32](#). The Wired IP parameters can be auto-configured when the connected network has a working DHCP server. The alternative is to manually configure the controller's IP parameters.

The screenshot displays the 'Ethernet' configuration page. At the top, there are three tabs: 'Ethernet', 'Wireless', and 'Diagnostic'. The 'Ethernet' tab is selected. Below the tabs, the title 'Ethernet Primary' is visible. A checkbox for 'DHCP' is unchecked. The following fields are filled with values: IP Address (10.59.83.167), Subnet Mask (255.255.252.0), Gateway (10.59.80.1), Primary DNS (10.59.68.5), and Secondary DNS (10.207.65.120). At the bottom left, there is a circular refresh icon, and at the bottom right, there is a blue 'Apply' button.

Option	DHCP Client: Enabled	DHCP Client: Disabled
DHCP	If the controller is connected to a network that has an active DHCP server, enabling this option will automatically configure the Wired IP connection parameters. The Wired IP parameters shown below are read only (presented for information purposes only).	If you want to manually configure the controller's network settings (to have a fixed IP address for example) or in the case where the network does not have a DHCP server, disable this option. In this case, you must set the Wired IP connection parameters shown below to establish network connectivity. See also DHCP versus Manual Network Settings
IP Address	This is the IP Address provided by the network's DHCP server.	Set the IP address for this network device. See IPv4 Communication Fundamentals Ensure that this address is unique from all other device on the LAN including any used for a hot spot's IP addressing.
Subnet Mask	This is the subnet mask provided by the network's DHCP server.	Set the connected network's subnetwork mask. See About the Subnetwork Mask
Gateway	This is the gateway IP Address provided by the network's DHCP server.	The IP address of the default gateway to other networks. This is usually the IP address of the connected network router. See Default Gateway
Primary DNS Secondary DNS	This is the primary and secondary DNS IP Address provided by the network's DHCP server.	The connected network's primary and secondary IP address of the DNS servers. See Domain Name System (DNS)

When making changes to the network settings, click **Apply** to apply and save the changes. You can click refresh to refresh the information in the screen.

Wireless Configuration

This configuration interface is for any nLight ECLYPSE Wi-Fi Adapter connected to the **HOST** connector.





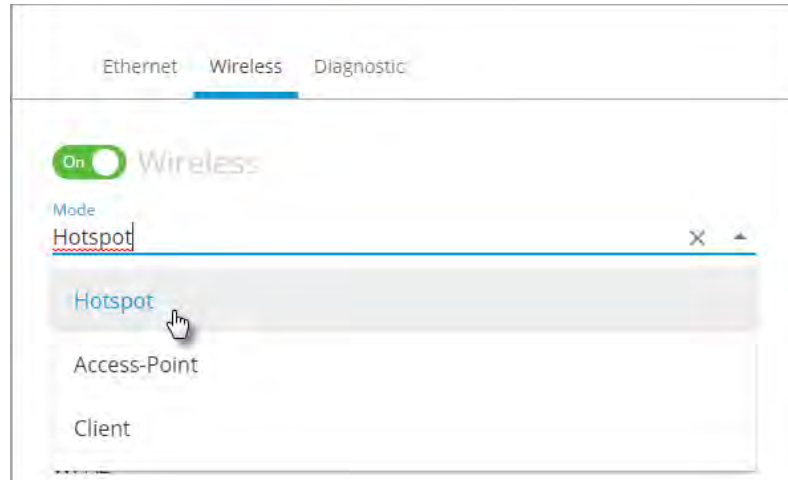

A hotspot creates a subnetwork. As a result, any connected BACnet device will not be able to discover BACnet devices on any other LAN subnetwork.

Figure 42: The Wi-Fi network operating modes: Hotspot, Access-Point, or Client.



The Wireless connection parameters can be set as follows.

Item	Description
On / Off 	This enables/disables the controller's wireless features.
Wireless Mode	Select the Wi-Fi network operating mode: Hotspot, Access-Point, or Client. <ul style="list-style-type: none"> • Hotspot: This creates a Wi-Fi hot spot with a router. See <i>Setting up a Wi-Fi Hotspot Wireless Network</i> for how to configure this mode. • Access-Point: This creates a Wi-Fi access point. See <i>Setting up a Wi-Fi Access Point Wireless Network</i> for how to configure this mode. • Client: this connects the controller as a client of a Wi-Fi access point. See <i>Setting up a Wi-Fi Client Wireless Network</i> for how to configure this mode. See also <i>nLight ECLYPSE Wi-Fi Adapter Connection Modes</i> .
Network Name	The network name is the Service Set Identification (SSID) for a Wi-Fi hotspot. This parameter is case sensitive. When this controller's active mode is configured as a: <ul style="list-style-type: none"> • For Hotspot: set a descriptive network name that other wireless clients will use to find this hotspot. • For Client: select an available hotspot from the lists of access point connections that are within range. Click the Wi-fi icon  to select an available Wi-Fi network from the list of access points that are within range.

Item	Description
Encryption	Set the encryption method to be used by the Wi-Fi network: <ul style="list-style-type: none"> • Open: this option should be avoided as it does not provide any wireless security which allows any wireless client to access the LAN. • WPA2: select the Wi-Fi Protected Access II option to secure the Wi-Fi network with a password.
Password	When encryption is used, set the password to access the Wi-Fi network as a client or the password other clients will use to access this hotspot. Passwords should be a long series of random alphanumeric characters and symbols that are hard to guess. This parameter is case sensitive.
 	Click to show or hide the password.
IP Address	This is the IP address for a Hotspot (or gateway address that wireless clients will connect to). Ensure that this address is: <ul style="list-style-type: none"> • Not in the range of IP address set by First Address and Last Address. • Not the same as the IP address set under IP Configuration for the wired network.
Subnet Mask	The hotspot's subnetwork mask. See About the Subnetwork Mask .
First Address Last Address	This defines the range of IP addresses to be made available for Hotspot clients to use. The narrower the range, the fewer hotspot clients will be able to connect due to the lack of available IP addresses. For example, a range where First Address = 192.168.0.22 and Last Address = 192.168.0.26 will allow a maximum of 5 clients to connect to the hotspot on a first-to-connect basis.
Advanced	When a Hotspot or Access-point is configured, this sets the channel width and number the hot spot is to use. The wireless mode can also be set. See below.
ChannelNumber	This sets the center frequency of the transmission. If there are other Wi-Fi networks nearby, configure each Wi-Fi network to use different channel numbers to reduce interference and network drop-outs. Note: The range of available channels may vary from country to country.
Wi-FiMode	This sets the wireless mode (wireless G or wireless N). Wireless N mode is backwards compatible with wireless G and B. Wireless G mode is backwards compatible with wireless B.
SSIDHidden	For a Client hot spot, hide or show the Service Set IDentification (SSID).

Item	Description
	Click to refresh the information in the list.
Apply	Click Apply to apply and save the changes

Network Diagnostics

The **Diagnostic** menu provides a number of tools to diagnose network connectivity issues between controllers.

- **Wi-Fi Monitor:** shows the current performance of a Wi-Fi connection with another controller.
- **Ping Monitor:** shows the round trip time it takes for a ping packet to go to an IP address and come back.

Figure 43: Network Diagnostics: Wi-Fi Monitor

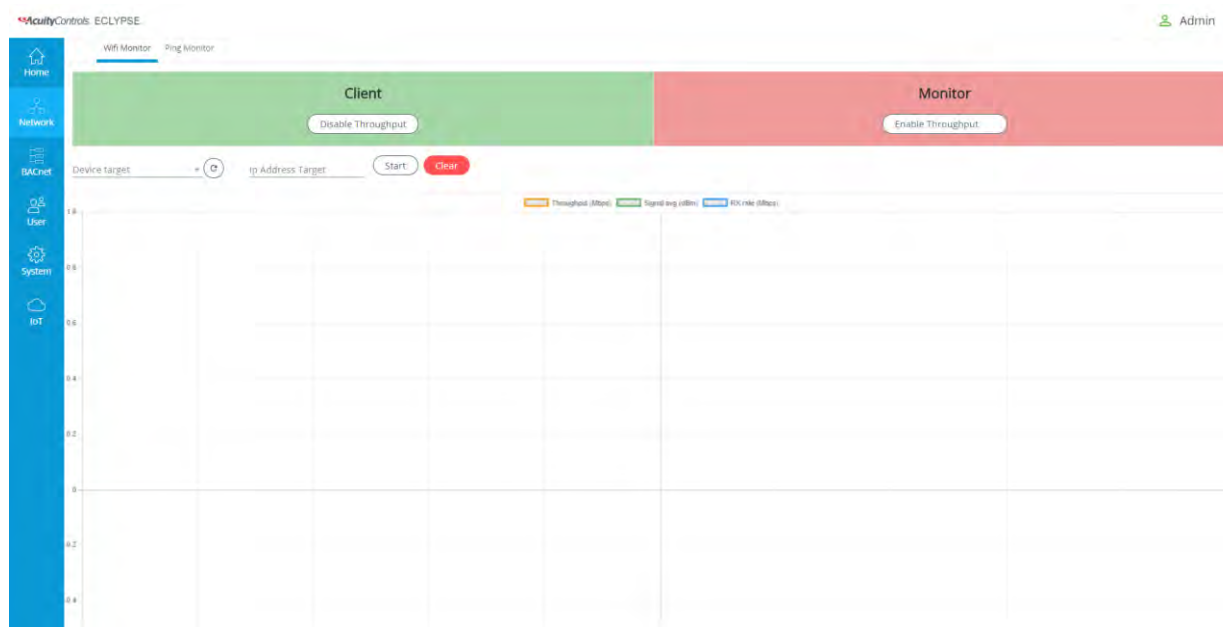

Item	Description
DisableThroughput	This disables the Wi-Fi Monitoring throughput client service. For Wi-Fi monitor to work, this must be started.
EnableThroughput	This activates the Wi-Fi Monitoring throughput client service. For Wi-Fi monitor to work, this must be started.

Item	Description
Device Target	Select the corresponding controller's MAC address in the Device Target list.
Ip Address Target	Enter the corresponding controller's IP address for its Wi-Fi interface in Ip Address Target .
	Click to refresh the information in the Device Target list.
Start	Starts graphing the monitored data.
Clear	Clears the graph.
Throughput (Mbps)	The transmit datarate to the target.
Signal avg (dBm)	The current average receive signal strength. Note: Signal strength is measured in negative units where the stronger the signal, the closer it is to zero. A weaker signal strength will have a more negative number. For example, a receive signal strength of -35 dBm is much stronger than a receive signal strength of -70 dBm.
RX rate (Mbps)	The receive datarate from the target.

Figure 44: Network Diagnostics - Ping Monitor



Item	Description
Ip AddressTarget	Enter the corresponding controller's IP address for its Wi-Fi interface in Ip AddressTarget .
Start	Starts graphing the monitored data.
Clear	Clears the graph.

BACnet Settings

This is where the BACnet interface parameters are set.

General

This sets the controller's BACnet network parameters.

Figure 45: General BACnet Settings

The screenshot shows a web interface for configuring BACnet settings. At the top, there are four tabs: 'General', 'Routing', 'Network IP Ports', and 'Network MS/TP Ports'. The 'General' tab is selected and highlighted with a blue underline. Below the tabs, the title 'General' is displayed. The configuration fields are as follows:

- Controller Name: ECY-S1000-37174C44
- Device ID: 111
- Location: (empty)
- Description: (empty)
- APDU Timeout (ms): 6000
- APDU Segment Timeout (ms): 5000
- APDU Retries: 3

At the bottom of the form, there is a circular refresh icon on the left and a blue 'Apply' button on the right.

Item	Description
Controller Name	Set a descriptive name by which this controller will be known to other BACnet objects.
Device ID	Each controller on a BACnet intra-network (the entire BACnet BAS network) must have a unique Device ID. Refer to the NetworkGuide for more information.
Location	The current controller's physical location. This is exposed on the BACnet network as a device object property.
Description	A description of the controller's function. This is exposed on the BACnet network as a device object property.
APDU Timeout (ms)	The maximum amount of time the controller will wait for an acknowledgment response following a confirmed request sent to a BACnet device before re-sending the request again or moving onto the next request. This property is exposed on the BACnet network as a device object property.

Item	Description
APDU Segment Time-out(ms)	The maximum amount of time the controller will wait for an acknowledgment response following a confirmed segmented request sent to a BACnet device before re-sending the segmented request again or moving onto the next request. This property is exposed on the BACnet network as a device object property.
APDU Retries	This sets the number of times to retry a confirmed request when no acknowledgment response has been received. This property is exposed on the BACnet network as a device object property.
	Click to refresh the information in the list.
Apply	Click Apply to apply and save the changes

Routing

This enables the routing of BACnet packets between BACnet MS/TP controllers connected to the nLight ECLYPSE Connected System Controller's RS-485 port and BACnet/IP controllers connected to the nLight ECLYPSE Connected System Controller's Ethernet Switch ports. For example, routing must be enabled for EC-Net to discover the BACnet MS/TP controllers connected to the nLight ECLYPSE Connected System Controller's RS-485 port.

Figure 46: BACnet Routing Configuration

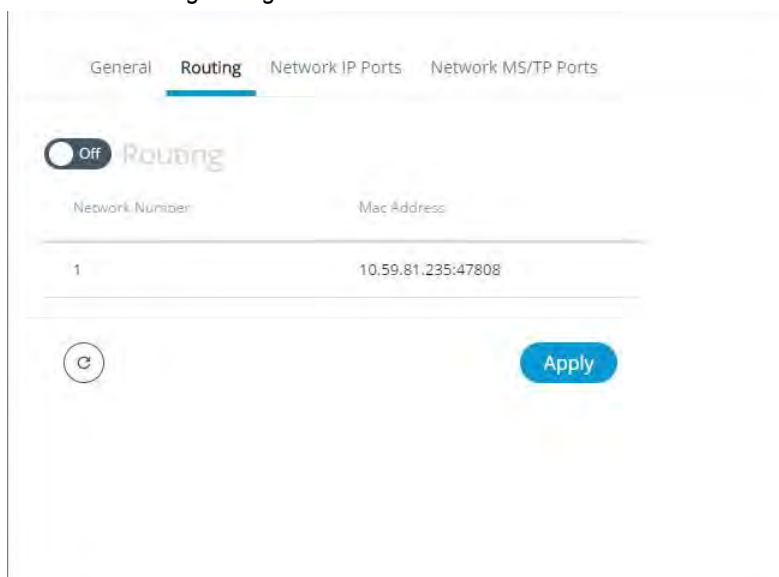

Item	Description
	This enables/disables the routing of BACnet packets between BACnet MS/TP controllers connected to the nLight ECLYPSE Connected System Controller's RS-485 port and BACnet/IP controllers connected to the nLight ECLYPSE Connected System Controller's Ethernet Switch ports.

Item	Description
Network Number	A network number identifies a LAN for routing purposes. All controllers with the same network number are members of the same logical BACnet network. See <i>Device Addressing</i> .
Mac Address	The device Mac address.
	Click to refresh the information in the list.
Apply	Click Apply to apply and save the changes.

Network IP Ports

This sets the IP network configuration parameters (on-board port) as well as the BACnet Broadcast Management Device (BBMD) and Foreign Device for intranetwork connectivity.

Figure 47: BACnet IP Configuration - Network IP Ports

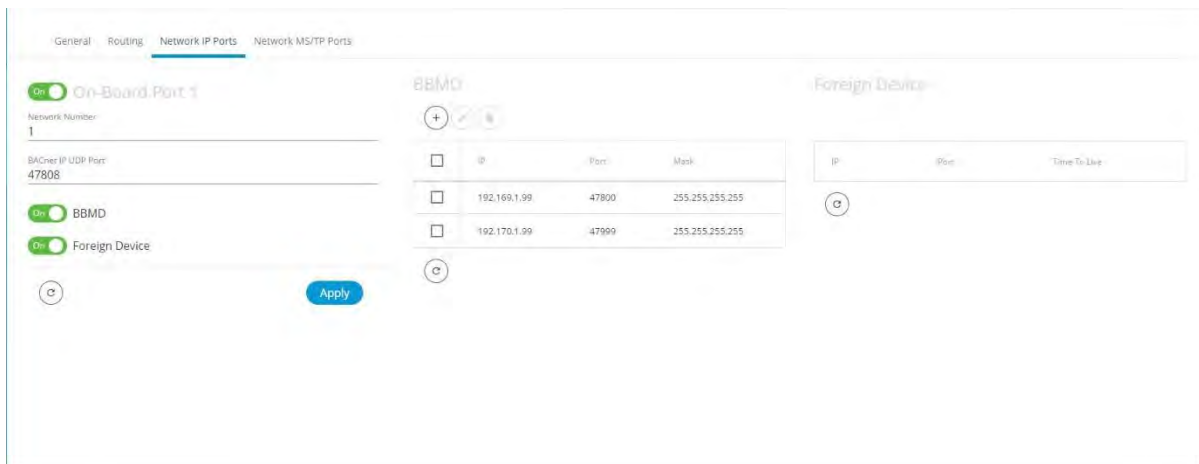

On-BoardPort

Item	Description
On/Off 	This enables/disables the routing of BACnet packets between BACnet MS/TP controllers connected to the nLight ECLYPSE Connected System Controller's RS-485 port and BACnet/IP controllers connected to the nLight ECLYPSE Connected System Controller's Ethernet Switch ports.
Network Number	A network number identifies a LAN for routing purposes. All controllers with the same network number are members of the same logical BACnet network. See Device Addressing .
BACnet IP UDP Port	This is the standard BACnet/IP port number (UDP 47808) used by BACnet devices to communicate.







Item	Description
Enable BBMD	BBMD allows broadcast message to pass through a router. See BBMD Settings . To enable this feature, set Enable BBMD on only one device on each subnet.
Enable Foreign Devices	Foreign Device Registration allows a BACnet/IP device to send broadcast messages to a device with BBMD enabled. See Foreign Device Settings . To enable this feature, set Enable Foreign Devices on only one device on each subnet.
	Click to refresh the information in the list.
Apply	Click Apply to apply and save the changes

BBMD Settings

BACnet/IP devices send broadcast discovery messages such as “Who-Is” as a means to discover other BACnet devices on the network. However, when there are two or more BACnet/IP subnetworks, broadcast messages do not pass through network routers that separate these subnetworks.

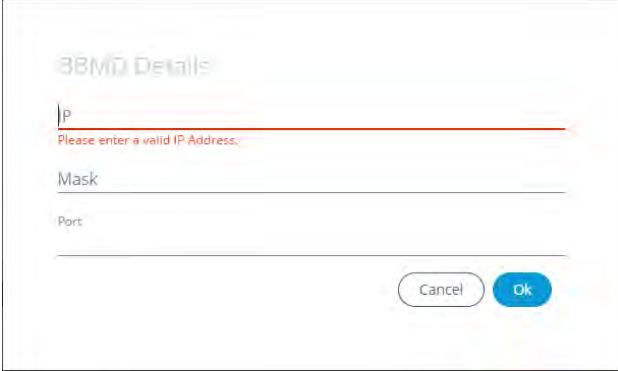
BBMD allows broadcast message to pass through a router: on each subnet, a single device has BBMD enabled. Each BBMD device ensures BACnet/IP connectivity between subnets by forwarding broadcast messages found on its subnetwork to each other, and then onto the local subnetwork as a broadcast message.

In the BBMD table, add the BBMD-enabled controllers located on other sub-networks.

Item	Description
	<p>Add another subnetwork's BBMD to this controller's a Broadcast Distribution Table. To add a BBMD:</p> <ol style="list-style-type: none"> Click . <p><i>Figure 48: Adding a BBMD</i></p>  <ol style="list-style-type: none"> In the IP field, enter IP address of the BBMD located on the other subnetwork. In the Mask field, enter the subnetwork mask for the other subnetwork. In the Port field, enter the port number for the BACnet service of the BBMD located on the other subnetwork. Click OK.
	<p>Edit a BBMD's information. This icon is displayed only when one or more BBMD is selected <input checked="" type="checkbox"/> from the list.</p>
	<p>Remove a BBMD from this controller's Broadcast Distribution Table. This icon is displayed only when one or more BBMD is selected <input checked="" type="checkbox"/> from the list.</p>
	<p>Click to refresh the information in the list.</p>

Foreign Device Settings

Some BACnet/IP devices also support a feature called Foreign Device Registration (FDR). FDR allows a BACnet/IP device to send broadcast messages to a device with BBMD enabled. The BBMD-enabled device will then forward these broadcast messages to all other BBMDs and onto all other FDR devices. If a subnet has only FDR supported devices then it does not need a

local BBMD. These devices can register directly with a BBMD on another sub-network.

Item	Description
Ip	The IP address of a controller (foreign device) located on another subnetwork.
Mask	The port number for the BACnet service of the controller located on the other subnetwork.
Port	This is the delay after which the foreign device is forgotten.
	Click to refresh the information in the list.

Network MS/TP Ports

Some controller models support up to three RS-485 ports. Some controllers only support Modbus RTU on its RS-485 port. See the controller’s datasheet for more information.

BACnet MS/TP and Modbus RTU communications are made by connecting directly to separate RS-485 ports. **On-board RS-485 Port** is the controller’s onboard RS-485 port. When an NECY-RS485 expansion module is attached to the controller, **NECY-RS485 Module Port 1** is port #1 and **NECY-RS485 Module Port 2** is port #2 on that module. The following network configuration parameters are for an RS-485 port that is used to communicate with BACnet MS/TP controllers.

Figure 49: Network MS/TP Ports

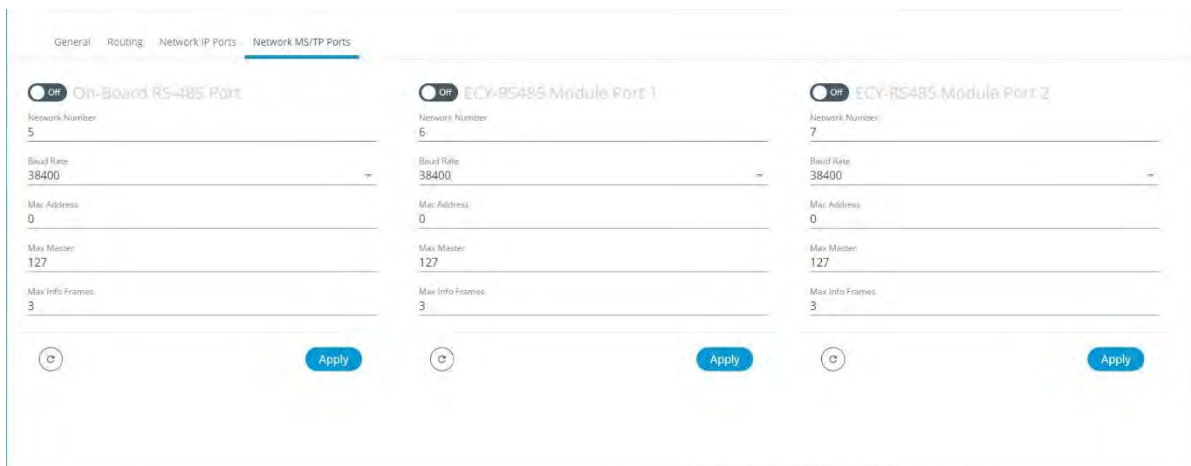

Item	Description
On/Off 	This enables/disables the controller’s BACnet MS/TP connection. If the controller has been configured to use Modbus RTU, this option cannot be enabled. First disable Modbus RTU in EC-gfx Program.

Item	Description
Network Number	A network number identifies a LAN for routing purposes. All controllers with the same network number are members of the same logical BACnet network. See Device Addressing .
Baud Rate	The recommended baud rate setting is 38 400. See Baud Rate .
Mac Address	The NECY series controller's MAC Address on the BACnet MS/TP Data Bus.
Max Master	When commissioning a BACnet MS/TP Data Bus, it is useful to start with the Max Master set to 127 so as to be able to discover all devices connected to the data bus. Then, once all devices have been discovered and the MAC Addressing is finalized by eliminating any gaps in the address range, set the Max Master (the highest MAC Address) to the highest Master device's MAC Address number to optimize the efficiency of the data bus. See Setting the Max Master and Max Info Frames .
Max Info Frames	For the NECY series controller, this should be set to 20. See Setting the Max Master and Max Info Frames .
	Click to refresh the information in the list.
Apply	Click Apply to apply and save the changes

User Management

User management is the control of who can access the controller by enforcing the authentication credentials users need to access the controller. User management can either be locally managed or remotely managed. If there is more than one nLight ECLYPSE controller on the network, it is best to centralize access management .

User management can also set the welcome page a user will land on when they connect to the controller.

Local Configuration

User access to this controller and to other controllers that are using this controller as their RADIUS server are managed by adding them to the **Local User Management** shown below.

Figure 50: Local Configuration_ User Management

Local Configuration Password Policy Radius Server Settings				
<input type="checkbox"/>	Username	Welcome Page	Password Reset	Roles
<input type="checkbox"/>	admin		false	Admin
<input type="checkbox"/>	gfx		true	Rest
<input type="checkbox"/>	toto		false	Admin
<input type="checkbox"/>	hjj		false	Operator

Item	Description
Add	Add a new user to user management. See <i>Adding a User</i> . These users will have login access to the controller. It is important to create new user accounts with strong passwords to protect the controller from unauthorized access. See Securing an nLight ECLYPSE Controller .

Item	Description
Edit	Edit a user's information. When editing user information, the user password is not shown therefore the field appears empty. You can leave the password as is or assign a new one
Remove	<p>Remove a user from user management. Remove the factory default admin account as this is a commonly known security breach (only the password for this user account needs to be compromised). Proceed as follows.</p> <ol style="list-style-type: none"> 1. Create a new user account with administrative rights for yourself. 2. Logout of the admin account and then login to the user account you have created. 3. Remove the factory default admin account.

Adding a User



Adding a user creates a user profile that allows a person to login to the controller with a username / password combination and to have access to certain controller software interfaces. When this controller is used as a RADIUS server by other controllers, users connecting to those controllers will have access to those controllers as defined by their user profile.

User management can also set the welcome page a user will land on when they connect to the controller with the **Welcome Page** setting.

1. Click to add a new user or to edit an existing user. The **Local User Details** window is displayed.

Figure 51: Adding a User

2. Enter the information as shown below:

Item	Description
Username	The user's login credential.
Password	The user's password credential.
 	Show/Hide the user's password credential.
User must change password at next login	Select to force user to change their password at the next login.

3. Click **Next**. The **Roles** options are displayed.

Local User Details

Roles

Admin Operator Viewer Rest

Previous Cancel

4. Select the access levels the user will be able to use. Set one or more options according to the user's role:

Admin	Allows user access to the ENVYSION studio and viewer. The user can also view and modify all configuration interface parameters and program the controller with EC-gfxProgram.
Operator	Allows user access to the ENVYSION interface in viewing mode as well as gives partial access to the nLight ECLYPSE Web Configuration Interface. Certain configuration interface screens are unavailable such as User Management, Viewer Information, etc.
Viewer	Allows user access to the ENVYSION interface in Viewing mode. The user is not allowed to access the nLight ECLYPSE Web Configuration Interface.
Rest	Allows a user to program the controller with EC-gfxProgram. This user does not have access to the nLight ECLYPSE Web Configuration Interface or ENVYSION.

5. Click **Next**. The **Welcome Page** screen is displayed where you can set the landing page that will be displayed to individual users when they login to the controller.

Local User Details

Welcome Page

Welcome Page URL

Previous Cancel Ok

6. Enter the URL of the web page found after the controllers' IP address or hostname. This should be copied from your Web browser's address bar when you have navigated to the target page.

For example, the address for the user default web page is **HOSTNAME/nLightECLYPSE/envysion/viewer.html?proj=ENVYSION_PROJECT_NAME** or

192.168.0.1/config/bacnet.html, remove the hostname or IP Address so that the URL becomes /config/bacnet.html. See *User Management*.

7. Click **OK**, and because authentication is required, enter your username and password.

Password Policy

The password policy sets the minimum requirements for a valid password to help prevent common password cracking techniques. By requiring long passwords with a well-rounded composition of elements (uppercase and lowercase letters, numbers, and symbols) makes the password harder to guess and makes a brute force attack less effective.

Select the **Password Policy** tab to display the password options:

Item	Description
Password length (>8)	The minimum password length. See also <i>FIPS 140-2 Mode</i> for password settings.
Uppercase letters	The minimum number of uppercase letters (A to Z) required to compose the password.
Lowercase letters	The minimum number of lowercase letters (a to z) required to compose the password.
Numbers	The minimum number of numbers (0 to 9) required to compose the password.

Item	Description
Symbols	The minimum number of symbols (for example, =, +, &, ^, \$, etc.) required to compose the password.
	Click to refresh the information in the list.
Apply	Click Apply to apply and save the changes

System Settings

CHAPTER 8

CONFIGURING THE nLight ECLYPSE WI-FI ADAPTER WIRELESS NETWORKS

nLight ECLYPSE Wi-Fi Adapter supports a number of wireless network connection modes. This chapter describes how to configure a controller's wireless network. See also [nLight ECLYPSE Wi-Fi Adapter Connection Modes](#).

Topics

[Setting up a Wi-Fi Client Wireless Network](#)
[Setting up a Wi-Fi Access Point Wireless Network](#)
[Setting up a Wi-Fi Hotspot Wireless Network](#)

Setting up a Wi-Fi Client Wireless Network

This connects the controller as a client of a Wi-Fi access point. See [Wi-Fi Client Connection Mode](#) for more information.

Figure 66: Client Wireless Network Settings

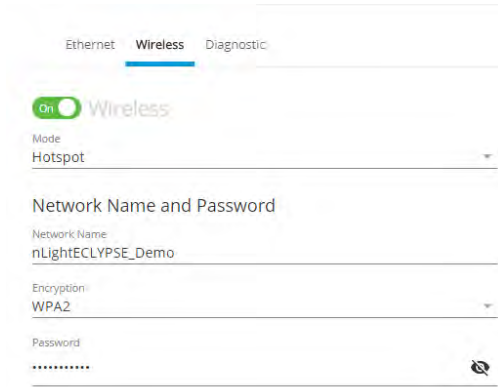

Configure the controller's nLight ECLYPSE Wi-Fi adapter mode as a Wi-Fi client as follows.

1. Set **On**.
2. Set the **Mode** to **Client**.
3. Click for  the controller to search for available access points that are within range. The access points are listed on the right.

Figure 67: List of Available Access Points to Pair With



4. Select an access point to pair with from the access point list. The **Encryption** mode is provided by the access point.
5. Set the access point's authentication password in
6. **Password**. This password is set in the access point's (or wireless router's) configuration.
7. Click **Apply**.

Setting up a Wi-Fi Access Point Wireless Network

This turns the controller into a Wi-Fi access point that other wireless clients can use to have network access. This access point operates off of the same subnetwork and has the same IP connectivity that the controller has with its wired network connection. For example, if the controller's wired connection is to a network that has an active DHCP server, access point clients can also use this DHCP server to automatically configure their IP connection parameters. See [Wi-Fi Access Point](#) for more information.

Figure 68: Access Point Wireless Network Settings

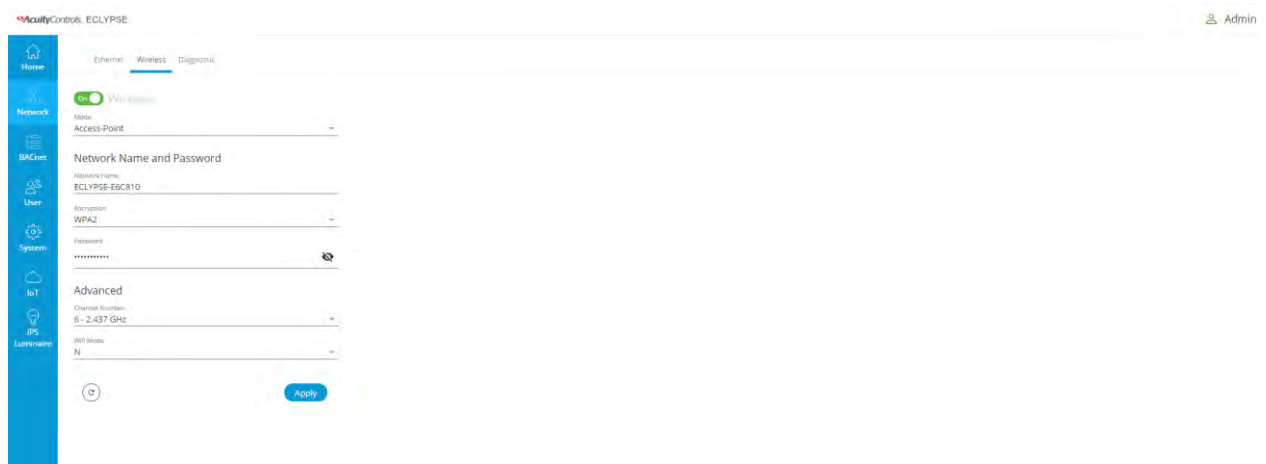

Configure the controller's nLight ECLYPSE Wi-Fi adapter mode as a Wi-Fi access point as follows.

1. Under **Wireless Configuration**, set **Enabled**.
2. Set the **Active mode** to **Hotspot/AP**.
3. Set the name for this access point by which wireless clients will identify it in **Network Name**.
4. Set the encryption mode to be used by this access point in **Encryption**:
 - **None: this option should be avoided** as it does not provide any wireless security which allows any wireless client to access the LAN.
 - **WPA2**: select the Wi-Fi Protected Access II option to secure the Wi-Fi network with a password.
 - **WPA2 Enterprise**: Use this option if you are connecting to an enterprise network that has a working RADIUS authentication server. This RADIUS server provides user authentication.
5. Set the access point's authentication password in **Password**. This is the password wireless clients will need to know in order to connect to this access point.
6. Under **Hotspot Configuration**, disable **Enabled**.

7. Under **Advanced**, set the **Channel Width**, **Channel Number**, and **Wi-Fi Mode**. See [BACnet Settings](#) for an explanation of these parameters.
8. Click **Apply**.

Setting up a Wi-Fi Hotspot Wireless Network

This turns the controller into a Wi-Fi hotspot with a router. This puts the hotspot into a separate subnet with a DHCP server to provide IP addresses to any connected device. See [Wi-Fi Hotspot](#) for more information.

Wide area network (WAN) connectivity is through the wired connection. See [Network Address Translation / Firewall](#). Though BACnet/IP uses IP protocol to communicate, this hotspot acts as an IP router; it does not forward broadcast messages which are important in BACnet to identify services that are available within the BACnet internetwork. See [BACnet/IP Broadcast Management Device Service \(BBMD\)](#).

Figure 69: Hotspot Wireless Network Settings

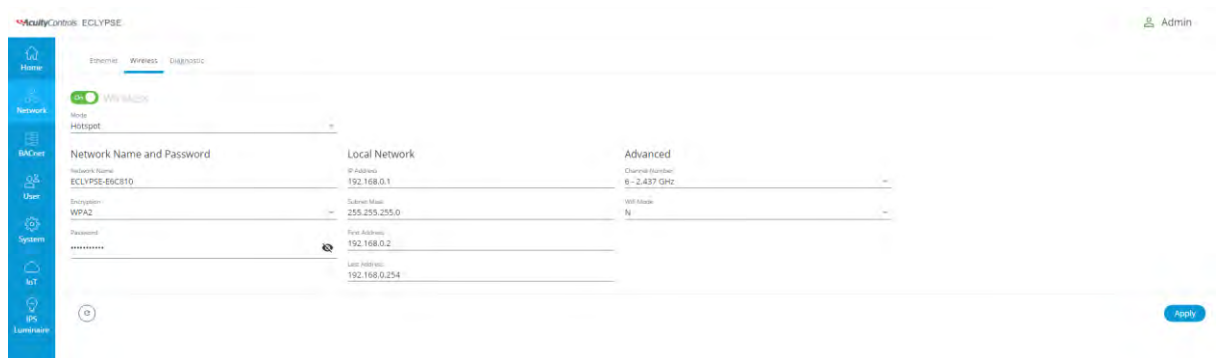

Configure the controller's nLight ECLYPSE Wi-Fi adapter mode as a Wi-Fi hotspot as follows.

1. Under **Wireless Configuration**, set **Enabled**.
2. Set the **Active mode** to **Hotspot/AP**.
3. Set the name for this access point by which wireless clients will identify it in **Network Name**.
4. Set the encryption mode to be used by this hotspot in **Encryption**:
 - **None: this option should be avoided** as it does not provide any wireless security which allows any wireless client to access the LAN.
 - **WPA2**: select the Wi-Fi Protected Access II option to secure the Wi-Fi network with a password.
 - **WPA2 Enterprise**: Use this option if you are connecting to an enterprise network that has a working RADIUS authentication server. This RADIUS server provides user authentication.
5. Set the hotspot's authentication password in **Password**. This is the password wireless clients will need to know in order to connect to this hotspot.
6. Under **Hotspot Configuration**, set **Enabled**.

7. Set the hotspot's IP address that wireless clients will connect to in **Ip Address**. Ensure that this address is:
 - Not in the range of IP address set by **First Address** and **Last Address**.
 - Not the same as the **IP address** set under IP Configuration for the wired network.
8. Set the hotspot's subnet mask in **Subnet Mask**. See [About the Subnet-work Mask](#).
9. Set the hotspot's addressing range in **First Address** and **Last Address**. This defines the range of IP addresses to be made available for hotspot clients to use. The narrower the range, the fewer hotspot clients will be able to connect due to the lack of available IP addresses. For example, a range where First Address = 192.168.0.22 and Last Address = 192.168.0.26 will allow a maximum of 5 clients to connect to the hotspot on a first-to-connect basis.
10. Under **Advanced**, set the **Channel Width**, **Channel Number**, and **Wi-Fi Mode**. See [BACnet Settings](#) for an explanation of these parameters.
11. Click **Apply**.

CHAPTER 9

SECURING AN nLight ECLYPSE CONTROLLER

This chapter describes how to harden an nLight ECLYPSE controller from unauthorized access and use.

Topics

[Introduction](#)

[Passwords](#)

[Account Management and Permissions](#)

[HTTPS Certificates](#)

[Additional Measures](#)

[External Factors](#)

Introduction

This chapter describes how to implement best security practices for nLight ECLYPSE controllers. Security is built up layer upon layer to make the system more resistant to attacks. This involves taking simple but effective steps to implement built-in security features.

Passwords

A username / password combination (or credentials) authenticates a user's access rights to a controller. If an attacker gains access to a user's password, the attacker has access to carry out any action on the controller that is allowed by that user's permissions.

Change the Default Platform Credentials

At the first connection to an nLight ECLYPSE Controller you will be forced to change the password to a strong password for the admin account to protect access to the controller.

It is important to create new user accounts with strong passwords to protect the controller from unauthorized access. Remove the factory default admin account as this is a commonly known security breach (only the password for this user account needs to be compromised). The username / password can be changed in [User Management](#) and see also [Supported RADIUS Server Architectures](#).

Use Strong Passwords

Passwords should be hard to guess. Avoid birth dates and common keyboard key sequences. A password should be composed of a random combination of 8 or more uppercase and lowercase letters, numbers, and special characters.

If FIPS 140-2 mode is enabled, password must be a random combination of 14 or more uppercase and lowercase letters, numbers, and special characters. The controller will reset to a default username and password when FIPS 140-2 is enabled, and the user will then be prompted to reset both. See [FIPS 140-2 Mode](#).

Do not allow a browser to remember a user's login credentials

When logging into an nLight ECLYPSE controller with certain browsers, the browser asks to remember a user's login credentials. When this option is set, the next time the user logs in, the credentials will automatically be filled in. While this is convenient, anyone with access to the computer can login using those credentials. Do not set this option for administrator accounts or when accessing an account from an unsecure computer.

Account Management and Permissions

User accounts must be properly managed to make it harder for an attacker to compromise security, and to make it easier to detect that an attack has occurred. To set user account parameters, see [User Management](#).

FIPS 140-2 Mode

Enabling FIPS 140-2 mode has an effect on account management and permissions. Once FIPS 140-2 mode is enabled, several controller settings are reset. Therefore, it is best to enable FIPS 140-2 mode before creating accounts and assigning permissions. See [FIPS 140-2 Mode](#).

Use a Different Account for Each User

Each user account should represent an individual user. Multiple users or user groups should not share an account.

Suspending an account shuts-off a single user's access to the controller – it does not disrupt many users.

Permissions can be tailored to the needs of each user. A shared account may have more permissions than all users should have.

A shared account has a shared password which is more likely to be leaked.

It is harder to implement password expiration requirements.

Use Unique Service Type Accounts for Each Project

System integrators should use different credentials for each job they do. Should an attacker gain access to one system, they cannot readily access all systems installed by the same system integrator.

Disable Known Accounts When Possible

Create a new user admin account with new credentials then delete the default admin account. It is easier to attack the default admin account when an attacker only has to guess the password.

Assign the Minimum Required Permissions

When creating a new user account, give that account only the minimum rights to access or modify the system needed for that user.

Use Minimum Possible Number of Admin Users

A compromised admin account can be disastrous as it allows complete access to everything. Only give a user admin privileges only when absolutely necessary.

HTTPS Certificates

HTTPS is a protocol which encrypts HTTP requests and their responses. This ensures that if someone were able to compromise the network, they would not be able to listen in or tamper with the communications.

Make sure that HTTPS is enabled. For more information on how to enable HTTPS, see *Web Server Access*.

Certificates

Generate and install a signed SSL certificate. Refer to *Web Server Access* for information on how to import a custom certificate.

Additional Measures

Update the nLight ECLYPSE Controller's Firmware to the Latest Release

Always keep the nLight ECLYPSE controller's firmware up-to-date. The most recent firmware has the latest bug fixes and stability enhancements.

External Factors

Install nLight ECLYPSE Controllers in a Secure Location

Ensure that the nLight ECLYPSE Controller is installed in a physically secure location, under lock and key. Through physical access, an attacker can take over the controller to do with it what they please.

For example, the reset button can be used to reset the controller to its factory default settings. If FIPS 140-2 mode has been enabled on the controller, resetting a controller to its factory default settings will turn FIPS 140-2 mode off.

Make Sure that nLight ECLYPSE Controllers Are Behind a VPN

For off-site connections, ensure that users access the controllers through a Virtual Private Network (VPN). This helps to prevent an attack through eavesdropping on the communications channel to steal user credentials.

CHAPTER 10

BACNET MS/TP COMMUNICATION DATA BUS FUNDAMENTALS

This chapter describes the BACnet MS/TP Communications Data Bus operating principles.

Topics

BACnet MS/TP Data Transmission Essentials

Maximum Number of BACnet MS/TP Devices on a Data Bus Segment and Baud Rate

Data Bus Physical Specifications and Cable Requirements

Data Bus Topology and EOL Terminations

Data Bus Shield Grounding Requirements

Using Repeaters to Extend the Data Bus

Device Addressing

Power Supply Requirements for 24VAC-Powered Controllers

BACnet MS/TP Data Transmission Essentials

Certain nLight ECLYPSE controller models support BACnet MS/TP to BACnet/IP routing according to the controller model purchased. See the Controller's datasheet for more information. To enable BACnet MS/TP to BACnet/IP routing, see [Routing](#).

The BACnet MS/TP or Modbus RTU network option is selected in the controller's web interface. BACnet MS/TP and Modbus RTU communications are made by connecting directly to separate RS-485 ports. The Connected System Controller integrates up to three RS-485 ports when equipped with one NECY-RS485 extension module allowing the controller to support more than one trunk or communication protocol at a time. When the NECY Series Controller is configured for BACnet MS/TP, values from the connected BACnet MS/TP controllers can be used in ENVYSION graphics hosted on the NECY Series Controller. Furthermore, the NECY Series Controller acts as a BACnet/IP to BACnet MS/TP bridge that allows BACnet objects to be shared among BACnet intra-networks through BBMD. See [BACnet/IP Broadcast Management Device Service \(BBMD\)](#).

The BACnet MS/TP data bus protocol is part of the BACnet[®] ANSI/ASHRAE[™] Standard 135-2008 that uses the EIA-485 (RS-485) physical layer standard for data transmission (herein called the data bus). Multiple data buses can be logically tied together as each BACnet MS/TP data bus is assigned a unique Network Instance that distinguishes it from other data buses in the BACnet MS/TP Local Area Network (LAN).

EIA-485 is a standard that defines the electrical characteristics of the receivers and drivers to be used to transmit data in a differential (balanced) multi-point data bus that provides high noise immunity with relatively long cable lengths which makes it ideal for use in industrial environments. The transmission medium is inexpensive and readily-available twisted pair shielded cable.

While there are many possible LAN topologies for an EIA-485 data bus, only devices that are daisy-chained together are allowed with BACnet MS/TP (see [Figure 74](#)). A spur is only permitted when it is connected to the data bus through a repeater (see [Using Repeaters to Extend the Data Bus](#)).

End-of-line (EOL) terminations are critical to error-free EIA-485 data bus operation. The impedance of the cable used for the data bus should be equal to the value of the EOL termination resistors (typically 120 ohms). Cable impedance is usually specified by the cable manufacturer.

BACnet MS/TP data bus is polarity sensitive

The polarity of all devices that are connected to the two-wire BACnet MS/TP data bus must be respected. The markings to identify the polarity can vary by manufacturer. The following table summarizes the most common identification labels for BACnet MS/TP data bus polarity.

Table 4: Common Identification Labels for BACnet MS/TP Data Bus Polarity for Distech Controls' Products

Acuity Controls and Distech Controls Product	Typical Data Bus Connection Terminals		
	Inverting	Non-inverting	Reference
ECB Series Controllers	NET –	NET +	24V COM
ECB-PTU Series Line-Powered Controllers	NET –	NET +	COM
ECLYPSE Series Controllers	NET –	NET +	S
Thermostat	–	+	Ref
Repeater	Data– Data1–	Data+ Data1+	N/A
BACnet/IP to MS/TP Adapter	RT–	RT+	COM
BACnet/IP to MS/TP Router	–	+	SC



Except for an ECB-PTU Line-Powered Controllers and NECY Series Controllers, never connect the shield of the BACnet MS/TP data bus to the Reference terminal. See [Data Bus Shield Grounding Requirements](#) for more information.

Table 5: Common Identification Labels for BACnet MS/TP Data Bus Polarity for other Manufacturers

Device Manufacturer	Typical Data Bus Connection Terminals		
	Inverting	Non-inverting	Reference
Common identification labels for BACnet MS/TP data bus polarity by other Manufacturers	B	A	SC
	–	+	G
	TxD–/RxD–	TxD+/RxD+	GND
	U–	U+	COM
	RT–	RT+	REF
	Sig–	Sig+	S
	Data–	Data+	



When interfacing with BACnet MS/TP devices from other manufacturers, refer to the documentation provided with the device to correctly wire the device.

Maximum Number of BACnet MS/TP Devices on a Data Bus Segment and Baud Rate

The following technical parameters limit the number of devices on a BACnet MS/TP Data Bus Segment.

- The BACnet MS/TP Data Bus Segment has a hard limit on the number of devices that can communicate due to the device addressing scheme (the MAC Address Range for BACnet MS/TP Devices). See [Data Bus Segment MAC Address Range for BACnet MS/TP Devices](#).
- Each device presents an electrical load on the BACnet MS/TP Data Bus Segment. This is called *device loading*. The number of devices that can be connected to a BACnet MS/TP Data Bus Segment is limited by the loading of each device. See [Device Loading](#).
- Choosing a low baud rate can cause BACnet MS/TP Data Bus congestion that can limit the amount of data that can be efficiently exchanged between devices connected to the BACnet MS/TP Data Bus. For example, at 9600 baud, the maximum number of devices is reduced to 25 due to the increased time it takes for token passing between devices. The recommended baud rate is 38 400. See [Baud Rate](#).
- Distech Controls recommends that you connect no more than 50 of our 1/4 or 1/2-load devices on a single BACnet MS/TP Data Bus Segment when a baud rate of 19 200 or higher is used (preferably 38 400 baud). This is to ensure that the BACnet MS/TP Data Bus has enough bandwidth to efficiently communicate network variables between controllers.

These parameters are described in greater detail below.

Data Bus Segment MAC Address Range for BACnet MS/TP Devices

The BACnet MS/TP data bus supports up to 255 devices:

- Up to 128 devices (with device MAC addresses in the range of 0 to 127) that are BACnet MS/TP Masters (that can initiate communication).
- Up to 128 devices (with device MAC addresses in the range of 128 to 255) that are BACnet MS/TP Slaves (cannot initiate communication).

However, it is recommended that any given data bus segment have no more than 50 devices, when a baud rate of 19 200 or higher is used for the BACnet MS/TP Data Bus. A repeater counts as a device on each data bus segment to which it is connected.

All Distech Controls' devices are categorized as BACnet MS/TP Masters, that is, their device MAC address can be set in the range of 0 to 127 only.

Device Loading

Each device presents an electrical load on the BACnet MS/TP Data Bus Segment. This is called *device loading*. The use of full load devices limits the number of devices connected to a BACnet MS/TP Data Bus Segment to 32 devices. Distech Controls' BACnet MS/TP devices are 1/8-load devices and 1/2-load devices, which allows more devices to be connected to the BACnet MS/TP Data Bus Segment, as compared to full load devices.

Table 6: Device Loading

Manufacturer	Device load on the attached BACnet MS/TP Data Bus
Distech Controls' ECB and ECLYPSE Series controllers Distech Controls' ECB-PTU Series Line-Powered Controllers	1/8-load devices
Distech Controls' BACnet MS/TP Thermostats	1/2-load devices
Other manufacturers	Refer to their documentation

However, if a data bus segment is interoperating with devices that are full-load, 1/2-load, 1/4-load, or 1/8-load, then the device that supports the fewest devices on the same data bus is the one that sets the limit for the maximum total number of devices for that data bus segment. For example, you plan to put on one data bus the following devices:

Table 7: Device Loading Example

Manufacturer	Quantity of devices (example)	Equivalent full-load devices	Maximum devices supported by the manufacturer
Distech Controls' devices (1/8-load devices)	8	1	128 ¹ Maximum 50 recommended
Distech Controls' BACnet MS/TP Thermostats (1/2-load devices)	14	7	64 Maximum 50 recommended
Manufacturer Y (full load devices)	26	26	32
Total Full-Load Devices		34	There are too many devices on the data bus. It is limited to a maximum of 32 devices by Manufacturer's Y devices.

1. This is limited by the maximum number of master devices allowed on a BACnet MS/TP Data Bus.

The solution for the above example is to create two data bus segments connected together by a repeater and then split up the devices between the data bus segments, ensuring again that the maximum number of devices on each separate data bus is not exceeded. See [Using Repeaters to Extend the Data Bus](#).

Baud Rate

Most devices will have a range of baud rate settings and possibly an AUTO setting that detects the baud rate of other devices transmitting on the data bus and adjusts the baud rate of the device accordingly. Typical baud rates are 9600, 19 200, 38 400, and 76 800. The baud rate setting determines the rate at which data is sent on the BACnet MS/TP data bus.



At 9600 baud, the maximum number of devices is reduced to 25 due to the increased time it takes for token passing between devices.

All devices on the data bus must be set to the same baud rate. Therefore, the chosen baud rate must be supported by all devices connected to the data bus.

The recommended baud rate for Distech Controls' devices is 38 400.

We recommend that you:

- Set the baud rate of two controllers on a BACnet MS/TP Data Bus Segment to the same baud rate to provide failover protection.
- For example, set the baud rate of the NECY Series Controller (if equipped) and one other controller to 38 400 baud. If the NECY Series Controller *becomes* unavailable and there is a power cycle, the ECB controller will set the baud rate for the BACnet MS/TP Data Bus.
- Set all other devices to automatically detect the baud rate, if this option is available.

Figure 70: Setting the Baud rate on two Controllers on a BACnet MS/TP Data Bus Segment for Failover Protection

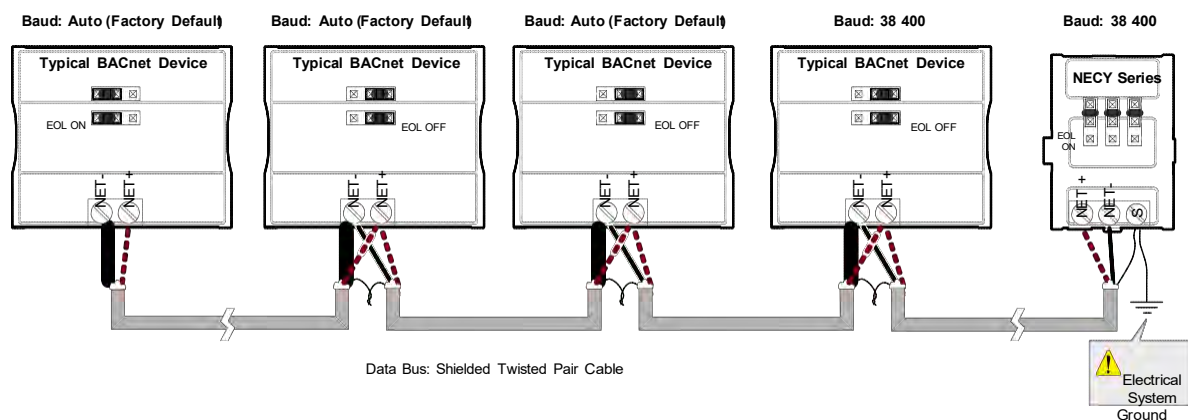

To set the baud rate for:

- NECY Series Controllers, see [Network Settings](#).
- ECB Series controllers, see the controller's hardware installation guide or the [NetworkGuide](#).

Data Bus Physical Specifications and Cable Requirements

Cables composed of stranded conductors are preferred over solid conductors as stranded conductor cable better resist breakage during pulling operations. Distech Controls strongly recommends that the following data bus segment cable specifications be respected.

Table 8: BACnet MS/TP Data Bus Segment Physical Specifications and Cable Requirements

Parameter	Details
Media	Twisted pair, 24 AWG (see also Metric Conversions for Wire Gauge)
Shielding	Foil or braided shield
Shield grounding	The shield on each segment is connected to the electrical system ground at one point only; see Data Bus Shield Grounding Requirements .
Characteristic impedance	100-130 Ohms. The ideal is 100-120 Ohms.
Distributed capacitance between conductors	Less than 100 pF per meter (30 pF per foot). The ideal is less than 60 pF per meter (18 pF per foot).
Distributed capacitance between conductors and shield	Less than 200 pF per meter (60 pF per foot).
Maximum length per segment	1220 meters (4000 feet)
Data Rate	9600, 19 200, 38 400, and 76 800 baud
Polarity	Polarity sensitive
Multi-drop	Daisy-chain (no T-connections)
EOL terminations	120 ohms at each end of each segment
Data bus bias resistors	510 ohms per wire (max. of two sets per segment)

Shielded cable offers better overall electrical noise immunity than non-shielded cable. Unshielded cable or cable of a different gauge may provide acceptable performance for shorter data bus segments in environments with low ambient noise.

Table 9: Distech Controls Recommended Cable Types for BACnet MS/TP Data Buses

Cable Type	Part Number	O.D. (Ø)
300 meters (1000 feet), 24 AWG Stranded, Twisted Pair Shielded Cable – FT6, Rated for Plenum Applications	CB-BACN6BL1000	3.75mm (0.148 in.)

Distech Controls BACnet cable offers the best performance over the full range of baud rates, cable lengths, and number of connected devices. This is primarily due to lower conductor-to-conductor capacitance of this cable.

Data Bus Topology and EOL Terminations

Function of EOL Terminations

The first and last device on the data bus must have End-of-Line (EOL) termination resistors connected across the two data lines/wires of the twisted pair. These resistors serve the following purposes:

- EOL terminations dampen reflections on the data bus that result from fast-switching (high-speed rising and falling data edges) that otherwise would cause multiple data edges to be seen on the data bus with the ensuing data corruption that may result. The higher the baud rate a data bus is operating at, the more important that EOL terminations be properly implemented. Electrically, EOL terminations dampen reflections by matching the impedance to that of a typical twisted pair cable.
- EIA-485 data bus transmitters are tri-state devices. That is they can electrically transmit 1, 0, and an idle state. When the transmitter is in the idle state, it is effectively off-line or disconnected from the data bus. EOL terminations serve to bias (pull-down and pull-up) each data line/wire when the lines are not being driven by any device. When an un-driven data bus is properly biased by the EOL terminations to known voltages, this provides increased noise immunity on the data bus by reducing the likelihood that induced electrical noise on the data bus is interpreted as actual data.

When to Use EOL Terminations

EOL terminations should only be enabled / installed on the two devices located at either end of the data bus. All other devices must not have the EOL terminations enabled/installed.

Figure 71: EOL Terminations Must be Enabled at Both the First and Last Device on the Data Bus

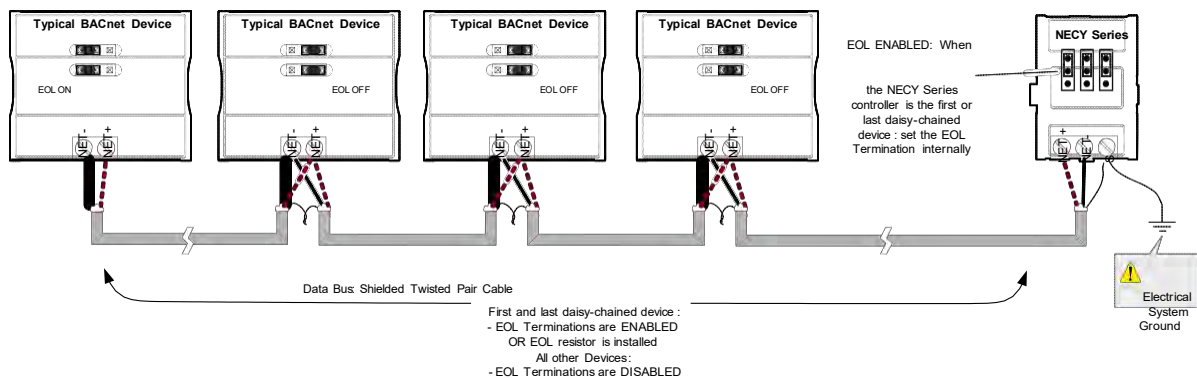

Devices with built-in EOL terminations are factory-set with the EOL termination disabled by default.



The *BACnet/IP to MS/TP Adapter* does not have EOL Termination (and BACnet MS/TP Data Bus biasing) capabilities to be used at the end of a BACnet MS/TP data bus. Instead, use the *BACnet/IP to MS/TP Router* for this application.

When to use EOL Terminations with BACnet MS/TP Thermostats

BACnet MS/TP thermostats support external EOL termination resistors only. When a BACnet MS/TP thermostat is the first or last daisy-chained device, add a 120 Ohm resistor across the – and + BACnet MS/TP data bus connections.

The BACnet MS/TP data bus must be biased. This bias can only be provided by built-in EOL termination resistors (ones set with jumpers or DIP switches – refer to the controller’s Hardware Installation Guide for how to identify and set a controller’s built-in EOL terminations). If a BACnet MS/TP data bus has a BACnet MS/TP thermostat at one end of the BACnet MS/TP data bus and an NECY Series Controller at the other end, you must set the built-in EOL termination in the NECY Series Controller so that proper biasing is provided to the BACnet MS/TP data bus.

Figure 72: Typical EOL Terminations with BACnet MS/TP Thermostats with Biasing Provided by the NECY Series Controller’s Built-in EOL Termination set to ON

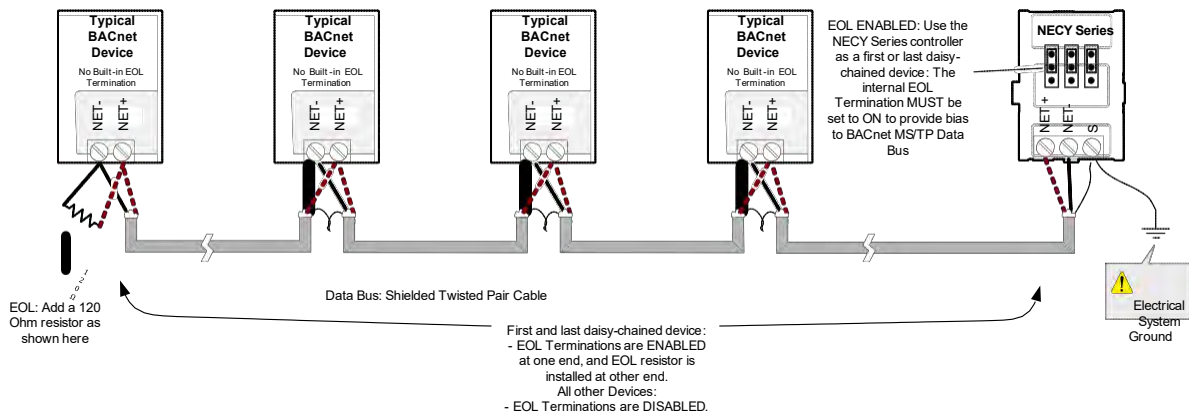

About Setting Built-in EOL Terminations

NECY Series Controllers have built-in EOL terminations. These Controllers use jumpers or DIP switches to enable the EOL resistors and biasing circuitry. These controllers have separate bias and EOL termination settings. This is useful in the following scenario: the NECY series controller is located in the middle of the data bus and either one or both controllers at the data bus ends do not have biasing or EOL terminations. In this situation, set the bias on the NECY series controller and set the EOL termination on the controllers at the end of the data bus. If a controller at the end of the data bus does not have a

built-in EOL termination, then add a 120 Ohm resistor across the device's terminals as shown at the left side of [Figure 72](#).

Figure 73: Typical nLight ECLYPSE Controller with Separate EOL Termination and Bias Configuration Settings

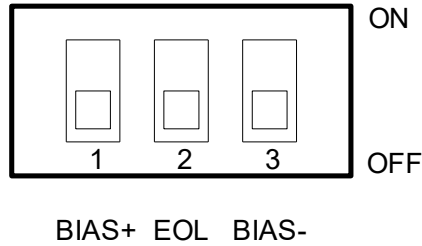

ECB-PTU Series Line-Powered Controllers use DIP switches (found alongside those DIP switches used to set the MAC address) to enable the built-in EOL resistors and biasing circuitry.

ECB Series 24V-Powered Controllers have built-in EOL terminations. These Controllers use jumpers to enable the EOL resistors and biasing circuitry.

Refer to the controller's Hardware Installation Guide for how to identify and set a controller's built-in EOL terminations.

Only a Daisy-Chained Data Bus Topology is Acceptable

Use a daisy-chained BACnet MS/TP data bus topology only. No other data bus topology is allowed.

Figure 74: Typical BACnet MS/TP LAN Topology Showing How Devices are Daisy-Chained Together to Form One Data Bus Segment

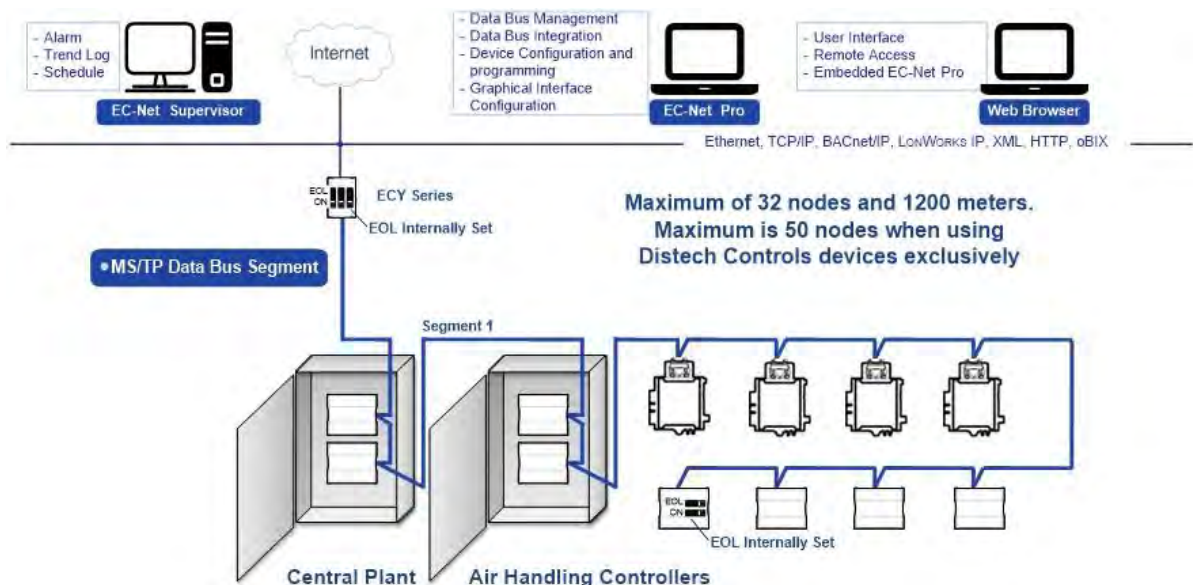



Only linear, daisy-chained devices provide predictable data bus impedances required for reliable data bus operation.

Only a daisy-chained data bus topology should be specified during the planning stages of a project and implemented in the installation phase of the project.

A spur is only permitted when it is connected to the data bus through a repeater (see [Using Repeaters to Extend the Data Bus](#)).

Figure 75: Unsupported BACnet MS/TP LAN Topologies

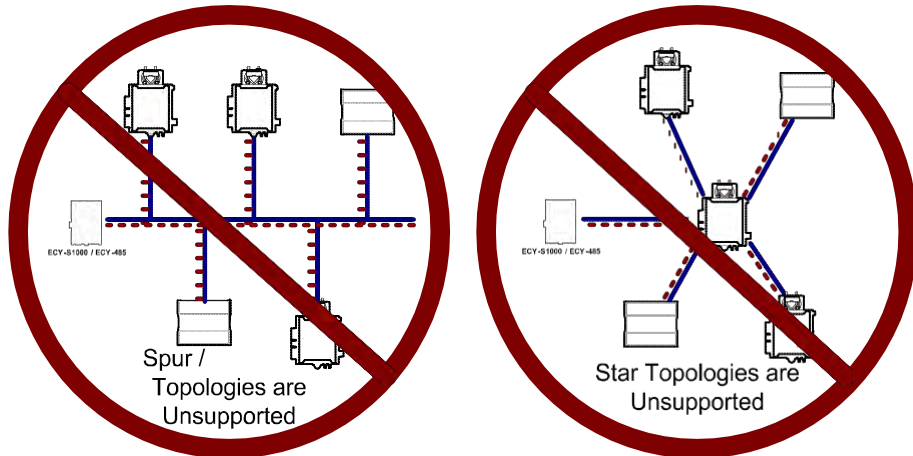

Data Bus Shield Grounding Requirements

The EIA-485 data bus standard requires that the data bus must be shielded against interference. A BACnet MS/TP data bus must also be properly grounded.

For ECB Series 24V-Powered Controllers: The data bus' cable shields must be twisted together and isolated with electrical tape at each device. Note that for ECB 24V-Powered Controllers, the power supply transformer's secondary that is connected to the 24V COM terminal is grounded. This provides the ground reference for the data bus (see [BACnet MS/TP is a Three-Wire Data Bus](#)). If the controller is at the end of the BACnet MS/TP data bus, simply isolate the data bus shield with electrical tape.

For ECB-PTU Series Line-Powered Controllers: The data bus' cable shields must be twisted together and connected to the **COM** terminal at each ECB-PTU Line-Powered Controller. Keep the cable shield connections short and take steps at each device to isolate the cable shield from touching any metal surface by wrapping them with electrical tape, for example. Note that for ECB-PTU Line-Powered Controllers, the data bus' cable shield provides the ground reference for the data bus (see [BACnet MS/TP is a Three-Wire Data Bus](#)). If the controller is at the end of the BACnet MS/TP data bus, simply connect the data bus shield to the **COM** terminal.

ECLYPSE Series Controller: The data bus' cable shields must be twisted together and connected to the **S** terminal at each ECLYPSE Series Controller. Keep the cable shield connections short and take steps at each device to isolate the cable shield from touching any metal surface by wrapping them with electrical tape, for example. Note that for ECLYPSE Series Controller, the data bus' cable shield provides the ground reference for the data bus (see [BACnet MS/TP is a Three-Wire Data Bus](#)). If the controller is at the end of the BACnet MS/TP data bus, simply connect the data bus shield to the **S** terminal.



Grounding the shield of a data bus segment in more than one place will more than likely reduce shielding effectiveness.

ECB 24V-Powered Controller Data Bus Shield Grounding Requirements

The shield on each data bus segment must be connected to the electrical system ground at one point only, for example, at the NECY Series Controller, as shown below in [Figure 76](#) and [Figure 77](#).

Series Controller located at the End of the Data Bus

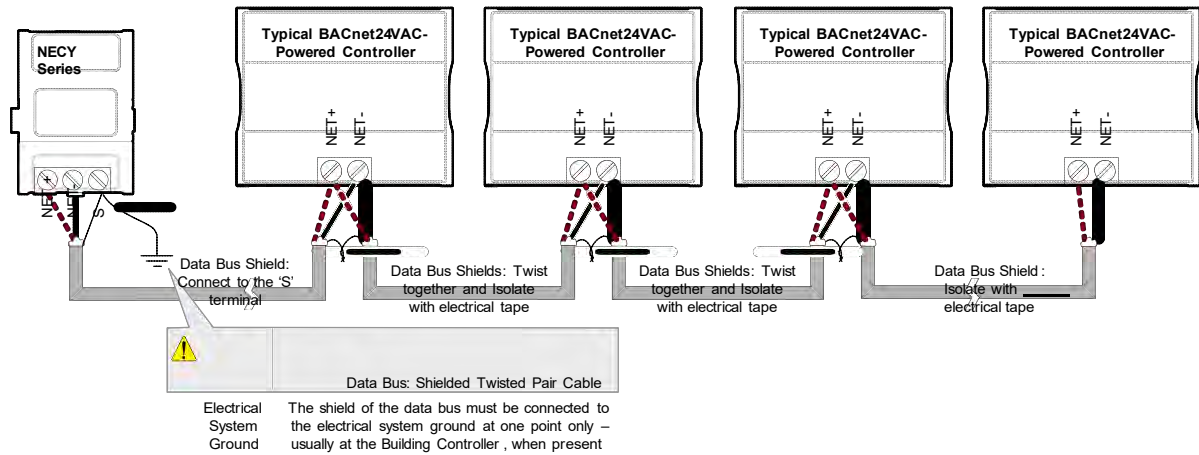
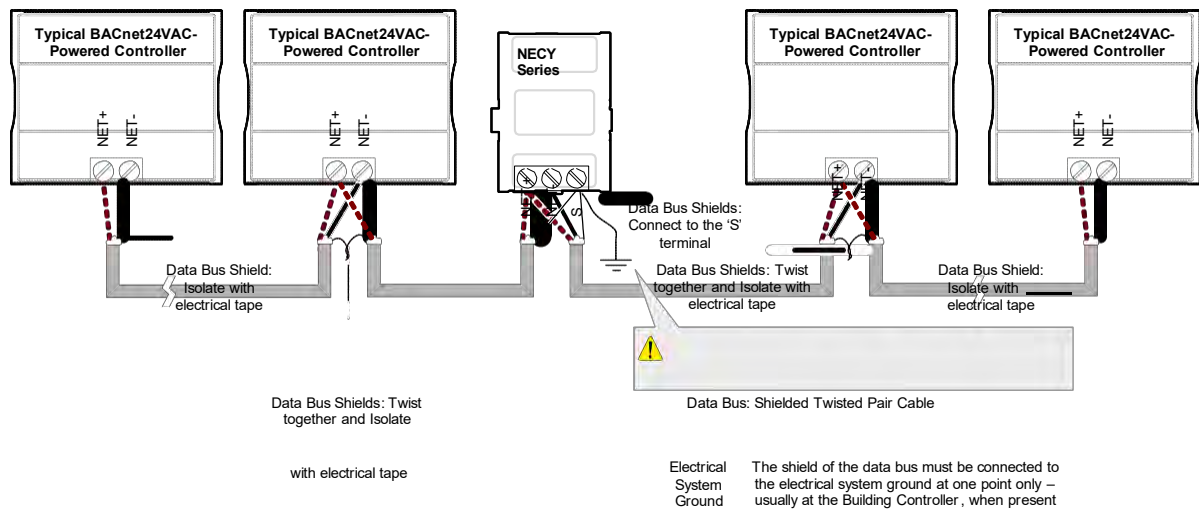

Figure 77: Typical Cable-Shield Grounding Requirements for a BACnet MS/TP Data Bus Segment with an NECY Series Controller located in the Middle of the Data Bus



ECB-PTU Line-Powered Data Bus Controller Shield Grounding Requirements

The shield on each data bus segment must be connected to the electrical system ground at one point only, for example, at the NECY Series Controller, as shown below [Figure 78](#) and [Figure 79](#).

Figure 78: Typical Cable-Shield Grounding Requirements for a BACnet MS/TP Data Bus Segment with an NECY Series Controller located in the End of the Data Bus

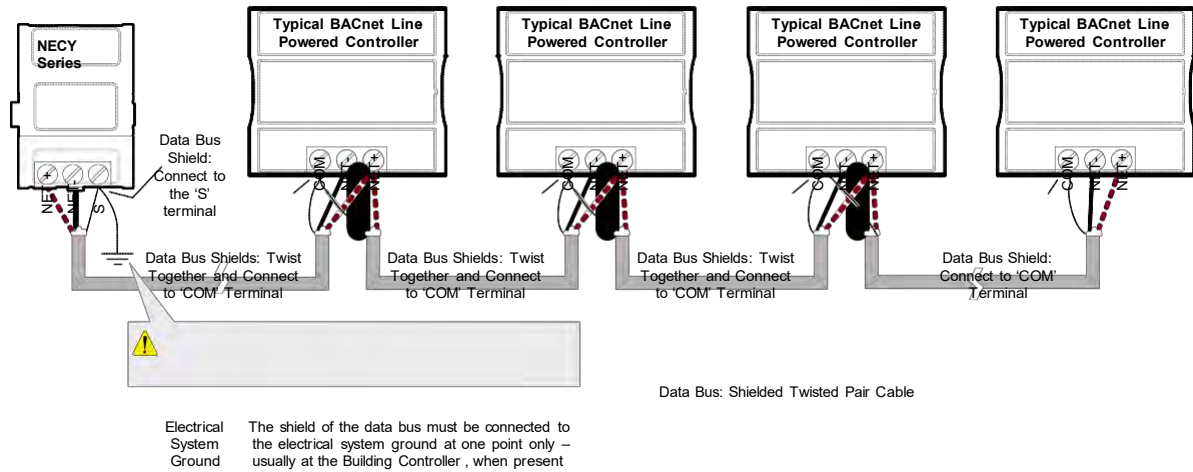
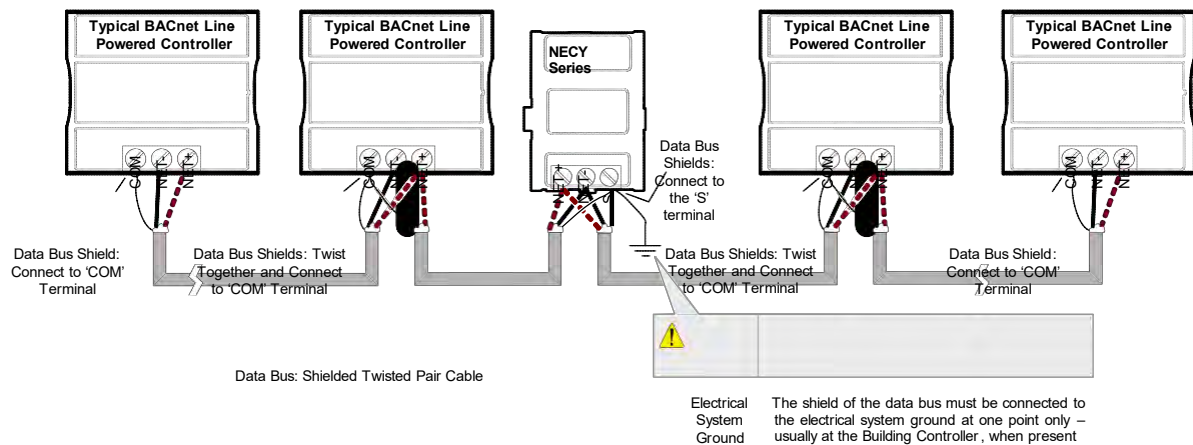

Figure 79: Typical Cable-Shield Grounding Requirements for a BACnet MS/TP Data Bus Segment with an NECY Series Controller located in the Middle of the Data Bus



Data Bus Shield Grounding Requirements When Mixing Both ECB 24V-Powered Controllers and ECB-PTU Line-Powered Controllers

The shield on each data bus segment must be connected to the electrical system ground at one point only, for example, at the NECY Series System Controller, as shown below [Figure 80](#) and [Figure 81](#).

Series Controller located in the End of the Data Bus

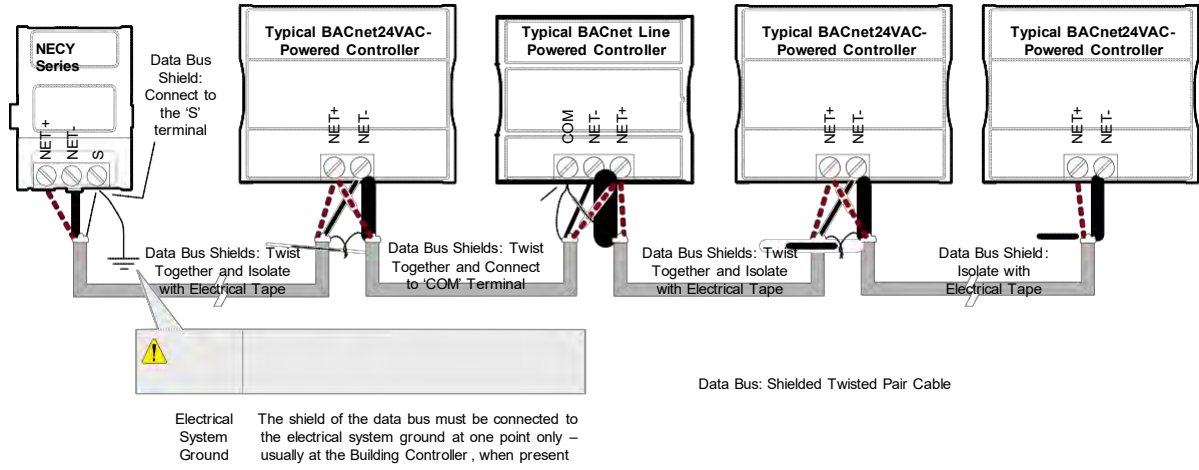
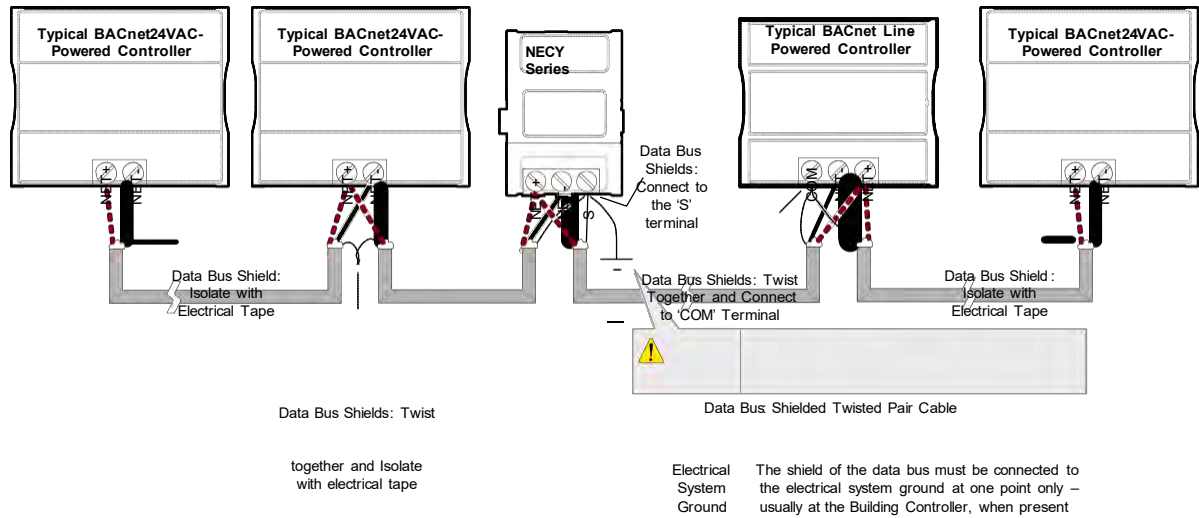

Figure 81: Typical Cable-Shield Grounding Requirements for a BACnet MS/TP Data Bus Segment with an NECY Series Controller located in the Middle of the Data Bus



Using Repeaters to Extend the Data Bus

A BACnet MS/TP data bus segment can be up to 1220 meters (4000 feet) long with up to a maximum of 50 devices. When a greater length is required, a solution is to use a repeater. A repeater increases the maximum length of the data bus.

Using a Repeater to Extend the Length of the BACnet MS/TP Data Bus

Repeaters can be used to extend a BACnet MS/TP data bus up to 3660 meters maximum total length. Do not use more than two repeaters on a BACnet MS/TP LAN.

A BACnet MS/TP repeater is a bi-directional device that regenerates and strengthens the electrical signals that pass through it. It creates two electrically-isolated BACnet MS/TP data bus segments that transparently enable devices on one side of the repeater to communicate with any device on the other side. The two BACnet MS/TP data bus segments have the same requirements of an ordinary BACnet MS/TP data bus segment; that is, each BACnet MS/TP data bus segment:

- Can be up to 1220 meters (4000 feet) long.
- The first and last device on the data bus must have End-of-Line (EOL) termination resistors connected across the two data lines/wires of the twisted pair.
- Must respect the maximum limit for [Device Loading](#).
- Will have the same network number as they remain part of the same network or LAN.

It is recommended that you connect no more than 50 of our $\frac{1}{8}$ or $\frac{1}{2}$ -load devices on all BACnet MS/TP Data Bus repeater segments when a baud rate of 19 200 or higher is used (preferably 38 400 baud). This is to ensure that the BACnet MS/TP Data Bus has enough bandwidth to efficiently communicate network variables between controllers.



Do not use more than two repeaters on a BACnet MS/TP data bus. A repeater can only connect two BACnet MS/TP data bus segments even if it has ports to support more than two BACnet MS/TP data bus segments.

A repeater can be added anywhere to a data bus segment including the end of the segment as shown below.

Figure 82: Using a Repeater to Extend the Range of the LAN

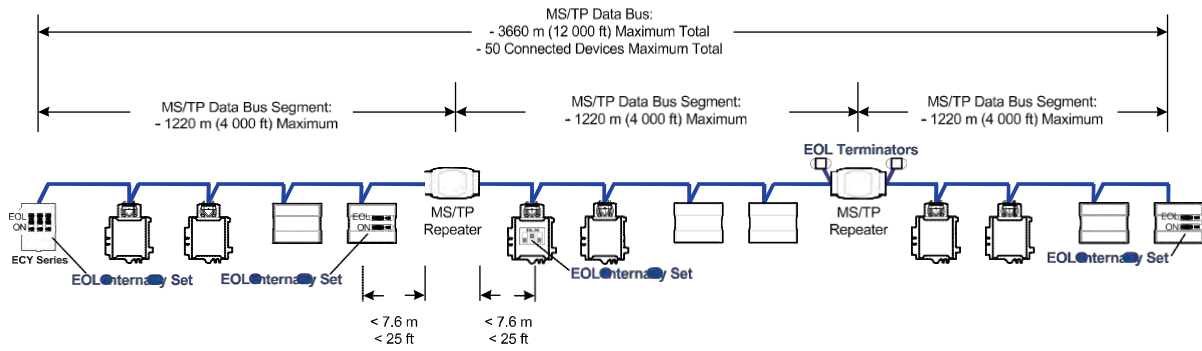

A repeater can be used to create a spur as shown below.

Figure 83: Adding a Spur by Using a Repeater

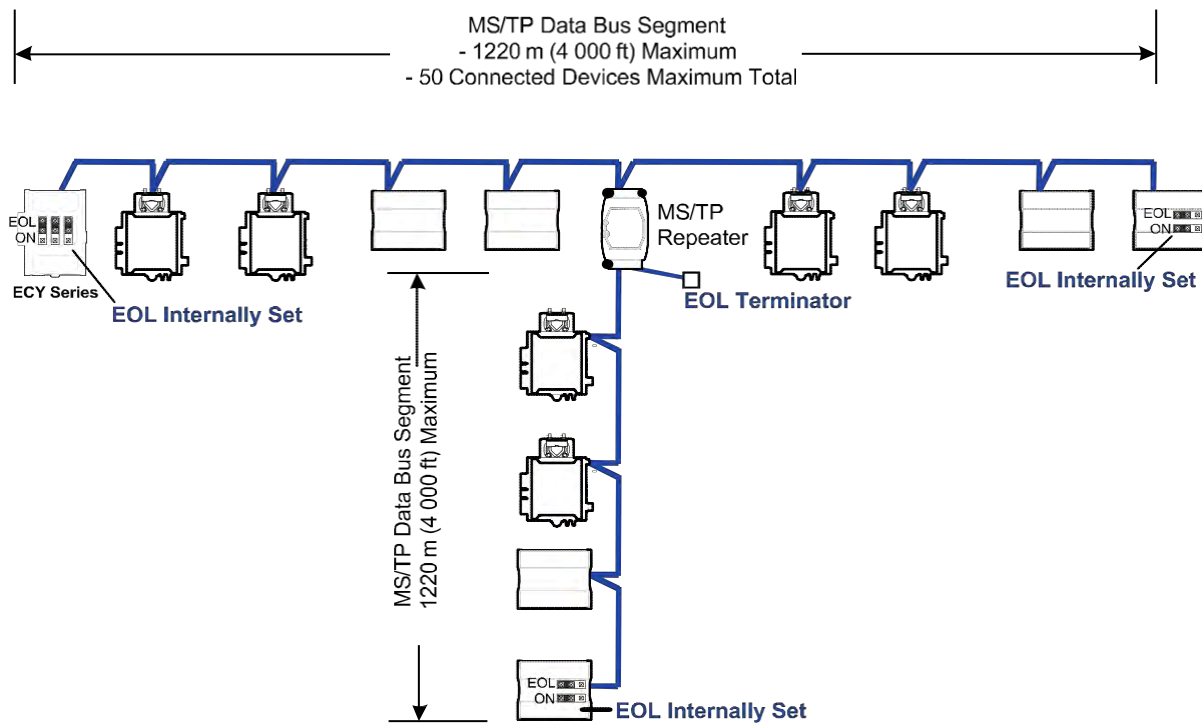

A repeater is counted as a device on each data bus to which it is connected.

When third party devices are connected to a data bus segment, the number of devices that can be connected to that data bus segment may be reduced. See [Device Loading](#).

Figure 84: Repeater Connections when it is the First or Last Device on its Respective Data Bus Segment

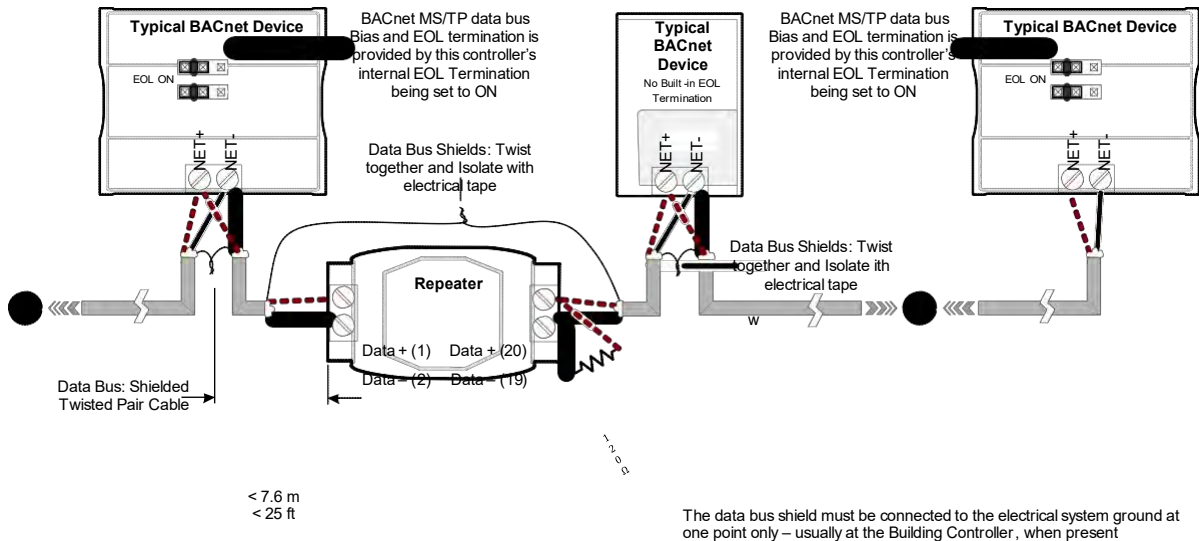

The BACnet MS/TP Data Bus must be biased. This bias can only be provided by built-in EOL termination resistors (ones set with a jumper or DIP switch). When a repeater is the first or last device on its respective data bus segment, use the following methods to provide MS/TP Data Bus biasing and EOL termination as applicable to your situation:

1. On the BACnet MS/TP data bus segment ❶ shown in [Figure 84](#), bias and EOL termination is provided by a controller’s built-in EOL termination being set to ON. In this case the connection to the repeater cannot be more than 7.6 meters (25 feet) from this controller.
2. On the BACnet MS/TP data bus segment ❷ shown in [Figure 84](#), a 120Ω EOL Termination resistor is added to the repeater’s terminals. Biasing for this BACnet MS/TP data bus segment is provided by the built-in EOL termination being set to ON at the last controller at the other end of this data bus.

See [When to Use EOL Terminations](#) for more information. The shield of one data bus must be grounded at one point as specified in [Data Bus Shield Grounding Requirements](#). The shields of the two data buses must be connected together and isolated with electrical tape as shown in [Figure 84](#). Refer to the controller’s Hardware Installation Guide for how to identify and set a controller’s built-in EOL terminations.

Device Addressing

Device addressing allows the coordinated transfer of messages between the intended devices on the BACnet MS/TP data bus and with devices connected to the internetwork. For this, each device connected to the BACnet MS/TP data bus is identified by a MAC address, a Device Instance number, and a Network Number:

- The MAC Address uniquely identifies a device on a Network (identified by a Network Number). Devices on another Network can have the same MAC Address as messages are not passed at the internetwork level using the MAC Address. The MAC Address also defines the devices on the data bus that are Masters and Slaves, among other categories (see [Table 10](#)). The MAC Address is also used to share data bus bandwidth between devices through token passing between Master devices.
- The Device Instance uniquely identifies a device across the BACnet internetwork. The Device Instance is any number between 0 and 4 194 303. It is with the Device Instance that messages are exchanged between BACnet devices. The Device Instance is also used by routers to forward messages to devices located elsewhere in the internetwork. Unlike a MAC Address, a Device Instance cannot be reused elsewhere in the BACnet internetwork (it must be unique for the entire network).
- The Network Number is any number between 1 and 65 534. A network number identifies a LAN for routing purposes.

Both the MAC Address and the Device Instance must be set for each device and are essential for proper BACnet LAN operation.

For an example of how MAC address, Device Instance number, and Network Number apply to a typical BACnet network, see [Figure 86](#).

About the MAC Address

The MAC Address is a number from 0 to 255; however, we recommend reserving some MAC Addresses for common commissioning and maintenance tasks. For example, when a portable adapter is set to use one of these reserved MAC Addresses, it can be temporarily connected with certainty to any BACnet MS/TP data bus of any site without conflicting with other devices already connected to the BACnet MS/TP data bus. We strongly recommend that the MAC address of NECY Series Controller's MS/TP port be always set to 0.

MAC Addresses should be used as shown in the following table.

Table 10: Recommended BACnet MS/TP Bus MAC Address Values / Ranges for BACnet MS/TP Data Bus Devices

MAC Address Value / Range	Usage	Devices
0	Data Bus Master (NECY Series Controller)	This address is invalid for Distech Controls' ECB series devices
1	Temporary commissioning connection	This address is invalid for Distech Controls' ECB series devices
2	Reserved	Other
3-127	Master Range	Master devices: All Distech Controls' devices are master devices and should be in this MAC Address range
128-254	Slave Range	Slave devices and network sensors
255	Broadcast	Do not apply address 255 to any device

BACnet MS/TP Data Bus Token-Passing Overview

The BACnet MS/TP data bus protocol is a peer-to-peer, multiple-master protocol that shares data bus bandwidth by passing a token between Master devices on the data bus that authorizes the device that is holding the token to initiate communications on the data bus. Once the device has completed its request(s), it closes the communications channel, passes the token to the next Master device (making it the current Master), and liberates the data bus.

The token is passed through a short message from device to device on the BACnet MS/TP data bus in consecutive order starting from the lowest MAC address (MAC Address = 0) to the next MAC Address.

Gaps or pockets of unassigned device MAC Addresses should be avoided as this reduces data bus performance. Once a master has finished making its requests, it must poll for the next master that may exist on the Data Bus. It is the timeout for each unassigned MAC Address that slows down the data bus.

The way MAC Addresses are assigned is not a physical requirement: Devices can be daisy-chained on the data bus in any physical order regardless of their MAC Address sequence. The goal is to avoid gaps in the device MAC Address range.

Slave devices cannot accept the token, and therefore can never initiate communications. A Slave can only communicate on the data bus to respond to a data request addressed to it from a Master device. Gaps in slave device MAC Addressing have no impact on BACnet MS/TP data bus performance.

Figure 85: Setting the Max Master on the NECY Series Controller to the Highest MAC Address Used on the BACnet MS/TP Data Bus

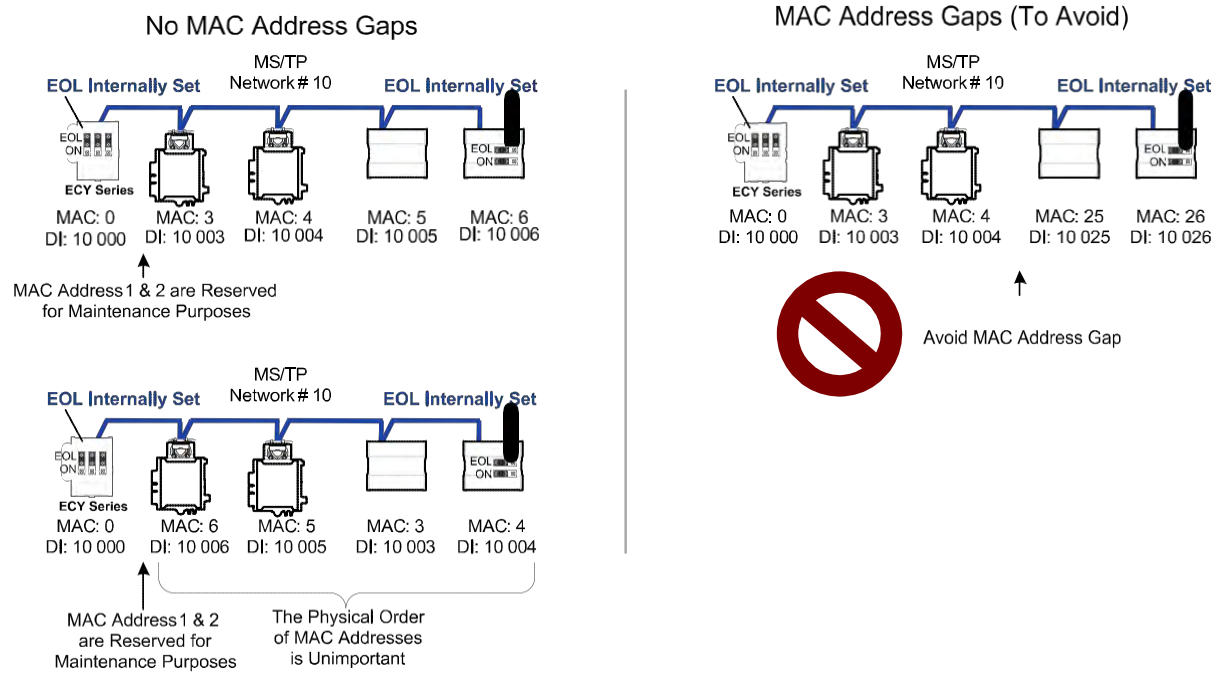

About Tuning the Max Info Frames Parameter

Once a device has the token, it can make a number of information requests to other devices on the BACnet intranetwork. The maximum number of requests is limited by the **Max Info Frames** parameter. Once the device has made the maximum number of requests it is permitted to make according to the **Max Info Frames** parameter, the device passes the token to the following device with the next higher MAC address. This makes the BACnet MS/TP Data Bus more reactive for all devices by preventing a device from hanging on to the token for too long. Ordinary BACnet MS/TP devices should have the **Max Info Frames** parameter set to between 2 and 4. The Data Bus Master (NECY Series Controller) should have the **Max Info Frames** parameter set to 20.

About Tuning the Max Master Parameter

To prevent the passing of the token to unused MAC Addresses situated after the final Master device, the Max Master parameter must be set. By default, the Max Master for an NECY Series Controller or a Supervisor is set to 127 which allows for the theoretical maximum of 127 devices besides the Data Bus Master to be connected to the data bus.

In practice, the actual number of devices connected to a data bus is far less, resulting in a gap between the highest MAC Address of any device connected to the data bus and the value set for Max Master. This gap unnecessarily slows-down the data bus with Poll for Master requests.

When commissioning a BACnet MS/TP Data Bus, it is useful to start with the Max Master set to 127 so as to be able to discover all devices connected to

the data bus. Then, once all devices have been discovered and the MAC Addressing is finalized by eliminating any gaps in the address range, set the **Max Master** (maximum MAC Address) in the NECY Series Controller and in the Supervisor to the highest Master device's MAC Address number to optimize the efficiency of the data bus.

Setting the Max Master and Max Info Frames

The **Max Master** and **Max Info Frames** are parameters used to optimize a BACnet MS/TP Data Bus. This is set in the NECY Series Controller and separately with the Supervisor for each connected BACnet MS/TP device.

For the NECY Series Controller, set the **Max Info Frames** to 20 in the screen shown in **BACnet Settings** of the [Network MS/TP Ports](#) as this is a device that will make more requests for service from other devices on the network. In general, according to the way a device is programmed, the **Max Info Frames** may have to be set to a higher value than for other devices. For example, when Roof Top Unit Controllers are used with VAV controllers that use *gfx* Applications code, they should also have their **Max Info Frames** set to a higher value such as 5, as Roof Top Unit Controllers will poll many VAV controllers for information.

To set the **Max Master** and **Max Info Frames** for BACnet MS/TP devices (for example, an ECB series controller), use a Supervisor to do so. See the [NetworkUserGuide](#) for more information.

Default Device Instance Number Numbering System for Acuity Controls' controllers

By default, controllers from Distech Controls automatically self-assign a Device Instance number generated from the unique MAC Address assigned to the controller during installation. The Device Instance number is calculated as follows:

Device Instance number = 364 X 1000 + MAC Address

Where 364 is Distech Controls unique BACnet Manufacturer ID.

This Numbering system is sufficient for a BACnet network that has only one NECY Series Controller. For larger BACnet networks that have more than one NECY Series Controller (to form a BACnet intranetwork), set the MAC Addresses, Device Instance Numbers and Network Numbers according to the numbering scheme below.

Adopting a Numbering System for MAC Addresses, Device Instance Numbers, and Network Numbers

Good network planning requires a well-thought-out numbering scheme for device MAC Addresses, Device Instance Numbers (DI), and Network Numbers. We recommend the following scheme, as it reuses the MAC Address and Network Number in the Device Instance number to make it easier for a

network administrator to know where a device is located in the network. This is shown below.

Table 11: Recommended Numbering Scheme for MAC Addresses, Instance Numbers, and Network Numbers

Description	Range	Example
BACnet/IP Network Number	0 to 65 534	1
NECY Series Controller BACnet/IP Device Instance Numbers: Multiples of 10 000	10 000 to 4 190 000	10 000 20 000
BACnet MS/TP Network Number: NECY Series Controller BACnet/IP Device Instance Number/1000 + 0,1,2,3,4 (for each LAN)	10 to 4190	10 20 30
BACnet MS/TP Device Instance Number = NECY Series Controller BACnet MS/TP Network Number * 1000 + MAC Address	10 000 to 4 190 256	10 006 where MAC = 6

An example of this numbering system is shown below.

Figure 86: BACnet MS/TP Numbering System for MAC Addresses, Device Instance Numbers, and Network Numbers

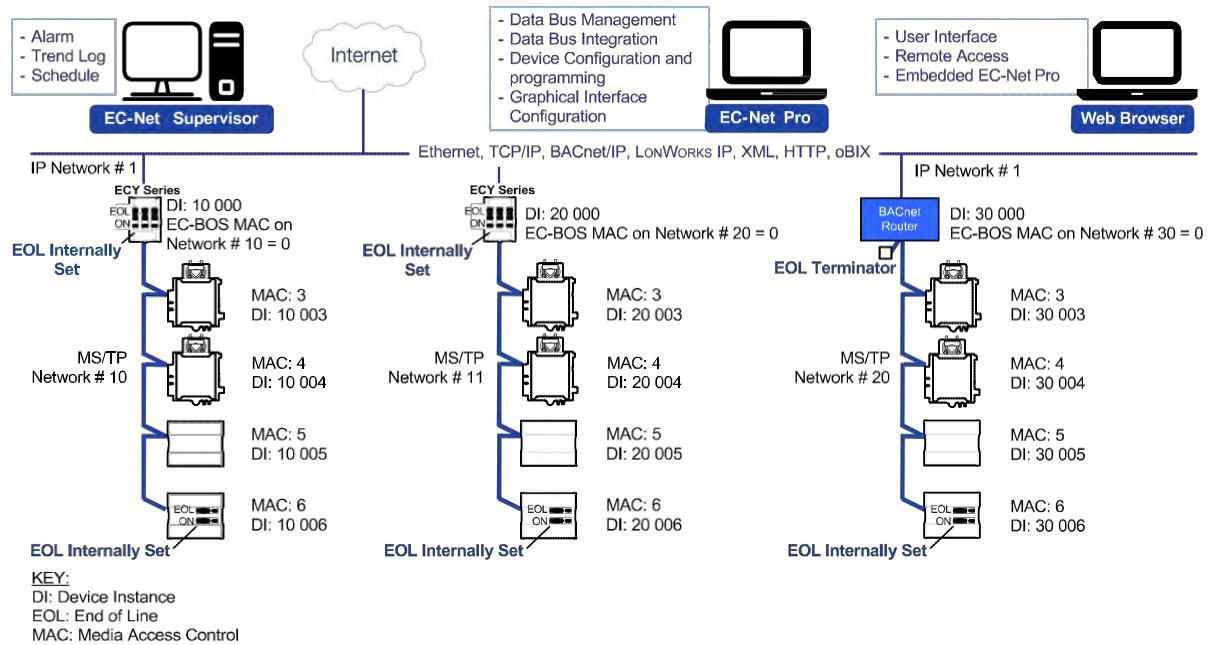

When discovering devices with EC-Net which has the routing option configured, it will discover all BACnet devices connected to all NECY Series Controllers when routing is enabled (see [Routing](#)). Make sure to add only the devices connected to the MS/TP port of the specific NECY Series Controller being configured. Using this numbering system will greatly help to identify those devices that should be added to a given NECY Series Controller.

Setting the NECY Series Controller's MAC Address

The NECY Series Controller's MAC address can be set in **BACnet Settings** of the *nLight ECLYPSE Web Interface*.

Inter-Building BACnet Connection

BACnet network connections between buildings must be made using BACnet/IP as shown below.

Figure 87: Typical Inter-Building Connection Using BACnet/IP or FOX

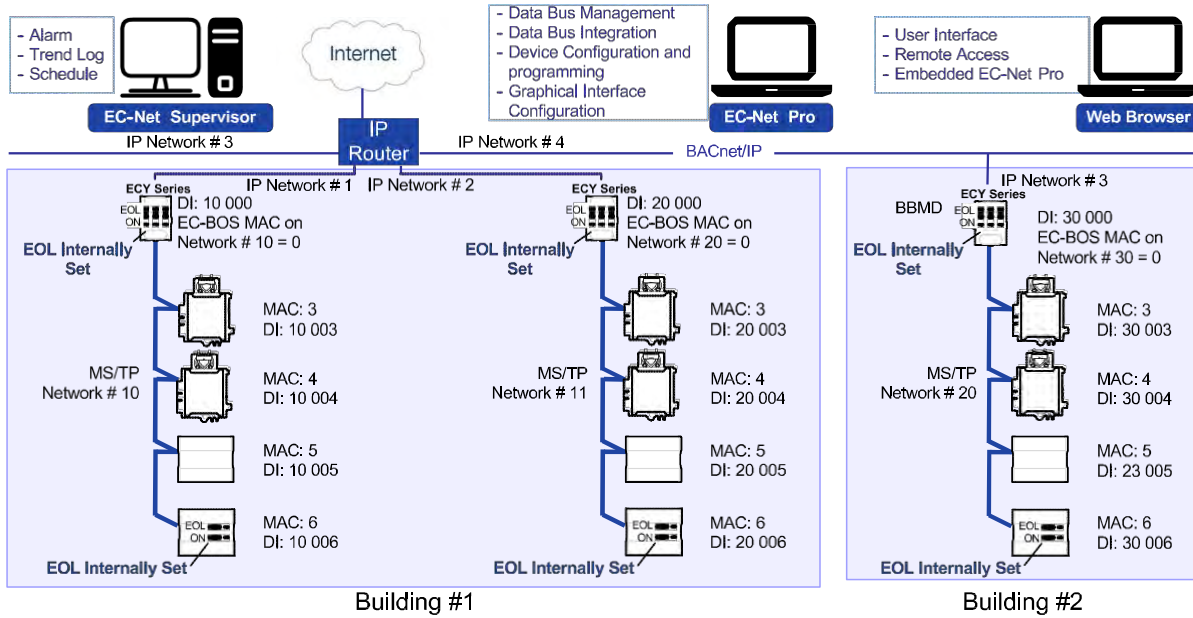

KEY:
 DI: Device Instance
 EOL: End of Line
 MAC: Media Access Control

BACnet/IP Broadcast Management Device Service (BBMD)

Though BACnet/IP uses IP protocol to communicate, a standard IP router does not forward broadcast messages which are important in BACnet to identify services that are available within the BACnet internetwork.

When two NECY Series Controllers communicate to each other over a standard IP connection that is separated by an IP router, both NECY Series Controllers need the BACnet/IP Broadcast Management Device (BBMD) service to be configured and operational.

The BBMD service identifies BACnet messages on the BACnet MS/TP network that are intended for a device located on another BACnet network. The BBMD service encapsulates these messages into an IP message to the appropriate BBMD service of the other BACnet MS/TP network(s). The BBMD service on these networks strips out the encapsulation and sends the BACnet message on to the appropriate devices.

When sending BACnet messages across a standard IP connection that has an IP router, there must be one BBMD service running on each BACnet MS/TP network.

Power Supply Requirements for 24VAC-Powered Controllers

BACnet MS/TP is a Three-Wire Data Bus

Even though data is transmitted over a 2-wire twisted pair, all EIA-485 transceivers interpret the voltage levels of the transmitted differential signals with respect to a third voltage reference common to all devices connected to the data bus (signal reference). In practice, this common signal reference is provided by the building's electrical system grounding wires that are required by electrical safety codes worldwide. Without this signal reference, transceivers may interpret the voltage levels of the differential data signals incorrectly, and this may result in data transmission errors.



PS100-240 Power Supply is a double-insulated device and therefore is not grounded. The reference for the BACnet MS/TP data bus is made by connecting the shield of the BACnet MS/TP data bus to the ECLYPSE Series Controller's **S** terminal to provide a signal reference. This shield is grounded at one point only – see [Data Bus Shield Grounding Requirements](#).

Avoid Ground Lift

24V Power wiring runs should not be too long, nor have too many devices connected to it. Wiring used to supply power to devices has a resistance that is proportional to the length of the wiring run (See [Table 12](#)).

Table 12: Resistance of Common Copper Wire Sizes

AWG	Diameter		Area		Copper wire resistance	
	Range	(mm)	(kcmil)	(mm ²)	(Ω/km)	(Ω/1000 ft.)
14	0.0641	1.628	4.11	2.08	8.286	2.525
16	0.0508	1.291	2.58	1.31	13.17	4.016
18	0.0403	1.024	1.62	0.823	20.95	6.385

If the power run from the power supply is relatively long and it supplies power to many devices, a voltage will develop over the length of wire. For example, a 1000 ft. of 18 AWG copper wire has a resistance of 6.4 Ohms. If this wire is supplying 1 Ampere of current to connected devices (See [Figure 88](#)), the voltage developed across it will be 6.4 volts. This effect is called ground lift.

Figure 88: Ground Lift from a Long Power Run with a 24VAC Device

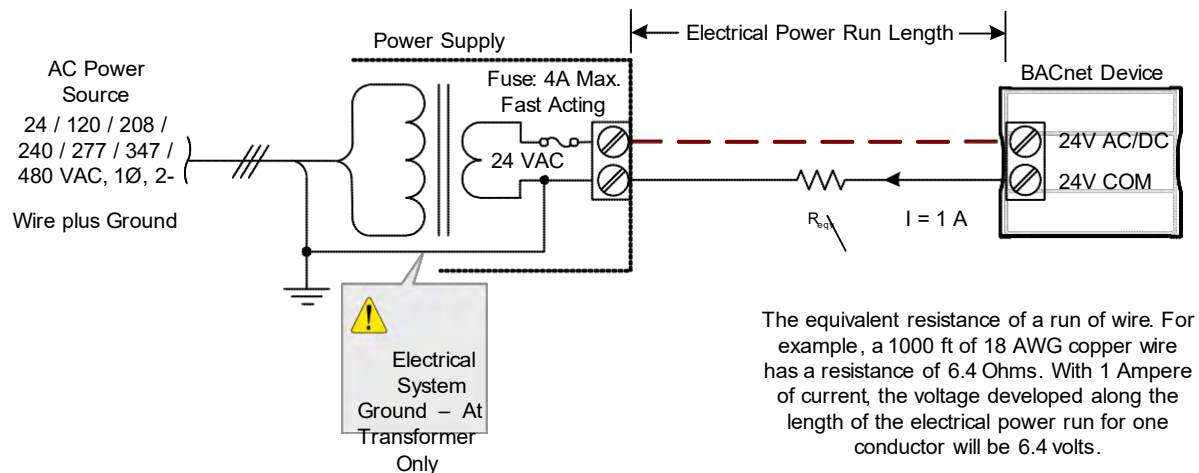

Because the 24V COM terminal on ECB series controllers is the signal reference point for the data bus, ground lift offsets the data bus voltage reference that is used to interpret valid data levels sent on the data bus. If the ground lift is more than 7 volts peak, there is a risk of data corruption and offline events due to the device being incapable of correctly reading data signals from the data bus. **Thus it is important to keep the power supply (transformer) as close to the controller as possible.**

Techniques to Reduce Ground Lift

Reduce the impact of ground lift as follows:

- Use a heavier gauge wire.
- Add more wire runs. Connect these wire runs to the power supply in a star pattern.
- For controllers that accept DC power (that is, models without triac outputs): Specify a 24VDC power supply. The continuous and even voltage of a DC power supply makes more efficient use of the power handling capabilities of a power run. A 24VDC power supply eliminates the 2.5 multiplication factor associated with the peak AC current being 2.5 times the average RMS AC current. See below.

About External Loads

When calculating a controller's power consumption to size the 24VAC transformer, you must also add the external loads the controller is going to supply, including the power consumption of any connected subnet module (for example, for Allure series communicating sensors). Refer to the respective module's datasheet for related power consumption information.

A controller can support a maximum of two Allure series sensor models equipped with a CO₂ sensor. See [Subnetwork Module Compatibility and Supported Quantity Charts](#) for how many Allure series communicating sensors are supported by a given controller model. The remaining connected Allure series sensor models must be without a CO₂ sensor.

24VAC Power Supply Connection

Use an external fuse on the 24VAC side (secondary side) of the transformer, as shown in [Figure 89](#), to protect all controllers against power line spikes.

The ECLYPSE Controller uses the **S** terminal as the signal reference point for the data bus (see [Table 4](#) for common device terminal labels).

CHAPTER 11

Resetting or Rebooting the Controller

This chapter describes how to recover control over the controller by resetting it to the factory default settings.

Topics

[*Resetting or Rebooting the Controller*](#)

Resetting or Rebooting the Controller

The reset button is located between the RS-458 and Ethernet connectors on connected system controllers and underneath the cover on connected VAV controllers. Depending on the amount of time the reset button is held down, different actions are taken by the controller.

Hold reset for	To
5 seconds	Restart / reboot the controller.
10 seconds	Reset both Ethernet and Wi-Fi IP addresses back to factory default settings.
20 seconds	Reset the controller to its factory default settings. User accounts (user names and passwords) will also be reset to the factory default settings and the controller's license and HTTPS security certificates will be cleared. If FIPS 140-2 mode has been enabled on the controller, this will turn FIPS 140-2 mode off.



Always backup the controller's license through the controller's Web interface before you hold the controller's reset button for 20 seconds. Once the controller reboots, you will have to install the license through the controller's Web interface.

To backup and install the license, see [System Settings](#). Click **Export To PC** to backup the controller's license to your PC. Click **Import From PC** to restore the controller's license file from your PC.

After you hold the controller's reset button for 20 seconds, the controller's HTTPS security certificates will be regenerated. If you use HTTPS to connect to the controller, you will no longer be able to connect to the controller from any PC that was used in the past to connect to the controller unless you delete the old HTTPS security certificate from these PCs. See [Removing a Certificate](#).

CHAPTER 16

NECY CONTROLLER TROUBLESHOOTING

You can use this Troubleshooting Guide to help detect and correct issues with the nLight ECLYPSE Series controllers.

Table 27: Troubleshooting NECY Controller Symptoms

Symptom	Possible Cause	Solution
Controller is powered but does not turn on	Fuse has blown (for 24V controllers)	Disconnect the power. Check the fuse integrity. Reconnect the power.
	Power supply polarity	Verify that consistent polarity is maintained between all controllers and the transformer. Ensure that the COM terminal of each controller is connected to the same terminal on the secondary side of the transformer. See DHCP versus Manual Network Settings
	The device does not have power / poor-quality power (for 24V controllers)	Verify that the transformer used is powerful enough to supply all controllers. See Transformer Selection and Determining the Maximum Power Run Length

Table 27: Troubleshooting NECY Controller Symptoms

Symptom	Possible Cause	Solution
Device does not communicate on the BACnet MS/TP network	Absent or incorrect supply voltage (for 24V controllers)	1. Check power supply voltage between 24VAC/DC and 24V COM pins and ensure that it is within acceptable limits ($\pm 15\%$ for 24V controllers). 2. Check for tripped fuse or circuit breaker.
	Overloaded power transformer (for 24V controllers)	Verify that the transformer used is powerful enough to supply all controllers. See Transformer Selection and Determining the Maximum Power Run Length
	Network not wired properly	Double check that the wire connections are correct.
	Absent or incorrect network termination	Check the network termination(s).
	Max Master parameter	Configure the Max Master to the highest MAC Address of any device on the MS/TP data bus. See Setting the Max Master and Max Info Frames
	There is another controller with the same MAC Address on the BACnet MS/TP data bus	Each controller on a BACnet MS/TP data bus must have a unique MAC Address. Look at the MAC Address DIP switch on the faceplate of each controller. If it is set to 0 (all off), use an Allure EC-Smart-Vue sensor to check the MAC Address.
	There is another controller with the same Device ID on the BACnet intranetwork	Each controller on a BACnet intranetwork (the entire BACnet BAS network) must have a unique Device ID. Use an Allure series communicating sensor to check the Device ID of each controller. See Adopting a Numbering System for MAC Addresses, Device Instance Numbers, and Network Numbers
	BACnet data bus polarity is reversed.	Ensure the polarity of the BACnet data bus is always the same on all devices. See BACnet MS/TP data bus is polarity sensitive
	Cut or broken wire.	Isolate the location of the break and pull a new cable.
	The BACnet data bus has one or more devices with the same MAC Address.	See Adopting a Numbering System for MAC Addresses, Device Instance Numbers, and Network Numbers
	The baud rate for all devices are set to AUTO	At least one device must be set to a baud rate, usually the data bus master. See Baud Rate
	The device is set to a MAC Address in the range of 128 to 255.	See if the STATUS LED on the device is showing a fault condition. See Table 28 for a list of fault codes. This range is for slave devices that cannot initiate communication. All Distech Controls' devices are master devices and must their MAC Address set accordingly. See Device Addressing
	The maximum number of devices on a data bus segment has been exceeded.	Use a repeater to extend the BACnet data bus. See Maximum Number of BACnet MS/TP Devices on a Data Bus Segment and Baud Rate
The STATUS LED is blinking	The device has auto-diagnosed a fault condition See Table 28 for a list of fault codes.	

Table 27: Troubleshooting NECY Controller Symptoms

Symptom	Possible Cause	Solution
Controller communicates well over a short network BACnet MS/TP network, but does not communicate on large network	Network length	Check that the total wire length does not exceed the specifications of the Network Guide. See Data Bus Physical Specifications and Cable Requirements
	Wire type	Check that the wire type agrees with the specification of the Network Guide: See Data Bus Physical Specifications and Cable Requirements
	Network wiring problem	Double check that the wire connections are correct.
	Absent or incorrect network termination	Check the network termination(s). Incorrect or broken termination(s) will make the communication integrity dependent upon a controller's position on the network.
	Number of controllers on network segment exceeded	The number of controllers on a channel should never exceed 50. Use a router or a repeater: See Data Bus Segment MAC Address Range for BACnet MS/TP Devices
	Max Master parameter	Configure the maximum number of master device on the MS/TP network in all devices to the controller's highest MAC address used on the MS/TP trunk. BACnet MS/TP Data Bus Token-Passing Overview .
Hardware input is not reading the correct value	Input wiring problem	Check that the wiring is correct according to the module's hardware installation manual and according to the peripheral device's manufacturer recommendations.
	Open circuit or short circuit	Using a voltmeter, check the voltage on the input terminal. For example, for a digital input, a short circuit shows approximately 0V and an open circuit shows approximately 5V. Correct wiring if at fault.
	Configuration problem	Using the controller configuration wizard, check the configuration of the input. Refer to the controller's user guide for more information.
	Over-voltage or over-current at an input	An over-voltage or over-current at one input can affect the reading of other inputs. Respect the allowed voltage / current range limits of all inputs. Consult the appropriate datasheet for controller input range limits.
Hardware output is not operating correctly	Fuse has blown (Auto reset fuse, for 24V controllers)	Disconnect the power and outputs terminals. Then wait a few seconds to allow the auto-reset fuse to cool down. Check the power supply and the output wiring. Reconnect the power.
	Output wiring problem	Check that the wiring is correct according to the module's hardware installation manual and according to the peripheral device's manufacturer.
	Configuration problem	With EC-gfxProgram, check the configuration of the output; for example, is it enabled? Refer to the EC-gfxProgram User Guide for more information.
	0-10V output, 24VAC powered actuator is not moving	Check the polarity of the 24VAC power supply connected to the actuator while connected to the controller. Reverse the 24VAC wire if necessary.

Table 28: LED Fault Condition Interpretation for ECB Devices

ECB Device LED Interpretation	Description	Solution
RX LED not blinking	Data is not being received from the BACnet MS/TP data bus.	If there is no communication, see Table 27 - Troubleshooting NECY Controller Symptoms.
TX LED not blinking	Data is not being transmitted onto the BACnet MS/TP data bus.	
POWER constant on	Power is available at the device. However this does not mean that the quality of supplied power is good. See Power Supply Requirements for 24VAC-Powered Controllers .	If not lit, see Power Supply Requirements for 24VAC-Powered Controllers for the power requirements.
STATUS blinking	See following table.	-

Table 29: STATUS LED Interpretation for Normal Operation with ECB Devices

Device STATUS LED blink patterns	Status	Description
One fast blink ●	Initialization	The device is starting up.
The STATUS LED is always OFF (Not applicable to ECB-PTU Series)	No anomaly	Normal operation.

Table 30: Verify that the Following Recommendations have been Carried Out Before Calling Technical Support

Properly terminate the BACnet MS/TP data bus	EOL terminations must be enabled / installed at either end of the data bus only. See Figure 71 .
Avoid duplicate MAC Addresses	Verify that no device has a duplicate MAC Address by checking the MAC Address DIP switch settings on all devices on the data bus, including segments connected by a repeater. If necessary, isolate devices from the data bus to narrow-down the number of devices that may be at fault.

Table 30: Verify that the Following Recommendations have been Carried Out Before Calling Technical Support

All devices must be set to the same baud rate	When all devices are set to AUTO baud rate, at least one device must be set to a baud rate, usually the data bus master. See Maximum Number of BACnet MS/TP Devices on a Data Bus Segment and Baud Rate
The data bus is polarity sensitive	Ensure that the polarity of all data bus wiring is consistent throughout the network. See BACnet MS/TP data bus is polarity sensitive
Do not overload the data bus with Change of Value (COV) reporting	COV reports create the most traffic on the BACnet MS/TP data bus. Set the COV report rate to the largest value that provides acceptable performance. Only map COV reports for values that are necessary. For mapped analog points that are continuously changing, try increasing the COV increment on these points or set the COV minimum send time flag to true to send the value at a regular frequency.
Do not leave address holes in the device's MAC Address range	Assign MAC Address to device starting at 3, up to 127. Do not skip addresses. Set the maximum MAC Address in the NECY Series Controller to the final MAC Address number actually installed. NOTE: The physical sequence of the MAC Address of the devices on the data bus is unimportant: For example, the MAC Address of devices on the data bus can be 5, 7, 3, 4, 6, and 8.
Only daisy-chained devices are acceptable	Eliminate T-taps and star configurations. Use a router to connect a data bus spur.
Connect no more than five devices to a power supply transformer (for 24V controllers)	BACnet MS/TP devices require good power quality. See Power Supply Requirements for 24VAC-Powered Controllers

CHAPTER 18

WI-FI NETWORK TROUBLESHOOTING GUIDE

Any wireless system consists of two or more Wi-Fi transceivers and a radio propagation path (Radio Path). Problems encountered can be any of the following.

Symptoms	Probable Causes	Corrective Actions
Wi-Fi communications are inconsistent or intermittent	Presence of a low power jammer	If the low power jammer is close to the transceiver antenna, move low power jammer (PC, telephone, etc.) at least 6.5 feet (2 m) away from transceiver antenna.
		Change the Wi-Fi channel on the router. Use a Wi-Fi surveying or Wi-Fi stumbling tool on a laptop computer to identify unused Wi-Fi channels that may provide a better interference-free radio path.
		Move the nLight ECLYPSE Wi-Fi Adapter's position where it has a clear line of sight to the router.
		Move the wireless router's position. Try moving the router to the center of the room where it has a clear line of site to each wireless device.
	Presence of a high power jammer	Remove high power jammer if possible. If not, you will have to accept strong range reduction or add another wireless router closer to the controller(s).
		Use a wired Ethernet connection to the controller.
Defective nLight ECLYPSE Wi-Fi Adapter	Exchange the wireless dongle with another nLight ECLYPSE Wi-Fi Adapter. If the dongle is found to be defective, replace the dongle.	
The maximum wireless operating range has been exceeded	Add another wireless router closer to the controller(s).	
The controller has a known technical issue	Upgrade the controller's firmware. See User Management	
The nLight ECLYPSE Wi-Fi Adapter has been tested functional and there is no jammer in the field to interfere with the signal.	Radio signal path might be obstructed	If a new screening or metal separation wall has been installed since the network was set up, try moving the receiver to see if the issue is corrected.
	Router may have a known technical issue	Upgrade the router's firmware. See the manufacturer's Website.

Document Revision History

1. Version 0.1 - December 2014 - Beta Release
2. Version 1.0 - January 2015 - Release to Market
3. Version 1.1 - February 2015 - Updated Web Interface Information
4. Version 1.2 - September 2015 - Added the NECY-VAV series controllers, BACnet MS/TP, Modbus RTU, and Modbus TCP network support
5. Version 1.3 - October 2015 - Added Wi-Fi Mesh and Smart Room Control support
6. Version 1.4 - December 2015 - Clarified the number of Allure EC-Smart-Air and Allure EC-Smart- Comfort that are supported by a given controller model.
7. Version 1.5 - May 2016 - Added information for the ECx-Display
8. Version 1.6 - October 2016 - Minor updates
9. Version 1.7 - March 2017:
 - New Applications tile in Web Configuration Interface
 - Update password information when FIPS 140-2 is enabled.
 - XpressNetwork Companion mobile app support
 - Updated Foreign Device Settings
10. Version 1.8 - June 2017 - Removed Wi-Fi mesh, added GSA support, new screenshots for the nLight ECLYPSE Web Interface, new backup & restore feature.

SensorView Installation Guide

Step 1

SENSORVIEW REQUIREMENTS

Depending on the intended usage of SensorView, there are two sets of computer hardware/software requirements.

- Single-user / Commissioning Installation: Recommend Windows 7 or Newer
- Multi-user Installation: Recommend Windows Server 2012 or Newer

Hardware Minimum Operating Specs:

- Ram: 2GB (4GB Recommended)
- Hard Drive: 20GB
- Browser: Firefox, Chrome, Opera, IE 10+

Versions of Windows supported (both 32 and 64 bit versions supported):

- Client Versions: 7, 8.1, 10
- Server Versions: 2012 (R2), 2016

Note: Virtual machine operation supported

Step 2

PRE-INSTALLATION

The following Windows software components are required prior to SensorView installation:

- .NET Framework
 - Available for download (free) from Windows Updates web page
- IIS (Internet Information Services):
 - IIS 7.0 Windows

NOTE: If .NET/IIS are not installed prior to running the SensorView installer, user will be automatically prompted to install these items during SensorView installation.

Step 3

SENSORVIEW INSTALLATION

The SensorView application installer is downloaded from the Acuity Brands website:

- <http://www.acuitybrands.com/-/media/Software%20Downloads/nLight/SensorViewInstallerv612%20zip.zip?la=en>

NOTE: Internet access is required during installation to download latest available version of the SensorView software.

Step 4

CONNECTION TO GATEWAY

The Gateway uses its port labeled "LAN" to communicate with the computer running the SensorView software.

- Please reference "SensorView User Manual" for details on methods to connect to a system Gateway.

If assistance is required, please contact our technical support team at 800-535-2465 or nLight-Support@AcuityBrands.com.

Using SensorView

SensorView provides a large variety of configuration options to fine tune the connected nLight network. This section covers common configuration and management tasks that arise when setting up and maintaining the network over time; as well as step by step instructions for accomplishing a given task.

The Device Tree: The Device Tree is the foundation for navigating through SensorView and easily locating a specific device, profile, etc. It is always located in the far left side of the screen, and works in the same fashion as standard collapsing menus do in other programs. Select which feature of the Device Tree you wish to learn more about

- [Device Tree Overview](#)
- [Tree Layout](#)
- [Search / Filter / Locate Device](#)
- [View Device State](#)
- [View Device Status](#)
- [Selecting Multiple Devices](#)

FloorPlan: A feature providing a visual layout of the space for the purposes of device and zone selection and interaction. [Contact us](#) to have a layout produced for your nLight installation.

Once a layout is produced and you have received the layout (.mvdb) file, it can be imported into SensorView by going to Admin > Map and clicking the “Import” button, then browsing to and selecting the file.

Software and Firmware Updates

- **Updating Sensorview:** This process walks you through upgrading to the latest version of SensorView, and ensures you are running on the latest build, including the newest patches, compatibility fixes, and features. This process can only be run by authorized administrators of SensorView's host machine, they cannot be performed via the web interface.
- **Updating Device Firmware:** Each nLight device has internal software that can be updated, usually to add new functionality. This process will ensure your devices are all running on up-to-date firmware, and can only be performed by authorized nLight network administrators.

Common Procedures: The menu items on the left are the procedures most commonly asked about using SensorView. If a procedure you are trying to perform is not included in this list, please contact us at tech@sensorswitch.com and we will look into adding it for future revisions.

- [Logging in](#)
- [Administrative Tasks](#)
 - [Creating Users](#)
 - [Modifying Users](#)
 - [Gateway Page](#)
 - [Location Page](#)
- [View Device Properties](#)
- [Viewing / Editing Device Settings](#)
 - [Normal Devices](#)
 - [Scene Selectors / nIOs](#)

- [Viewing / Editing Zone Settings](#)
- [Managing Profiles](#)
 - [Create a Profile](#)
 - [Edit a Profile](#)
 - [On Demand Profiles](#)
 - [Delete a Profile](#)
- [View Reports](#)
- [Upgrading Devices](#)

[SensorView](#)

- [Step 1: Requirements](#)
- [Step 2: Pre-Installation](#)
- [Step 3: Installation](#)
- [Step 4: Connecting to Gateway](#)

[Virtual Wallpods](#)

- [Configuring SensorView](#)
 - [Update SensorView](#)
 - [Virtual Wallpod Server](#)
 - [Virtual Controls](#)
 - [Virtual WallPod Switch](#)
 - [Control Zone](#)
- [Virtual WallPod Application](#)
- [iOS App](#)

[GreenScreen](#)

- [Setting up PostgreSQL](#)
- [Setting up Database Connection](#)
- [Setting up GreenScreen](#)

[SensorView Page Mapping](#)

[Overview](#)

[Log\[DA1\]](#)

[Green Screen](#)

Admin: The Admin tabs are for administrators only, and will not be accessed by a day to day end user.

- [Setup](#)
- [Updates](#)
- [Databases](#)
- [Plugins](#)
- [Reports](#)

Navigation Tabs: Across the top of all pages within SensorView are the **Navigation Tabs**. Depending on a user's permissions only some of these may be available. To learn more about each tab, click from the list below:

- [Devices](#)
- [Control Channels](#)
 - [Local Channels](#)
 - [Global Channels](#)
- [Group Settings](#)
- [Profiles](#)
- [Schedules](#)
- [Users](#)

Glossaries

- [SensorView Terms](#)
- [Status Icons](#)

Device Tree Overview

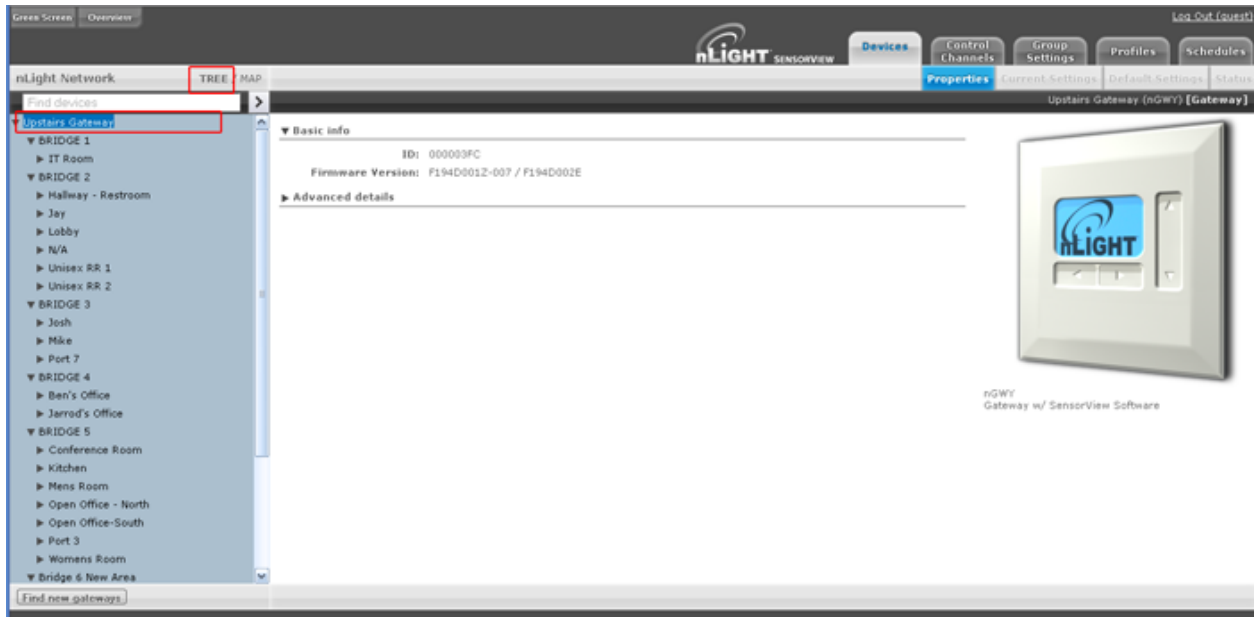

The Device Tree Menu, available from the arrow to the right of the search textbox, contains selection features that aid in the location / selection of devices. Three primary types of search features exist: Features, Profiles, and Device States. Features allows for selecting / searching of the tree based on predefined characteristics of the device, such as whether it has a relay or occupancy sensor; available options are: current-sensing, occupancy, daylighting, relay, dimming, switch, dimming-or-relay.

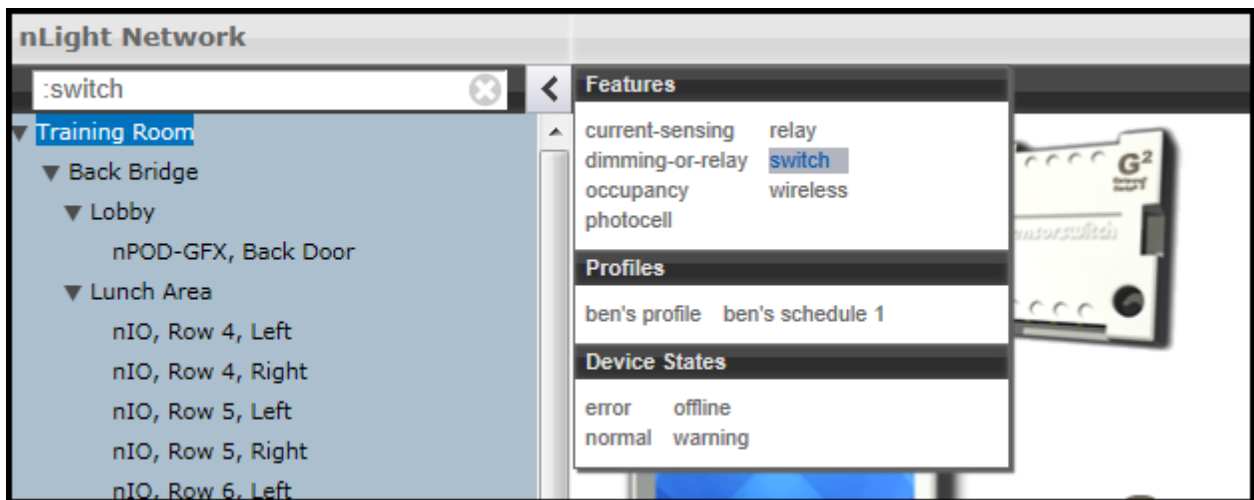

Profiles locates or selects devices that are in a particular profile; this is useful when creating a new profile that operates on all the devices already in an existing profile. As profiles are added or removed from the system the contents of this selections will change. [Device States](#) allows for searching or selecting devices depending on their current state.

Tree Layout

The layout of the SensorView device tree corresponds closely with the actual wiring of the devices, with a few notable exceptions:

Bridges are not nested within their parents



Zones off a bridge are displayed in ascending alphabetical order

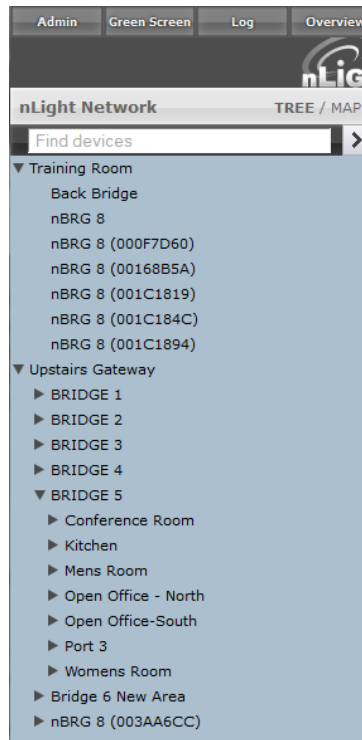

Devices in a zone are displayed in alphabetical order, not wiring order

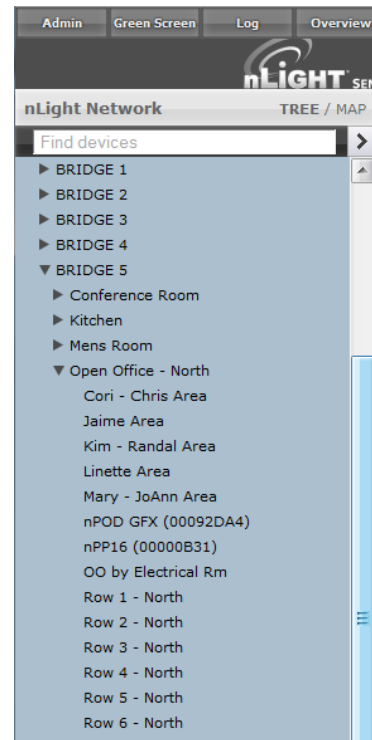

Search / Filter / Locate Device

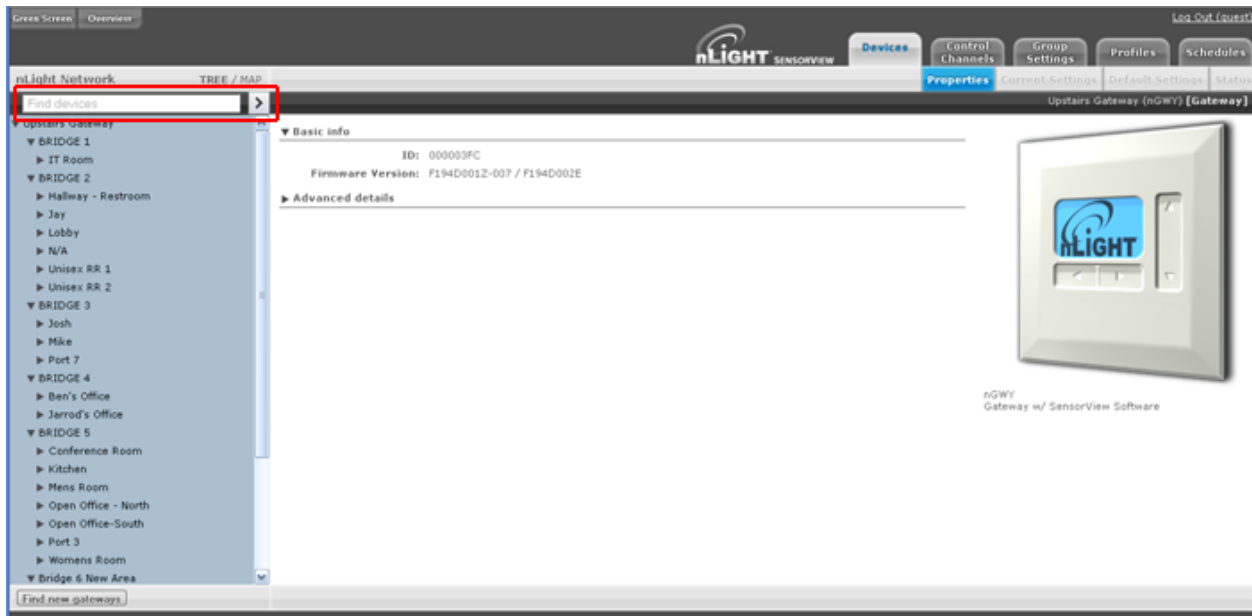

The SensorView tree allows for the user to **select or search for devices** based on a variety of parameters. The Device Tree Menu contains numerous options for searching for (“finding”) devices based on predetermined characteristics (such as device state, or features the device has). The text field above the device tree also allows for **free text search over the devices**. A user can type any value into the field and the tree will automatically begin filtering to display devices with label(s), model(s), or device ID(s) matching the entered value(s).

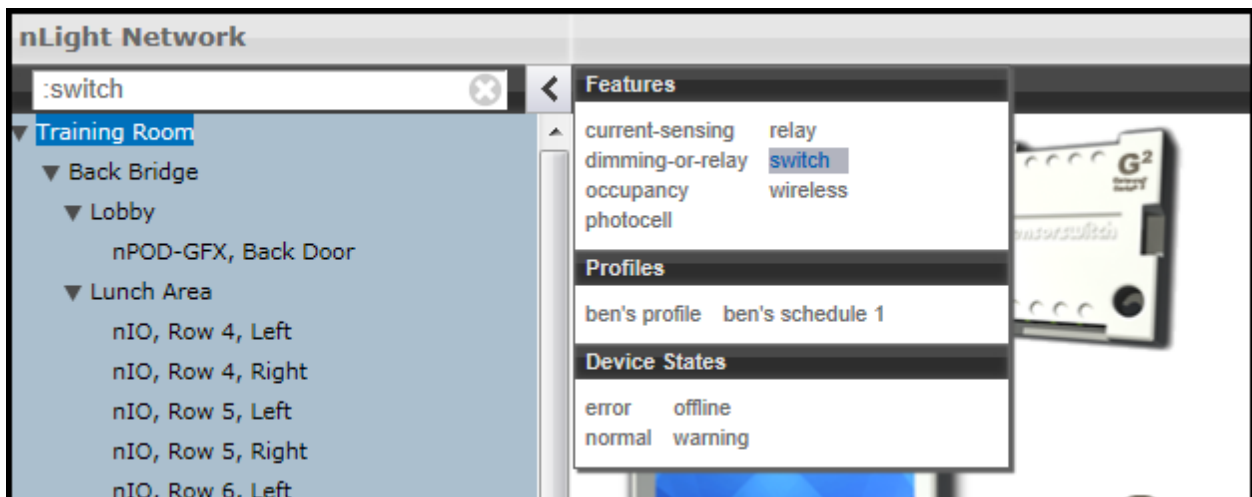

There are two primary ways to quickly locate a device: use the device **Search**, or the **prebuiltFeatures**.

1. **Device search (filter)** allows a user to immediately begin typing to search for the device (over device ID, model, or custom label), while
2. **Features** allows for a user to search for a device based on its
 - Hardware capabilities:
 - current-sensing, dimming-or-relay, occupancy, photocell, relay, switch, wireless
 - Profiles
 - Select by Profile name
 - Device state
 - error, normal, offline, warning

Note that any device matched and displayed will automatically cause the parent zone, bridge, and gateway to be displayed. When operating in MultiSelect ([link](#)) mode, clicking on the parent nodes will select all the currently visible child nodes, and will omit the ones that have been filtered out.

View Device State

For any device selected from the Device Tree (left), SensorView displays data in real time by selecting one of the available tabs: **Properties**, **Current Settings**, **Default Settings**, and **Status**. This example shows the readings from one of the nLight Ceiling-Mount, Passive Dual-Technology sensors covering approximately an area of 9 meters in diameter (nCM PDT 9) in the Zone called “Mike”, which has been selected from the device tree menu.

The screenshot displays the nLight SensorView web interface. On the left is a 'Device Tree' showing a hierarchy of zones and devices. The 'Mike' zone is expanded, and 'nCM PDT 9 (00000D45)' is selected. The main area shows the 'Properties' tab for this device. At the top, there are navigation tabs: 'Overview', 'Devices', 'Control Channels', 'Group Settings', 'Profiles', and 'Schedules'. Below these are sub-tabs: 'Properties', 'Current Settings', 'Default Settings', and 'Status'. The main content area features a large 3D rendering of the nCM PDT 9 sensor. Below the rendering, the device name and description are shown: 'nCM PDT 9 Standard Range 360° Sensor - Ceiling Mount, Low Voltage, Dual Technology (PDT)'. Two sections follow: 'Basic info' and 'Advanced details'. The 'Basic info' section lists 'Device ID: 00000D45' and 'Firmware Version: F183E0042-003 / B183E002E'. The 'Advanced details' section lists 'Date Code: 3908', 'Zone: Mike (on BRIDGE 3)', 'Network Depth: 3', 'BACnet Instance: 291', and 'Associated Profile: Mike's Office'. A 'Log Out (quest)' link is visible in the top right corner.

There are 6 possible states that an nLight device can be in. These different generally indicate some sort of operational problem with a device.

Note: “Device State” (shown below) is not the same as [Device Status](#). Individual device types can have various “status” conditions, depending on their functions.

- **Offline** – The device is no longer online, check that the device is properly connected

- **Out of Range** – The device is online, but communication is restricted due to insufficient signal strength. This applies to **nWiFi** devices only. Signal strength for wireless may vary under certain conditions. Devices downstream from an **nWiFi** device may also appear Out of Range, if the parent is.
- **Bootstrap** – The device failed a firmware update and is in bootloader. Any relay or dimming output will be toggled on, but the device will not respond to any operational changes. [Update the device](#) to resolve this.
- **Misread** – Some properties of the device were not read by the gateway. To resolve state, go to the device and select “Rediscover” or use Group Select->Rediscover
- **Incompatible** – SensorView is not compatible with this device and is unable to configure it. [Upgrade the device](#) to resolve this.
- **Mismatched** – SensorView has detected that the devices’ settings do not match what is expected. Synchronize the device (either using SensorView or device’s settings) to resolve.

View Device Status

The **Status Screen** displays the present state of any device selected in the left tree menu. Device types have different functions. The status pages display parameters specific to the type of device selected, indicated by icons easily seen at glance.

The screenshot shows the nLight SensorView interface. On the left is a tree view of the network structure, with 'nPP16 (00000B21)' selected under 'Upstairs Gateway' > 'BRIDGE 1' > 'IT Room'. The main panel displays the status for this device, organized into several sections:

- Occupancy, Relay & Dimming:** Shows 'Occupied: No' with a person icon and 'State: Open' with a switch icon. Below it, 'Pole State Reason: Zone Unoccupied' is shown with a person icon.
- PIR & PDT:** Shows 'Tracked Occupancy Timer: 00:00:00' with a clock icon.
- Scenes & Profiles:** Shows 'Scene Active: No' with a clapperboard icon and 'Profile Active: No' with a clock icon.
- Broadcasting & Tracking Channels:** Shows 'Tracking Occupancy on channel: 1' with a person icon, 'Tracking Photocell on channel: 1' with a sun icon, and 'Tracking Switch on channel: 1' with a switch icon.
- Voltage:** Shows 'Port 1: 21' and 'Port 2: 21' with lightning bolt icons.
- Temperature:** Shows 'Temperature: 20°C / 68°F' with a thermometer icon.

The current state of the device for each parameter (icon) is also displayed in readable text, which may include additional information on the particular status of the parameter within the selected device.

For a complete guide to Status Icons or possible conditions for a given device parameter, visit the [Status Icon Glossary](#).

Selecting Multiple Devices

In certain contexts the Device Tree will allow for users to select multiple devices, rather than just one. This mode of selection is available on **Group Settings, Profiles, Global Channels, or Users**. This mode of selection greatly enhances the ability to quickly create system schedules, permissions, or make wholesale changes to device settings.

To select multiple devices:

- Check multiple boxes, each new device will be added to the selection. Checking a selected device a second time will remove it from the grouping.
- Check a Zone / Bridge / Gateway to select all of the devices within that group. Check that grouping structure a second time to deselect all devices within that Zone / Bridge / Gateway group.

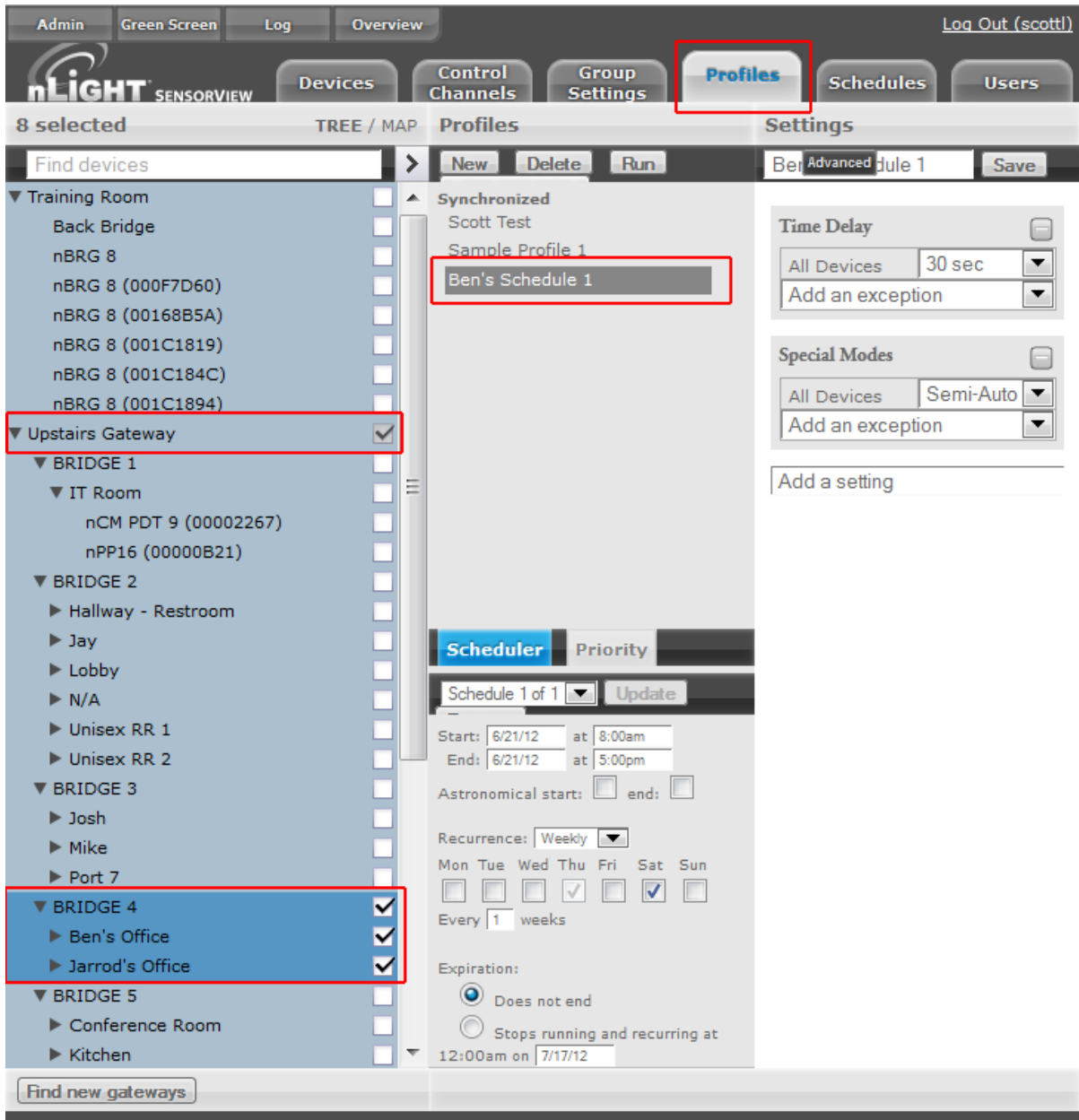

Selecting multiple devices is useful when large amounts of devices are to be operated on simultaneously. **Profiles, Users, Group Settings** and **Global Channels** all support multiple device selection. All other modes operate in single select, such that selecting any item in the tree displays information specific to that device.

SensorView Manual

**None Selected
(empty Checkboxes)**

**Bridge Selected
(Parent gateway
checked in gray)**

**Zone expanded.
All zone devices checked**

**Specific zone devices
unchecked**

The image displays four screenshots of the nLight Network interface, each showing a different selection state. Each screenshot has a title above it and a corresponding window below it. The windows show a tree view of the network structure with checkboxes next to each item.

- None Selected (empty Checkboxes):** The window title is "nLight Network". The tree view shows a hierarchy starting with "Training Room", followed by "Back Bridge", "Upstairs Gateway", and five "BRIDGE" entries (BRIDGE 1-5). Each item has an unchecked checkbox.
- Bridge Selected (Parent gateway checked in gray):** The window title is "13 selected". The "Upstairs Gateway" item is checked and highlighted in gray. Its sub-items, including "BRIDGE 3", are also checked and highlighted in gray.
- Zone expanded. All zone devices checked:** The window title is "13 selected". The "Upstairs Gateway" is checked and gray. The "BRIDGE 3" item is expanded, and all its sub-items (Josh, Mike, Port 7, nIO, nPODM DX WH, nPP16, Occ Sensor) are checked and highlighted in blue.
- Specific zone devices unchecked:** The window title is "10 selected". The "Upstairs Gateway" is checked and gray. The "BRIDGE 3" item is expanded, but only "Josh", "Mike", and "Port 7" are checked and highlighted in blue. The other sub-items (nIO, nPODM DX WH, nPP16, Occ Sensor) are unchecked.

Updating SensorView

Please note that the following procedure *must* be done from the SensorView host computer, and cannot be initiated over the web; administrator credentials on the host are also required.

Note: Always retrieve the latest installer to perform the actual update, on occasion SensorView updates will require subsequent device updates, should this occur the installer will warn you before proceeding with the update.

Depending on the currently installed version of SensorView the steps to update the software may vary, for all versions less than 7.0, follow steps **A** and **B**. Otherwise, proceed to step **B**.

A. Updating to 6.14:

1. Visit **Updates** page in SensorView & initiate upgrade to 6.12.xx:



2. Return to the **Updates** page & initiate upgrade to 6.14.xx.
3. Return to **Updates** page & run all available updates on firmware:



4. Return to **Updates** page & follow instructions to update to 7.x.x:



B. Updating to the latest version:

1. [Download SensorView installer](#) [DA2] and run *Setup.exe*
2. Select **Modify** when offered and follow the prompts.

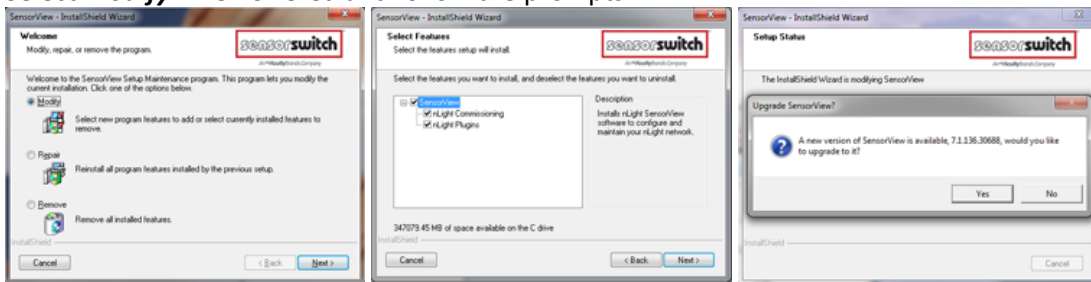

3. Return to **Updates** page & run all available firmware updates.

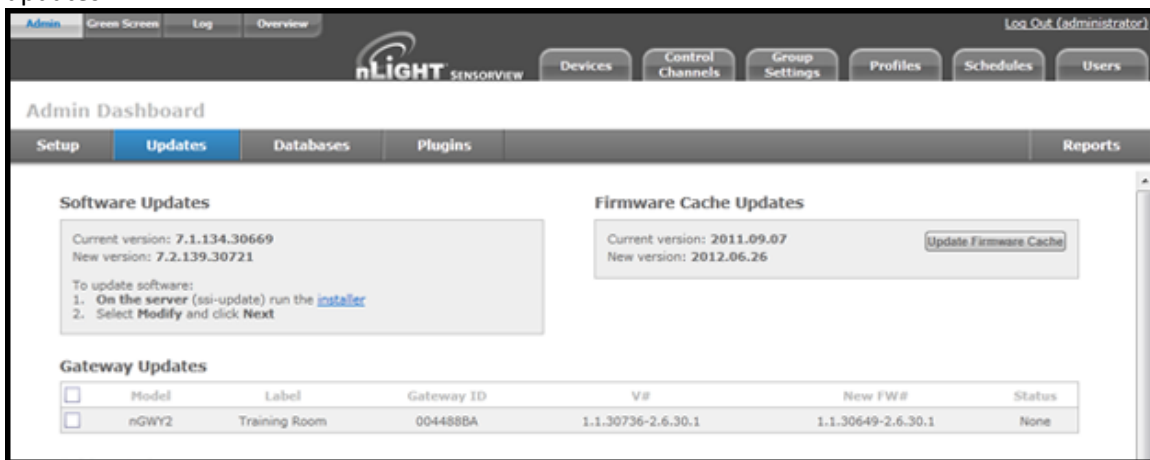

Downgrading to Version 6.12.x

If you need to return to SensorView Version 6.12 for any reason, run the [6.12.x installer](#). Note that you will have to uninstall the current version of SensorView beforehand.

Updating Device Firmware

Select the **Admin** button at upper left, then select the **Updates** tab to view all available updates. Devices will be omitted from the listing if they are currently up to date.

SensorView will retrieve the latest firmware for each device from the internet. If you are not going to have internet then download and install the firmware cache (top right), which will allow firmware updates to be performed offline.

Admin Dashboard

Log Out (administrator)

Devices Control Channels Group Settings

Setup **Updates** Databases Reports

Software Updates

Current version: 7.1.136.30688
New version: 7.2.141.30796

To update software:
1. Run the [installer](#)
2. Select **Modify** and click Next

Firmware Cache Updates

Current version: 2012.06.26
firmware cache is up-to-date

Sensor Updates

<input checked="" type="checkbox"/>	Model	Label	ID	Gateway ID	V#	New FW#	Status
Ceiling Sensors							
<input checked="" type="checkbox"/>	nCM 9 ADC		0046052C	FFFFFFF0	Z-006-D	Z-009-E	Incompatible

WallPod Updates

<input type="checkbox"/>	Model	Label	ID	Gateway ID	V#	New FW#	Status
<input type="checkbox"/>	nPODM 2P DX WH		0045B831	FFFFFFF0	Y-E	Z-002-F	Incompatible

Power Pack Updates

<input type="checkbox"/>	Model	Label	ID	Gateway ID	V#	New FW#	Status
<input type="checkbox"/>	nPP16		003D8F3B	FFFFFFF0	Z-002-D	Z-004-E	Incompatible
<input type="checkbox"/>	nSP5 D		0045AA75	FFFFFFF0	Z-005-D	Z-008-E	Incompatible

Update Selected

The status of the update is displayed in the rightmost column of the blue Status bars, and also at the top center of the screen:

1. Status: **Pending** while “**Preparing to update firmware ...**”
2. Status: **In Progress** while “**Updating firmware: X% done**”
3. Status: **Completed Fast** when “**100% Done**”

While firmware is being updated by the system, the actual physical device will display a very fast blink of its green status light, as well as closing relays and dimming to full bright, as appropriate. As the process nears completion, the device will display a slow, blinking pattern. After a few minutes, the device status light will return to normal.

SensorView Manual

The screenshot shows the Admin Dashboard for nLight SensorView. At the top, there is a navigation bar with 'Admin', 'Log', and 'Overview' tabs. A green progress indicator shows '100% Done'. The dashboard is divided into sections for 'Software Updates', 'Firmware Cache Updates', 'Sensor Updates', 'WallPod Updates', and 'Power Pack Updates'. The 'Sensor Updates' table shows one device with a 'Completed Fast' status, while others are 'Incompatible'.

Software Updates
 Current version: 7.1.136.30688
 New version: 7.2.141.30796
 To update software:
 1. Run the [installer](#).
 2. Select **Modify** and click **Next**.

Firmware Cache Updates
 Current version: 2012.06.26
 firmware cache is up-to-date

Sensor Updates

<input type="checkbox"/>	Model	Label	ID	Gateway ID	V#	New FW#	Status
<input type="checkbox"/>	Ceiling Sensors						
<input type="checkbox"/>	nCM 9 ADC		0046D52C	FFFFFFF0	Z-009-E	Z-009-E	Completed Fast

WallPod Updates

<input type="checkbox"/>	Model	Label	ID	Gateway ID	V#	New FW#	Status
<input type="checkbox"/>	nPODM 2P DX WH		0045B831	FFFFFFF0	Y-E	Z-002-F	Incompatible

Power Pack Updates

<input type="checkbox"/>	Model	Label	ID	Gateway ID	V#	New FW#	Status
<input type="checkbox"/>	nPP16		003D8F3B	FFFFFFF0	Z-002-D	Z-004-E	Incompatible
<input type="checkbox"/>	nSP5 D		0045AA75	FFFFFFF0	Z-005-D	Z-008-E	Incompatible

Update Selected

Repeat this process for all devices by selecting any and all (at once) which require firmware updates.

When all devices have been updated, the red Incompatible conditions on the screen will be replaced by **Completed Fast**.

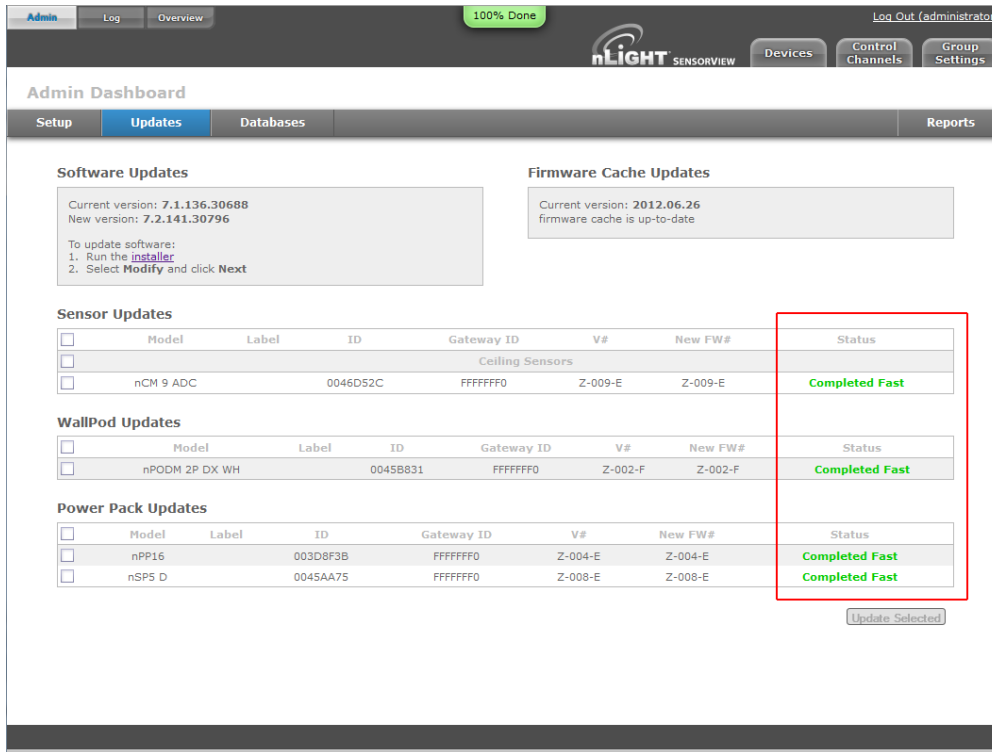

Logging in

Navigate to the SensorView login screen via the Start Menu, desktop shortcut, or by directly typing the address into the web browser (note: address requires entering the Host Specific Computer Name, which is installation specific):

http://<Host Computer Name>/SensorView



Enter your *case sensitive* username and password. Default login is:

Username: **administrator**

Password: **admin**

If you have forgotten or do not have your login information, please contact your network administrator.

Administrative Tasks

Only administrative users have authority to perform these tasks, which involve modifying / creating users, as well as modifying properties on the Gateway & Location pages.

Creating:

1. Click the **Users** tab



2. Select **Add a User** from the dropdown

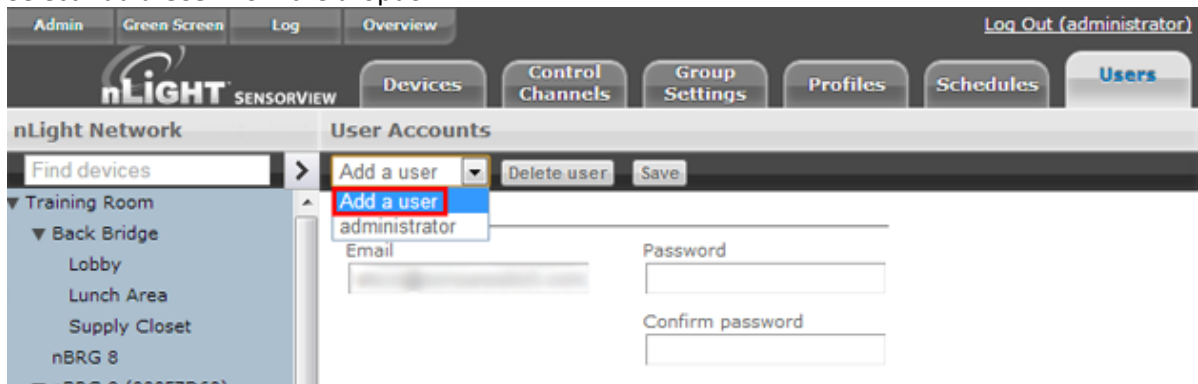

- Fill out all fields, making sure to set the appropriate access level.

User Accounts

Add a user | Delete user | Save

User details

Username:

Password:

Email:

Confirm password:

Type:

Virtual switches

Add Switch | Delete Switch

- Click **Save**

User Accounts

Add a user | Delete user | **Save**

User details

Username:

Password:

Email:

Confirm password:

Type:

Virtual switches

Add Switch | Delete Switch

New Switch

Switch label (optional):

Select zone:

Control type:

Modifying:

1. Click the **Users** tab



2. Select user from the dropdown

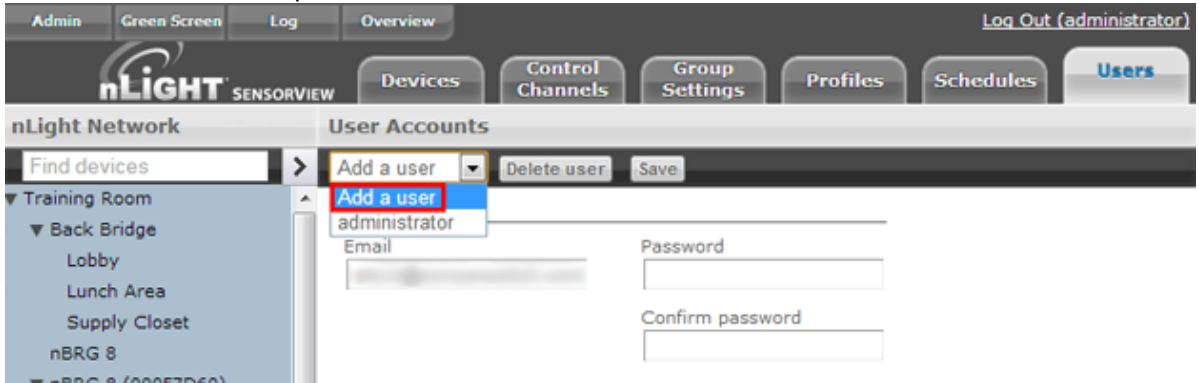

3. Change the appropriate information

The screenshot displays the 'User Accounts' interface in the nLight SensorView application. On the left, a navigation tree lists various rooms and devices, including 'Training Room', 'Back Bridge', and 'Upstairs Gateway'. The main panel shows the configuration for the 'administrator' user. Under the 'Virtual switches' section, a switch named 'Lobby C1' is configured with a dimmer type and assigned to the 'Lobby (Back Bridge)' zone. A list of associated devices is visible below the switch configuration.

4. Click **Save**

This close-up view of the 'User Accounts' page highlights the 'Save' button, which is enclosed in a red rectangular box. The 'administrator' user is selected in the dropdown menu, and the 'Delete user' button is also visible next to it.

Gateway Page

The Gateways tab allows operators to manage the nGWY devices that are currently managed by SensorView. nGWY devices running on the same IP Subnet will be discovered automatically by SensorView; any nGWYs that reside on different segments of the IP network can be added by simply entering their IP address on the Gateways tab.

Note: Discovering nGWY devices on different segments of the IP network may require for firewalls and routers to be updated to allow access to the [necessary ports](#).

Including / Excluding Gateways:

1. Click the **Admin** tab

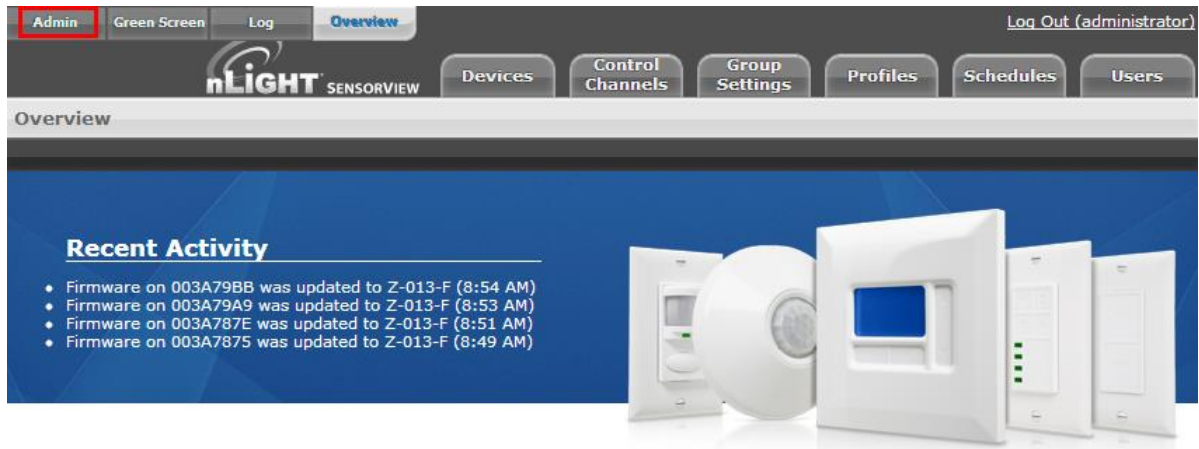

2. Click the **Gateways** section to expand it

Admin Dashboard

Setup	Updates	Databases	Plugins
-------	---------	-----------	---------

Location

<div style="border: 1px solid #ccc; padding: 2px; margin-bottom: 5px;"> SensorView Server Gateway 000003FC Gateway 004488BA </div> <div style="border: 1px solid #ccc; padding: 2px;"> Time Zone and DST as: America/New York </div>	<p>For sunrise/sunset (astronomical time offsets):</p> <p>Choose nearest location:</p> <p>Country: <input type="text" value="US"/></p> <p>State: <input type="text" value="Connecticut"/></p> <p>City: <input type="text" value="New Haven"/></p> <table style="width: 100%; border-collapse: collapse;"> <tr> <td style="text-align: center;">Latitude North (Degrees, Minutes)</td> <td style="text-align: center;">Longitude East (Degrees, Minutes)</td> </tr> <tr> <td style="text-align: center;"><input type="text" value="41"/> <input type="text" value="19"/></td> <td style="text-align: center;"><input type="text" value="-73"/> <input type="text" value="55"/></td> </tr> </table>	Latitude North (Degrees, Minutes)	Longitude East (Degrees, Minutes)	<input type="text" value="41"/> <input type="text" value="19"/>	<input type="text" value="-73"/> <input type="text" value="55"/>
Latitude North (Degrees, Minutes)	Longitude East (Degrees, Minutes)				
<input type="text" value="41"/> <input type="text" value="19"/>	<input type="text" value="-73"/> <input type="text" value="55"/>				

Gateway Password

Gateways

Mail Server

3. Make any changes to the existing list, such as whether or not to include a particular Gateway
Admin Dashboard

Setup
Updates
Databases
Plugins

Location

Gateway Password

Gateways

Gateway IP: Discover

Include	IP Address	Label	Status	
<input checked="" type="checkbox"/>	10.65.67.52	Upstairs Gateway	Online	Delete
<input checked="" type="checkbox"/>	10.65.67.102	Training Room	Online	Delete

Save

Mail Server

4. Add IP addresses of any required Gateways not auto-detected (requires IP address).
5. Click **Save** to apply your changes

Setup
Updates
Databases
Plugins

Location

Gateway Password

Gateways

Gateway IP: Discover

Include	IP Address	Label	Status	
<input checked="" type="checkbox"/>	10.65.67.52	Upstairs Gateway	Online	Delete
<input checked="" type="checkbox"/>	10.65.67.102	Training Room	Online	Delete

Save

Location Page

Properly configuring the location for all nGWY devices and the SensorView host is required to ensure that all profiles will run at the proper time. Setting the time zone allows the nGWY devices to properly update their time throughout the course of the year as Daylight Savings Time comes into effect. The location parameters allow the nGWY devices and SensorView to properly compute the correct Sunrise and Sunset times for a given day.

Viewing/Editing Gateway & Server Locations:

1. Click the **Admin** tab

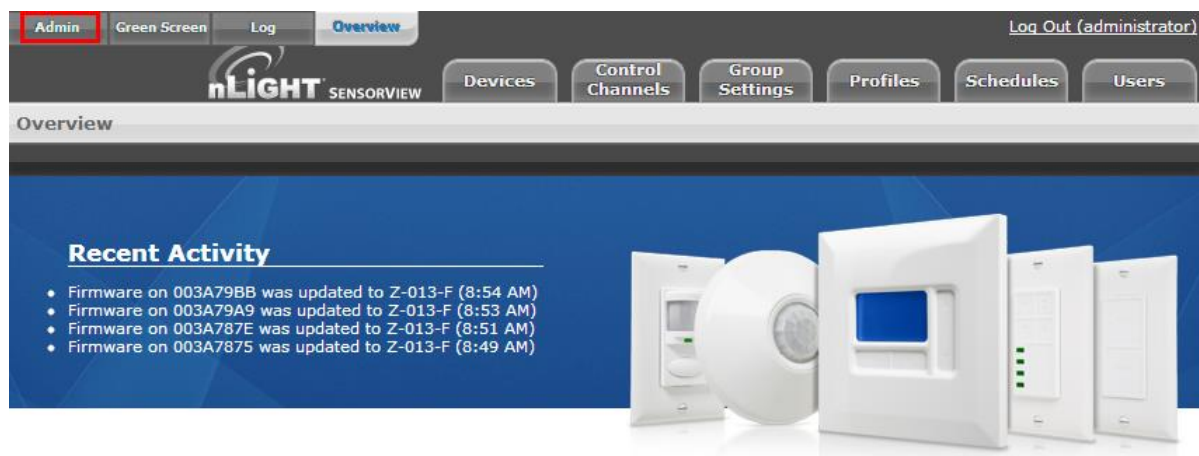

- The **Setup** tab should automatically load with the Location section expanded

Admin Dashboard

Setup Updates Databases Plugins

Location

SensorView Server
Gateway 000003FC
Gateway 004488BA

Time Zone and DST as:
America/New York

For sunrise/sunset (astronomical time offsets):
Choose nearest location:
Country: US
State: Connecticut
City: New Haven

Latitude North (Degrees, Minutes) Longitude East (Degrees, Minutes)
41 19 -73 55

Gateway Password

Gateways

Mail Server

- Click the Server or Gateway you wish to edit

SensorView Server
Gateway 000003FC
Gateway 004488BA

Time Zone and DST as:
America/New York

4. Uncheck the **Edit Coordinates** box to edit the Country/State/City fields

For sunrise/sunset (astronomical time offsets):

Choose nearest location:

Country:

State:

City:

Latitude North (Degrees, Minutes)

Edit Coordinates

For sunrise/sunset (astronomical time offsets):

Choose nearest location:

Country:

State:

City:

Latitude North (Degrees, Minutes) Longitude East (Degrees, Minutes)

Edit Coordinates

5. Click **Save** to apply your changes

View Device Properties

1. Click the *Devices* tab



- Using the nLight Network tree to the left, find the device you wish to view

The screenshot displays the nLight SensorView web interface. On the left is a network tree under 'nLight Network'. The tree is expanded to show 'Training Room' and its sub-items: Back Bridge, Lobby, Lunch Area, Supply Closet, nBRG 8, nBRG 8 (000F7D60), Bathroom, Bathroom, Bathroom Corridor, nBRG 8 (00168B5A), Training Area, nBRG 8 (001C1819), nBRG 8 (001C184C), Port 2, nBRG 8 (001C1894), Port 8, Port 1, Training Annex Room, Annex, Bathroom, Classroom, Kitchen, Office, Storage, Upstairs Gateway, BRIDGE 1, IT Room, BRIDGE 2, and Hallway - Restroom.

The main content area shows the 'Properties' page for a device. At the top, there are navigation tabs: Admin, Green Screen, Log, Overview, and Log Out (administrator). Below these are tabs for Devices, Control Channels, Group Settings, Profiles, Schedules, and Users. The 'Properties' tab is active, with sub-tabs for Current Settings, Default Settings, and Status. The device name is 'Training Room (nGWY2) [G...]'.

The device information includes:

- Device name: nGWY2 Gateway 2: CPU Unit
- Buttons: Refresh network, Rediscover
- Basic info section:
 - ID: 004488BA
 - Firmware Version: F235C001_1.2.32818 / F235C002_2.6.30.1
 - Label: Training Room
 - Notes: (empty text area)
 - Save button
- Advanced details section: (collapsed)

3. Click the desired device; the properties will populate the Devices area to the right

The screenshot displays the nLight SensorView web interface. At the top, there are navigation tabs: Admin, Green Screen, Log, Overview, and Log Out (administrator). Below these are main navigation buttons: Devices, Control Channels, Group Settings, Profiles, Schedules, and Users. The 'Properties' tab is selected, showing the configuration for an nCM-PDT-9 device. On the left, a tree view shows the network structure with 'nCM-PDT-9' highlighted under the 'Lobby' area. The main content area features a large image of the sensor, a description: 'nCM PDT 9 Standard Range 360° Sensor - Ceiling Mount, Low Voltage, Dual Technology (PDT)', and two buttons: 'Restore factory settings' and 'Rediscover'. Below this is the 'Basic info' section with fields for Device ID (00000352), Firmware Version (F183E004Z-003 / F183E002E), Label (nCM-PDT-9), and Notes. A 'Save' button is located below the Notes field. At the bottom, there are sections for 'Advanced details' and 'Health'.

4. Change the Label, Notes, and other areas to your requirements

5. Click **Save** to apply your changes

▼ Basic info

Device ID: 00000352

Firmware Version: F183E004Z-003 / F183E002E

Label: nCM-PDT-9

Notes: Third from the window

Save

Viewing / Editing Normal Device Settings: Sensors/WallPods/Power Packs

1. Click the **Devices** tab

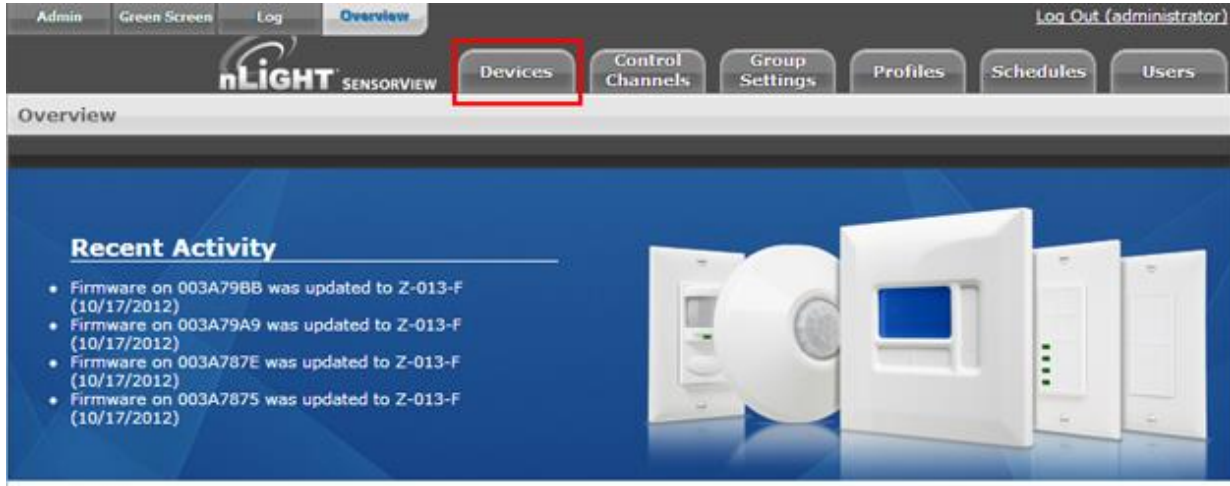

2. Using the Device tree to the left, find the device you wish to view

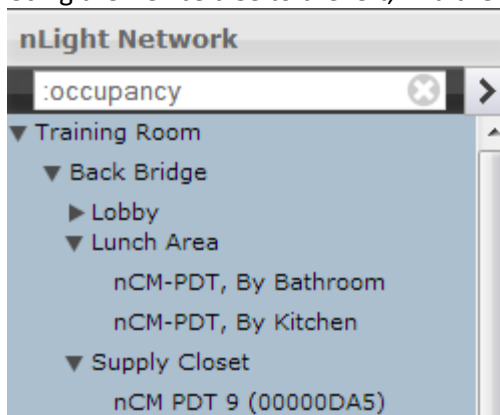

3. Click the desired device

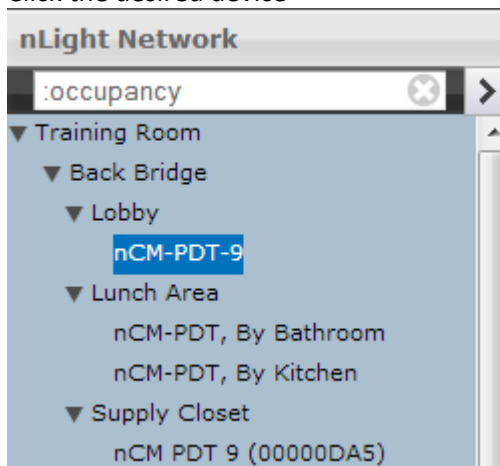

SensorView Manual

- Click the **Current Settings** tab (if it's grayed out, settings aren't applicable to the current selection, & you need to pick another device)

- Your device's specific settings (varies from device to device) will show
- Modify the settings in the dropdown/checkcheckbox fields to your specifications (You may also revert to device defaults by clicking the button at the top)

- After you've made your changes, click the **Apply Settings** button to save your modifications

Note: hovering over a setting will cause its definition to appear in the information pane at the bottom of the page. The [SensorView Terms Glossary](#) also lists these definitions.

Time Delay: The length of time an occupancy sensor will keep the lights on after it last detects occupancy

Viewing / Editing Scene Selector / nIO Settings:

1. Click the *Devices* tab



2. Using the nLight Network tree to the left, find a Scene Selector or nIO

3. Click the desired device

The screenshot displays the nLight SensorView web interface. On the left, a tree view shows the network structure under 'nLight Network'. The 'Training Area' is expanded, showing various nPODM and nIO devices. 'nIO, Row 4, Left' is selected and highlighted in blue. On the right, the 'Properties' tab is active, showing a 3D model of the 'sensorSwitch' device. Below the model, the device is identified as 'nIO Universal Input/Output/Dimming Device'. A 'Device control - Pole 1' slider is set to 100%. There are buttons for 'Restore factory settings' and 'Rediscover'. The 'Basic info' section shows: Device ID: 00005752, Firmware Version: F227B001Z-011 / F227B002F, Label: nIO, Row 4, Left, and a Notes field. There are also 'Save' and 'Advanced details' sections.

- Click the **Current Settings** tab (if it's grayed out, settings aren't applicable, & you need to pick another device)



- For Scene Selectors, the currently assigned action for each of the four control mode buttons is displayed. Change settings for each button via the dropdowns. Click **Apply Settings** to save.

SensorView Manual

Properties		Current Settings	Default Settings	S
Apply Settings		Revert to Defaults		nIO, Row 4, Left (nIO)
Override & Time Delay				
Override:				
Normal				
Broadcasting				
Switch Broadcasting:				
Enabled				
Tracking				
Tracking:		Special Switch Tracking Mode:		
Select Type(s)		Normal		
Photocell				
Follow Photocell Mode:				
Disabled				
Dimming				
Dimming Range (High):		Dimming Range (Low):		
100%		10%		
Dimming Rate:		Idle Time Until Dim:		
Normal		7.5 min		
Infinite Dimming Time Delay:		WallPod Dimming Adjustments:		
Disabled		Permanent		
Special Modes				
Special Modes:				
Normal				
Sweep				
Sweep Exit Time:		Sweep Grace Period:		
15 sec		5 sec		
LED:		Absolute Lower Dim Limit:		
Normal		0V		
Dual Zone Offset:		Button Mode:		
0%		Disabled		
100 Hour Burn In:		nIO Input:		
Disabled		Disabled		

Control Mode Options (triggered through a button push or nIO input event):
Scene Control – Initiates corresponding scene outlined in Default Settings
Wallpod – On/Off functionality for the associated lights
Sweep – Initiates sweep for the corresponding number in Default Settings
Disabled – Disables the corresponding button

To create Scene Selector / nIO Scenes & Profiles:

1. Click the **Devices** tab



2. Using the nLight Network tree to the left, find a Scene Selector or nIO

3. Click the desired device

The screenshot displays the nLight SensorView web interface. On the left, a tree view shows the network structure under 'nLight Network'. The 'Training Area' is expanded, showing various devices including 'nIO, Row 4, Left', which is highlighted in blue. On the right, the 'Properties' tab is active, showing a 3D model of the 'sensorSwitch' device. Below the model, the device is identified as an 'nIO Universal Input/Output/Dimming Device'. A 'Device control - Pole 1' slider is set to 100%. There are buttons for 'Restore factory settings' and 'Rediscover'. The 'Basic info' section shows the following details:

- Device ID: 00005752
- Firmware Version: F227B001Z-011 / F227B002F
- Label: nIO, Row 4, Left
- Notes: (empty text box)

Buttons for 'Save', 'Advanced details', and 'Health' are also visible at the bottom of the properties panel.

- Click the **Default Settings** tab (if grayed out, settings aren't applicable to the current choice, & you need to pick a new device)

The screenshot displays the SensorView interface with the 'Default Settings' tab selected. The interface includes a navigation bar with tabs for 'Properties', 'Current Settings', 'Default Settings', and 'Status'. Below the navigation bar, there is a header for the device: 'nIO, Row 4, Left (nIO) [Zone]'. A clock shows the date 'Thursday, October 18, 2012' and the time 'noon'. A large image of the 'sensorswitch' device is shown. Below the image, the device is identified as 'nIO Universal Input/Output/Dimming Device'. A control panel for 'Device control - Pole 1' shows a slider set to '100%'. There are buttons for 'Restore factory settings' and 'Rediscover'. A section titled 'Basic info' contains fields for 'Device ID: 00005752', 'Firmware Version: F227B001Z-011 / F227B002F', 'Label: nIO, Row 4, Left', and 'Notes'. A 'Save' button is located below the notes field. At the bottom, there are expandable sections for 'Advanced details' and 'Health'.

- Select a button, type a name to associate with it, then select which mode you wish to run in:
 - Wallpod* – Assigns on/off control to button
 - Scene* – Assigns created scene to button
 - Profile* – Assigns an existing profile to button
 - Sweep* – Assigns sweep to selected button

SensorView Manual

For buttons designated with Scene Mode:

Create a scene via the device settings & exceptions dropdowns.

The screenshot displays the 'Default Settings' tab for a device named 'nPODS WH (0000AB11)'. On the left, a list of scenes is shown: '1: 100%' (selected), '2: 75%', '3: 50%', and '4: pauls test'. The main configuration area includes:

- Name:** 100% **Mode:** Scene
- Photocell Tracking:** All Devices: Disabled
- Dimming Range (High):** All Devices: 100%, Except nIO Pendant: 50%
- Sweep:** Sweep Exit Time: 1 sec, Sweep Grace Period: 5 sec
- Expiration Time:** Scene 1: Infinite, Scene 2: Infinite, Scene 3: Infinite, Scene 4: 1 Hour
- Profile Override:** Disabled
- nClass:** Disabled

SensorView Manual

For buttons designated with Profile Mode:

Select an existing profile you wish to attach to the selected button.

The screenshot displays the 'Default Settings' tab for a device. At the top, there are buttons for 'Save Defaults' and 'Save Defaults and Apply Now', and a breadcrumb path: 'nPODS WH (0000AB11) (nPODS WH) [Zone]'. Below this, a table lists four profiles: '1: 100%', '2: 75%', '3: 50%', and '4: pauls test'. The '1: 100%' profile is selected. To the right, the 'Name' field is set to '100%', the 'Mode' is 'Profile', and the 'Profiles' dropdown is set to 'Scott Test'. Below the profile list, the 'Sweep' section contains 'Sweep Exit Time' (1 sec) and 'Sweep Grace Period' (5 sec). The 'Expiration Time' section has four dropdowns: 'Scene 1: Infinite', 'Scene 2: Infinite', 'Scene 3: Infinite', and 'Scene 4: 1 Hour'. At the bottom, 'Profile Override' and 'nClass' are both set to 'Disabled'.

For buttons designated with Sweep Control Mode:

The Sweep Exit and Sweep Grace Period dropdowns allow you to set a time delay, after which the value of the remaining time delay in all applicable devices will be changed to the input value. This is helpful if you wish to quickly turn all the lights in a zone or building off without affecting any of the device settings.

SensorView Manual

Properties Current Settings **Default Settings**

Save Defaults Save Defaults and Apply Now nPODS WH (0000AB11) (nPODS WH) [Zone]

1: 100% Name: 100% Mode: Sweep

2: 75%

3: 50%

4: pauls test

Sweep

Sweep Exit Time: 1 sec Sweep Grace Period: 5 sec

Expiration Time

Scene 1: Infinite Scene 2: Infinite

Scene 3: Infinite Scene 4: 1 Hour

Profile Override: Disabled nClass: Disabled

- Click **Save Defaults and Apply Now** to save, then click another number to change its settings.

Save Defaults Save Defaults and Apply Now

Viewing / Editing Zone Settings

1. Click the **Group Settings** tab
2. Using the nLight Network tree to the left, click the checkbox next to the desired Zone to select all devices within the zone.
Note: Each port of a Bridge is considered a zone
3. Create the list of settings to be modified by selecting settings one at a time from the provided dropdown field
4. To prevent a device from having a particular setting apply, create an exception
5. After you've made your changes, click the **Save Defaults** button to save your modifications
6. Refer to the Appendix for specific details regarding each setting's meaning

Managing Profiles

The Profiles page provides the ability to create, edit, and delete all Profiles configured within the system. All Profiles displayed will be grouped with other Profiles sharing the same state: Synchronized, Mismatched, SensorView Only, or Gateway Only.

While creating or editing a profile the Device tree will operate in [MultiSelect mode](#), there is no limit on how many devices can participate in a given Profile. As Devices are added to the Profile more settings may become available on the right, settings are only displayed if there is a Device selected that contains it, settings will be omitted if no Devices selected support it.

The Scheduler, visible at the bottom of the screen, controls the Schedule for the Profile. Profiles can be configured to start/stop at a particular time of day, or based on an offset from Sunrise or Sunset. Recurrences specify how often the Profile should recur in the future, available Recurrences are Daily, Weekly, Monthly, and Yearly.

The Scheduler also contains a tab for Priority, which allows specification of how Scheduling conflicts should be handled. If two, or more, Profiles' execution times overlap then the Priority determines which Profile will run on each Device. The [Schedules](#) section provides a view of exactly how Scheduling conflicts will be resolved by Priority.

Create a Profile

1. Click the **Profiles** tab
2. Click on **New**
3. Profile will show up under the **SensorView Only** header
4. Select all Devices that should be in the Profile using the [Device Tree](#), as Devices are added more Settings will become available in the Settings area

5. In the Scheduler/Priority section, create a schedule with any required recurrences, then click **Create**. For additional schedules select **New Schedule** in the dropdown and repeat the previous process.
6. Click the **Priority** tab to modify the priority of the profile using the arrows. Priority will only matter if another Profile is scheduled to execute at the same time, on the same Device.
7. Select desired settings to be added / modified by the profile from the Settings dropdowns; choose values & pick exceptions, if needed.
8. Once all Settings and Schedules have been configured fill in the name for the profile and click **Save**, the Profile will then move under the **Synchronized** header.

Edit a Profile

1. Click the **Profiles** tab
2. Select a Profile Name
3. Edit the schedule & priority, clicking **Update** to save your changes when finished
4. Remove any existing settings by clicking the – button, modify the current values, or use the Add a Setting dropdown to add new ones
5. Repeat for each setting you wish to modify, then click **Save**

On Demand Profiles

SensorView provides the ability to command a Profile to **Run** or **Stop** on demand. This is often utilized for standard events that don't recur according to a specific Schedule, but requires the same lighting configuration.

When a Profile is run on demand it will not stop according to any Schedule, it must be stopped manually; other Profiles that are scheduled to run at the same time, or afterwards, will still execute normally. When a Profile is stopped on demand, and it has a schedule, it will still follow the next Recurrence of the Schedule.

To command a Profile manually:

1. Click the **Profiles** tab
2. Select a Profile Name
3. Click either **Run** or **Stop** to command the Profile

Delete a Profile

1. Click the **Profiles** tab
2. Select a Profile Name

3. Click **Delete** to permanently remove that profile
4. A pop-up will confirm that you wish to do this. Click **Ok**.
5. Repeat for each profile you wish to delete
***Please note: deleted profiles are permanently removed. Be certain you wish to delete the profile before proceeding.*

View Reports

SensorView provides a variety of generated reports detailing all configurable aspects of the nLight network. To view a list of available reports refer to [SensorView Reports](#).

To Generate a Report:

1. Click the **Admin** link
2. Click the **Reports** tab
3. Select the report you wish to run. Click **Generate Report**
4. Once run, print a report using the **Print Report** button, supported browsers all provide the option to Print to a PDF

Upgrading Devices

1. Click the **Admin** link in the top right
2. Click the **Updates** tab (or click the “Updates” link from the Overview page)
3. Check the selected items you wish to update (unchecked items will not update)
4. Click **Submit** at the bottom of the page

Downloading Firmware Cache:

Available when internet connection is present & an updated version of SensorView is available, enabling update downloads that are made available to an offline network.

Note: This process may be lengthy depending on the size of the network.

SensorView

Installing SensorView is a multi-step process that should only be completed by a qualified computer administrator. Before proceeding, please make the following items available to ensure a successful SensorView Installation:

- Windows Installation Disk (Required for Windows XP & Windows Server 2003)
- Active Internet Connection
- SensorView Registration Key (provided in each Gateway box)
- Cross wired CAT-5(e) cable ([click here for pinouts](#))

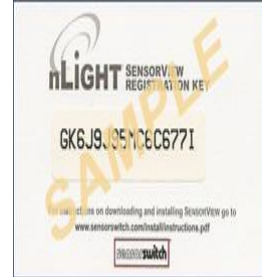

Step 1: Requirements

There are two types of installations available for SensorView:

Single-User / Commissioning

For use with any nLight network where a single user operates or commissions the system.

MINIMUM SPECS:	SUGGESTED SPECS:
Operating System: Windows 7	Operating System: Windows 7 or 8
Software: IIS 6.0, .NET 4.5.1	Software: IIS 8.0, .NET 4.5.1
Hardware: 1 GB RAM, 2 GB Hard Drive	Hardware: 2 GB RAM, 30 GB Hard Drive
Browser: Firefox, Chrome, Opera, or Internet Explorer 10+	Browser: Firefox, Chrome, Opera, or Internet Explorer 10+

Multi-User

For use with any nLight network where multiple concurrent web sessions are desired.

MINIMUM SPECS:	SUGGESTED SPECS:
Operating System: Windows Server 2003, Windows Server Web Edition, Windows Small Business Server 2003	Operating System: Windows Server 2008 or 2012
Software: IIS 6.0, .NET 4.5.1	Software: IIS 8.0, .NET 4.5.1
Hardware: 1 GB RAM, 2 GB Hard Drive	Hardware: 2 GB RAM, 30 GB Hard Drive
Browser: Firefox, Chrome, Opera, or Internet Explorer 10+	Browser: Firefox, Chrome, Opera, or Internet Explorer 10+

Step 2: Pre-Installation

SensorView requires pre-installation of both **IIS** and the **Microsoft .NET Framework**.

.NET Framework

The .NET Framework 3.0 is automatically installed with Windows Server 2008 & Windows Vista / 7 / 8. If you are NOT running either of these operating systems, click [here](#) and follow the .NET installation instructions.

IIS

IIS (Internet Information Services) is a Windows component that allows computers to host web applications. This component is required for hosting a SensorView installation, and will allow end users to view and control their SensorView install(s) remotely.

To install IIS, please click the link to your corresponding operating system below and follow the specific information for installing this component.

Please Note: Both Win XP & Server 2003 **require Windows installation disks** and are **NOT** downloadable from the web. Without Windows discs to install this component, SensorView installation cannot be completed:

- [Windows XP Pro \(32 bit\) – IIS 5.0](#)
- [Windows Small Business Server 2003 \(32 bit\) – IIS 6.0](#)
- [Windows Server 2003 \(32 bit\) – IIS 6.0](#)
- [Windows Server 2003 \(64 bit\) – IIS 6.0](#)
- [Windows Server 2008 – IIS 7.0](#)
- [Windows Vista / 7 / 8 – IIS 7.0_{\[DA3\]}](#)

Step 3: Installation

After completing the successful installation of IIS (and .NET), you are now ready to continue:

Download the **nLight SensorView installation package**:

1. Download the compressed .zip file (20 mb) from:
<http://www.sensorswitch.com/sensorview/setup.zip>
2. Unzip the file and run **setup.exe**.
3. Follow the instructional prompts to complete the installation of the SensorView application.

[SensorView Installation Best Practices](#)

It is recommended to do a full install of all offered features/plugins.

All boxes are checked by default. If they are not, please check them and click **Next**.

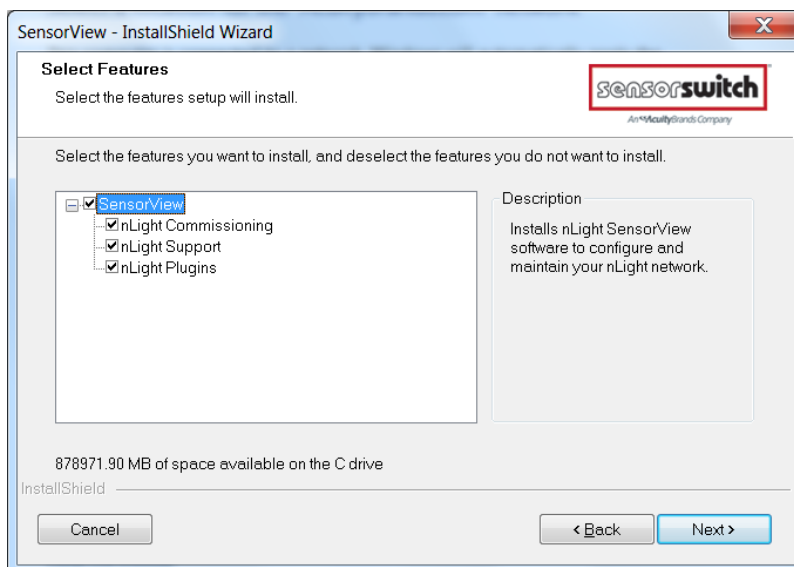

SensorView will require registration to complete the installation process.

SensorView Registration

This includes a license key as well as information about who is installing (the registration key is included on a small card with the gateway)

When the Install Shield wizard opens, select “**Default Web Site**” and click **Next**.

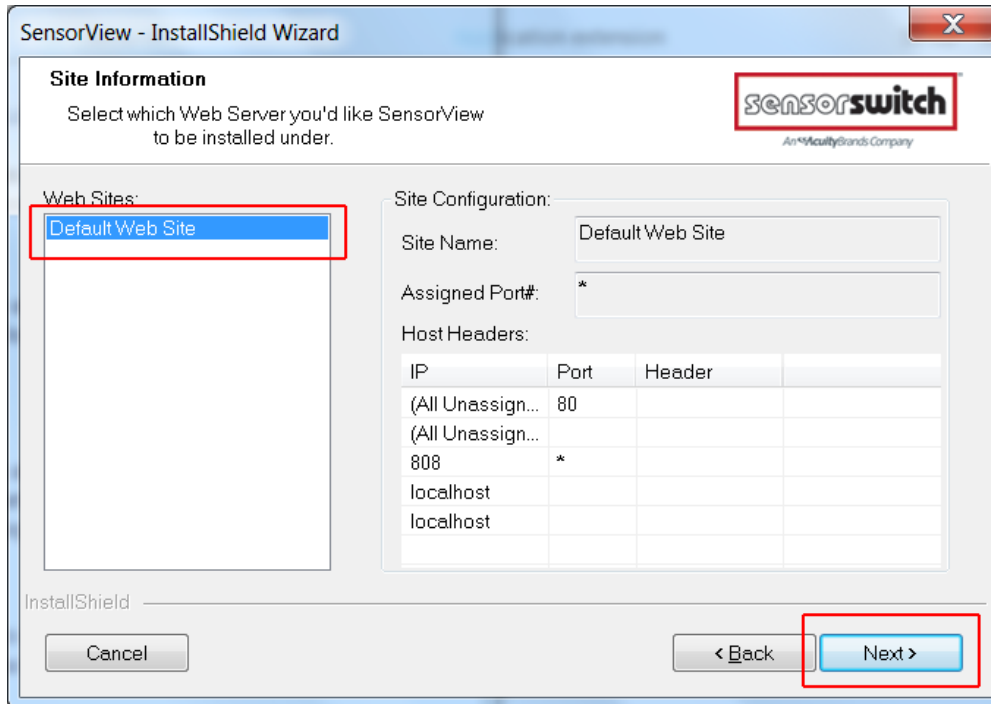

Click **Install**

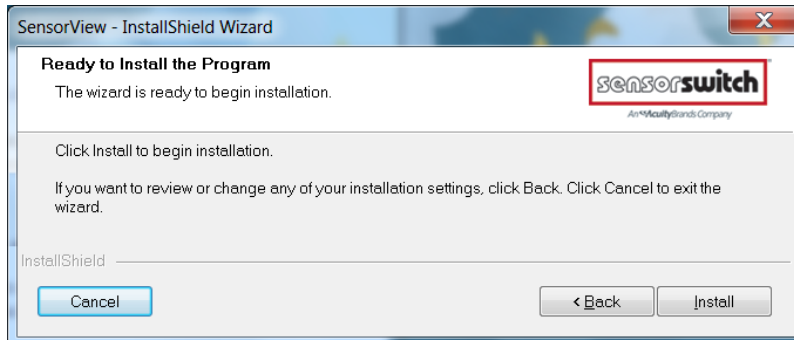

The install shield wizard takes a few moments to run.

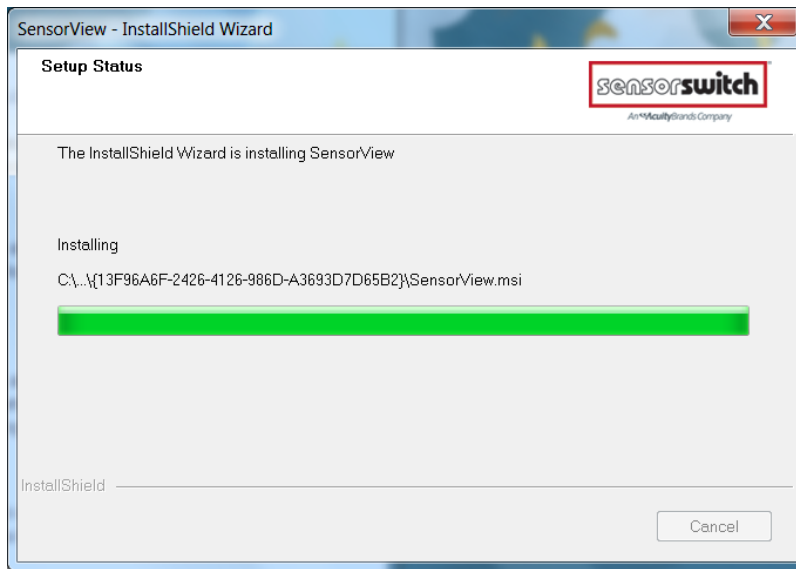

If you see the following message, click “install this driver software anyway”.

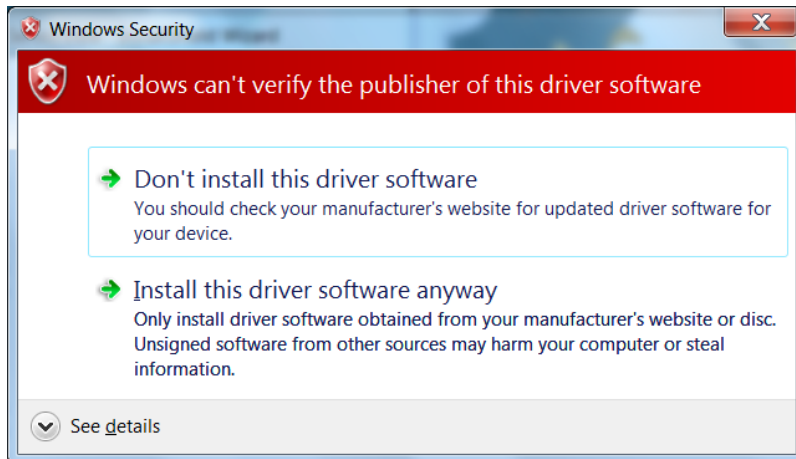

The installation is complete. Click the box to launch SensorView, or

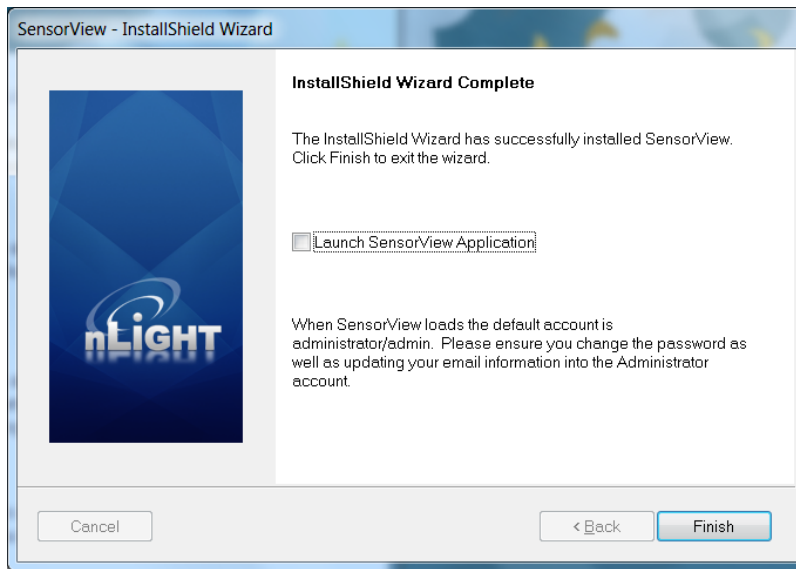

Click **Start, All Programs, Select nLight SensorView**

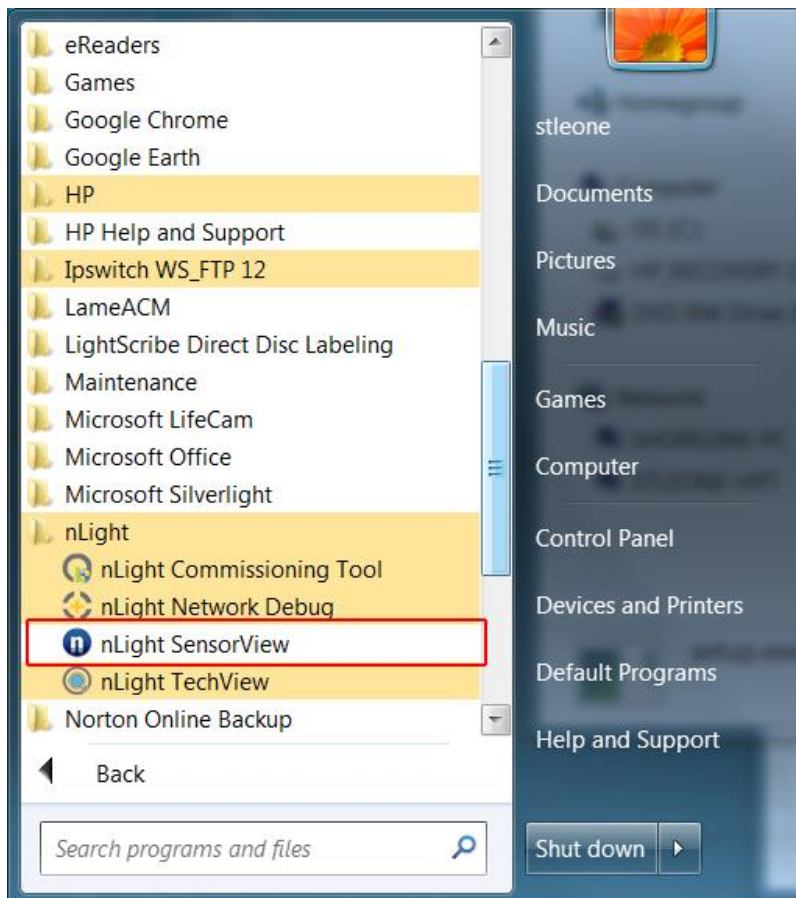

Launch SensorView on the desktop.

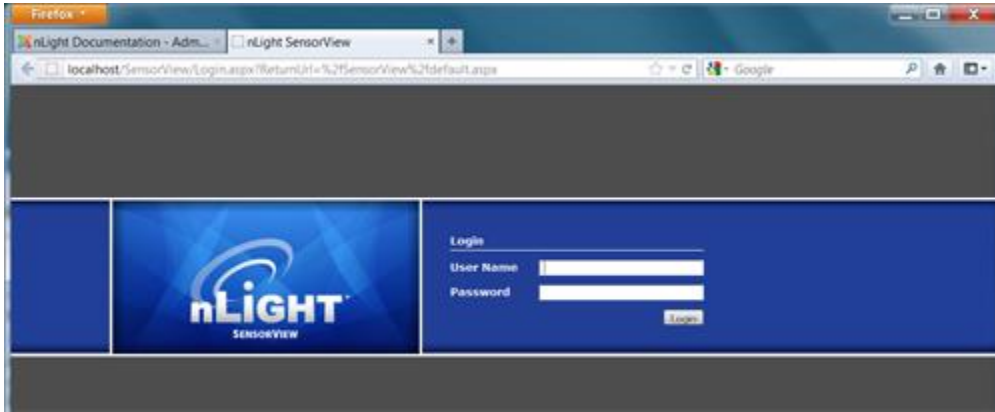

A username and password are required to login to SensorView. When SensorView is freshly installed, use the following:

Default User Name: **administrator**
Default Password: **admin**



Step 4: Connecting to Gateway

The Gateway uses the port labeled “Ethernet” to communicate with the computer running the SensorView software. There are several ways to connect to a gateway; please choose the method you wish to use:

Direct Connection

The following procedure will show you how to establish a direct connection between a laptop computer and a Gateway:

NOTE: a cross-wired CAT-5(e) cable is only required to connect this way to an nGWY1, nGWY2 does not require a cross-wired cable

1. If present, disable wireless networking card
2. Connect PC to Gateway’s Ethernet port with cross-wired (cross-over) CAT-5(e) cable
NOTE: a standard patch cable (straight through wired) will not work
3. Turn off/verify DHCP on Gateway
MENU > SETUP OPTIONS > SET [DHCP OFF]
NOTE: if pin is required, enter 1234
4. Enter static IP address for Gateway (for example 192.168.1.2)
MENU > SETUP OPTIONS > TCP/IP
5. Enter static IP address for Laptop (e.g., 192.168.1.5). The following instructions are for Windows XP. Other operating systems may require different procedures for changing network address.
 1. **START > CONTROL PANEL > NETWORK CONNECTIONS > LOCAL AREA CONNECTION > PROPERTIES**
 2. Highlight Internet Protocol (TCP/IP) in box and click Properties
 3. Click the radio button for “Use the following IP address”
 4. Fill in
IP address: 192.168.1.5
Subnet Mask: 255.255.255.0
Default Gateway: 192.168.1.1
 5. Click OK
6. Verify “Link Up” message on Gateway LCD screen. If “Link Up” message does not appear, reboot gateway
MENU > REBOOT
7. Launch SensorView
http://localhost/SensorView
8. Login to SensorView
Default User Name: administrator
Default Password: admin

9. Once SensorView detects the Gateway it will appear in device tree
10. If Gateway does not appear in the tree, call tech support; **1.800.535.2465**

LAN Connection

The following procedure will show you how to connect to a Gateway over an existing Ethernet Local Area Network (LAN).

NOTE: if the computer and Gateway are located on different subnets, use the instructions for connecting over a Wide Area Network (WAN).

1. Connect SensorView's computer to LAN using a standard patch cable
2. Connect Gateway's Ethernet port to LAN using a standard patch cable
3. If Link Up message appears on Gateway, go to step e, if not continue to next step
4. The Gateway can either use a dedicated IP address or acquire one from the network's DHCP server.
 1. To enter a dedicated IP address:
 1. Turn off DHCP on Gateway
MENU > SETUP OPTIONS > SET [DHCP OFF]
NOTE: if pin is required, enter 1234
 2. Enter static IP address for Gateway (for example 192.168.1.2)
MENU > SETUP OPTIONS > TCP/IP
 3. Return to main screen and verify "Link Up" message. If "Link Up" message does not appear, reboot gateway
MENU > REBOOT
 2. To use a DHCP assigned IP address:
 1. Turn On / Verify DHCP on Gateway
MENU > SETUP OPTIONS > SET [DHCP ON]
NOTE: if pin is required, enter 1234
 2. If DHCP fails, force the Gateway to acquire an address
MENU > GET IP ADDRESS
 3. Return to main screen. Verify "Link Up" message
5. Launch SensorView
From host computer: **http://localhost/SensorView**
From non-host computer on LAN: **http://[enter server name]/SensorView**
6. Login to SensorView
Default User Name: administrator
Default Password: admin
7. Once SensorView discovers the Gateway it will appear in device tree
8. If Gateway does not appear in tree, call Sensor Switch tech support; **1.800.535.2465**

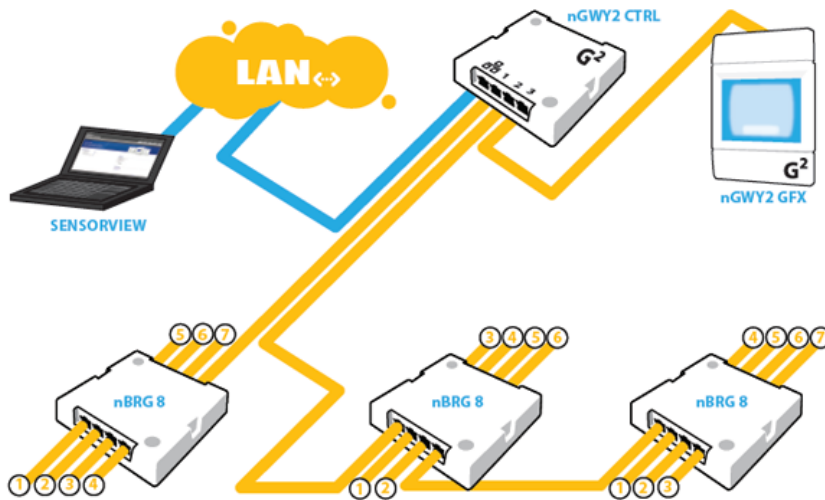

WAN Connection

If you would like to connect to a Gateway over an existing Wide Area Network (WAN), please call tech support at 1.800.535.2465.

[Crossover Cable Reference](#)

Virtual WallPods

With the Virtual WallPod applications, users can control their lighting from their desktop or iOS mobile device. Designed to look like WallPods®, these applications are an excellent alternative to remote controls, which are often lost and require battery replacement. Simple user permissions provide facility managers necessary administrative control.

Configuring SensorView

SensorView is a required component of the Virtual WallPods Plugin. It is used to setup and configure Users and the Virtual WallPods associated with them; as well as authenticate and process commands sent by Virtual WallPods.

Use of Virtual WallPods requires SensorView be online and accessible.

Update SensorView

Step 1

Before ^[DA4] starting, log into your SensorView page and click on Admin at the top right of the screen.

If you see a Plugins tab, skip Step 1 and proceed to [Start the nLight Virtual WallPod Server](#).

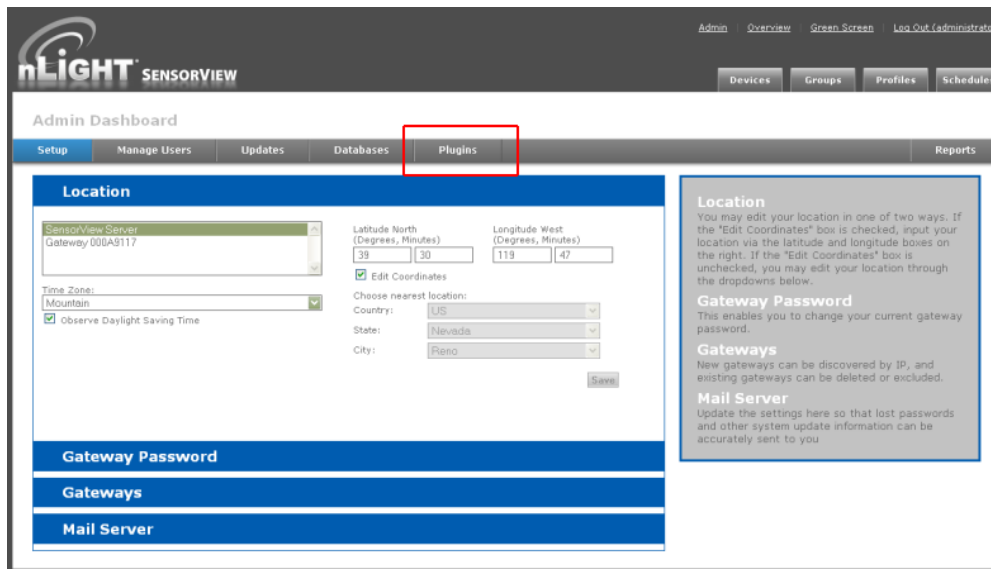

If you do not see a Plugins tab, click the **Updates** tab and update to the latest version of SensorView. Once the SensorView application update is finished, run the install file for SensorView and select **Modify**.

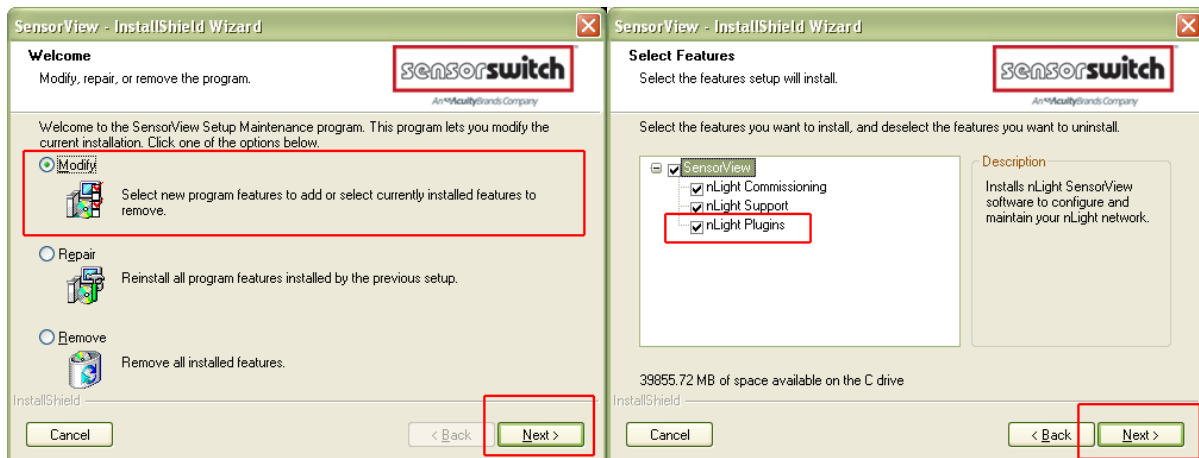

Click **Next**, and once the proceeding page opens check the **nLight Plugins** box, followed by **Next**.

Once the below screen appears the modification is complete, click **Finish** to close.

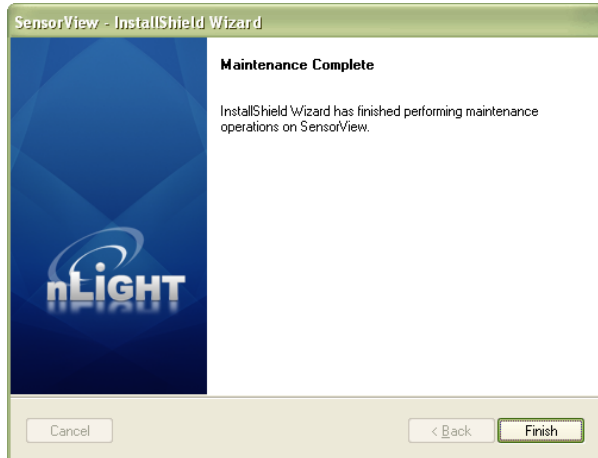

Virtual WallPod Server

Step 2

Once at the Admin Dashboard, click Plugins and Start the nLight Virtual WallPod Server.

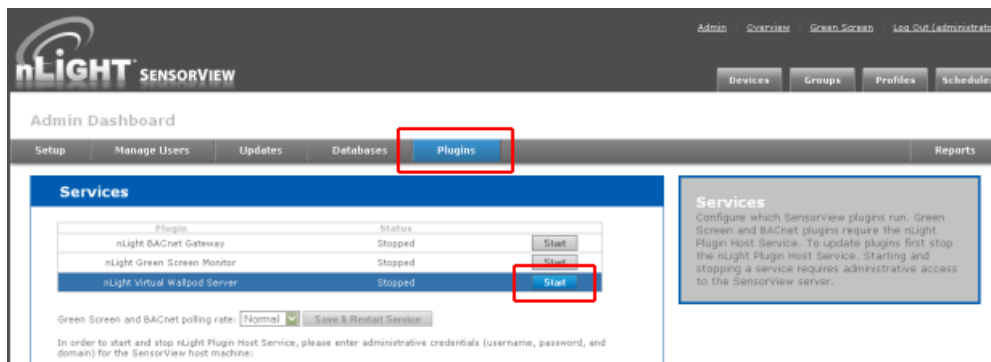

Notice that stopped will change to running.

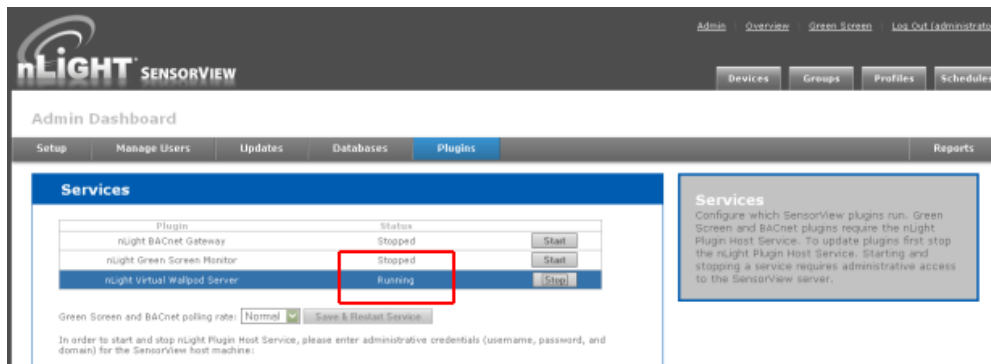

Virtual Controls

Step 3

Now that the nLight Virtual WallPod Server is running, go to the device page by clicking the **Devices** tab at the top right area of the screen. Once the devices page opens, click on the **Virtual Devices** tab, located in the same area.

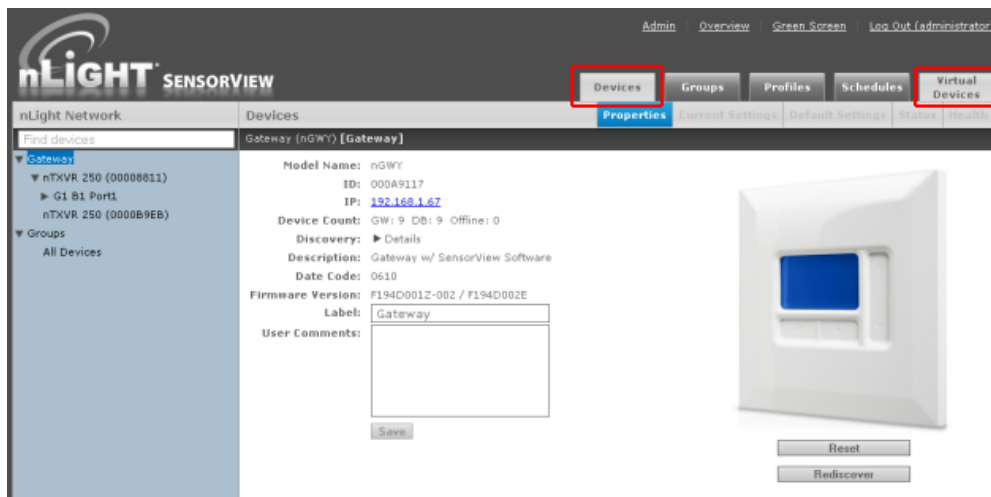

Select a user by clicking on the dropdown arrow



Virtual WallPod Switch

Step 4

Click the **Add a switch** button.

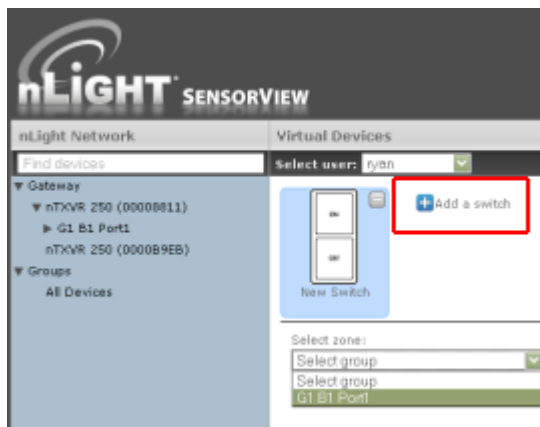

Control Zone

Step 5

Select a zone (bridge port) to control, as well as an individual device or switch broadcasting channel. For convenience, only the switch channels that devices are tracking within the zone will appear in the channel dropdown menu.

SensorView Manual

This screen shows the nLight Virtual WallPod controlling all devices connected to the zone that are tracking switch via Channel 1 **(A)**.

To control an individual device, select “Individual Device” from the **Control Type** dropdown **(B)**.

To label the nLight Virtual WallPod, highlight the **Switch Label** box and enter the preferred Switch Label **(C)**.

If the nLight Virtual WallPod is to control dimming or a 2-Pole device, check the appropriate box **(D)**.

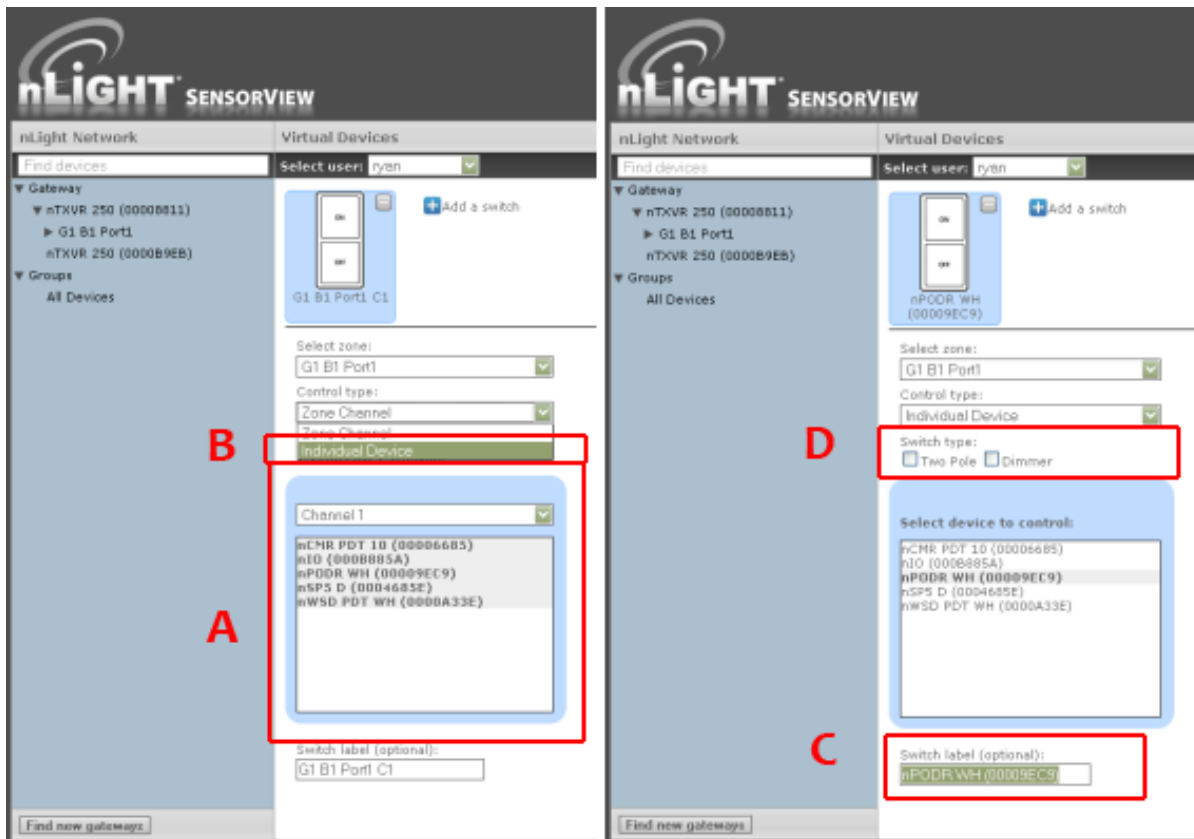

Virtual WallPod Application

Download the **Virtual WallPod** application from the Overview page of SensorView. Click the **Overview** tab at the top right portion of the screen, then Virtual WallPod under the Downloads section (bottom right) to download.

Note: The download link will only be shown if the Virtual WallPod Plugin has been enabled.

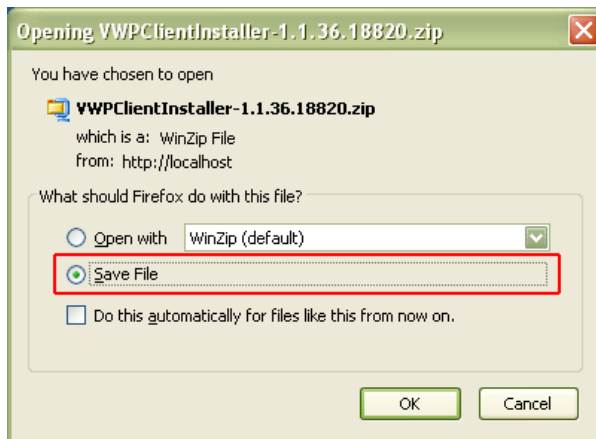
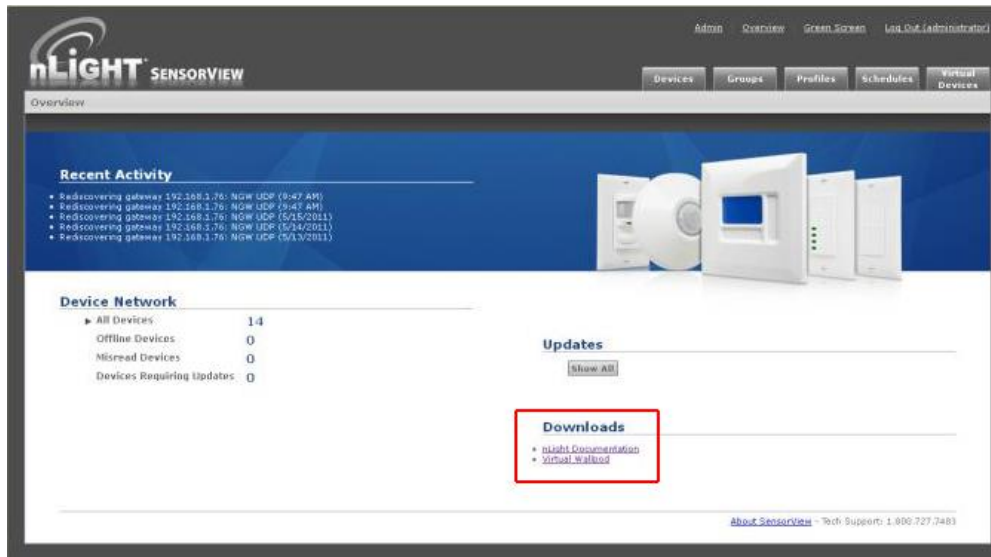

It is recommended to save this file to a flash drive so that it can be installed to other machines throughout the network.

Once the files have been downloaded and extracted to a folder, locate it and run setup.exe

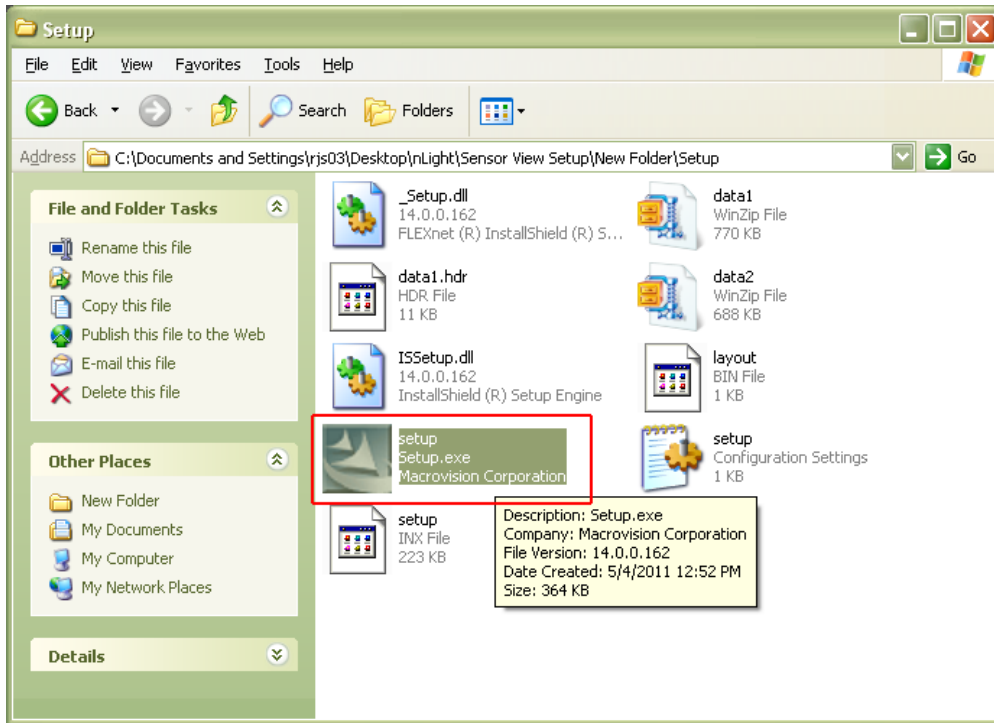

Next, follow the setup file's installation steps.

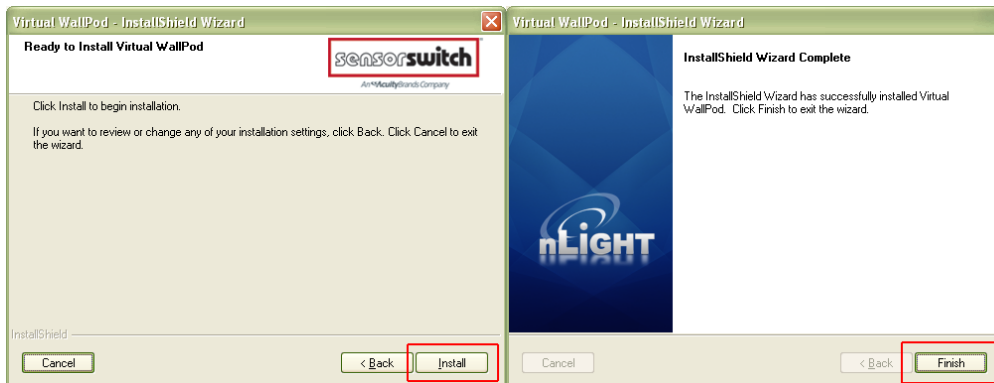
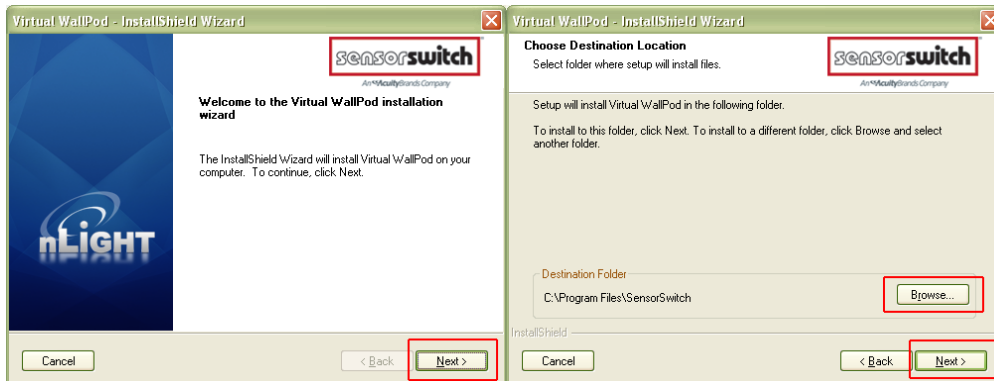

Once the install is complete, follow the path.

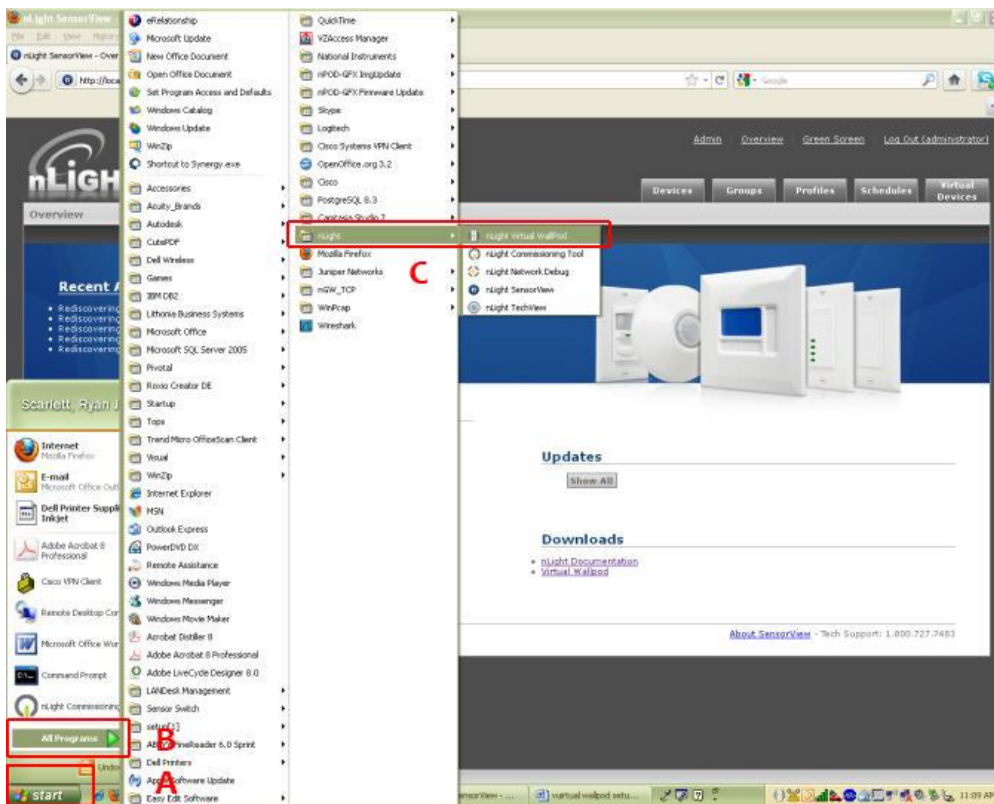

Start/All Programs/nLight/nLight Virtual WallPod. (above)

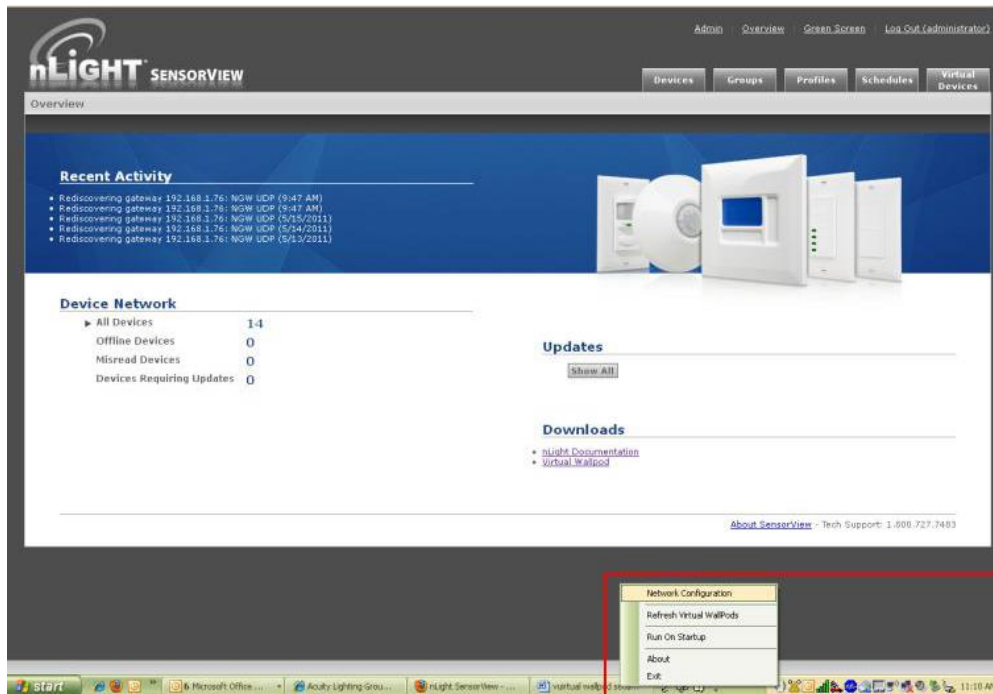

Once the icon for the nLight Virtual WallPod appears in the Taskbar, right-click it and enter the network configuration.

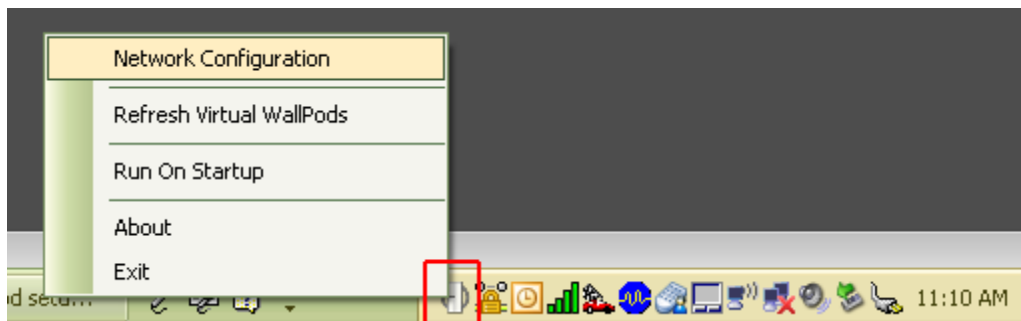

SensorView Manual

If the nLight Virtual WallPod app is installed to the SensorView host machine, the SensorView URL will match the **(left)** screenshot.

If it is installed to a remote machine (that is on the same LAN or subnet) the SensorView URL will be: `http://[host name or IP address]/sensorview`
 Log in as a user assigned one or more Virtual WallPods in SensorView.

The nLight Virtual WallPod is now running and will control the assigned relays.

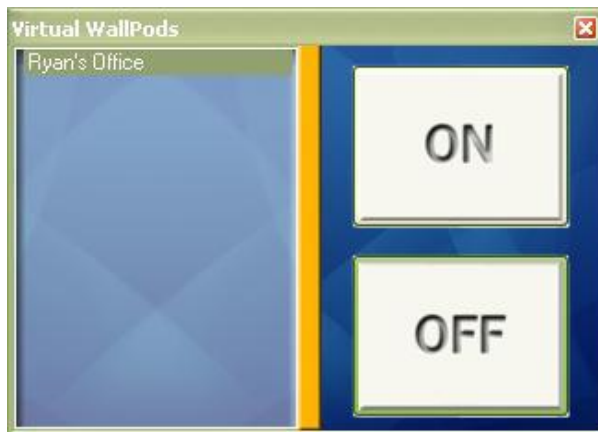

Now that setup for the host machine is complete, the iOS app can be downloaded and installed.

Virtual WallPod iOS App

This section details how to install and setup the Virtual WallPod software for iOS devices.



Download and Install iOS application



Go to the **App Store** on the device that will have the nLight Virtual WallPod installed.

Search for **nLight Virtual WallPod**.

Note that the App is **free of charge**, as is all nLight software.

Click **FREE**, followed by the green **INSTALL** button that appears.

(note: an **iTunes account** is required)



Once installed, **click the WallPod App** icon to launch.

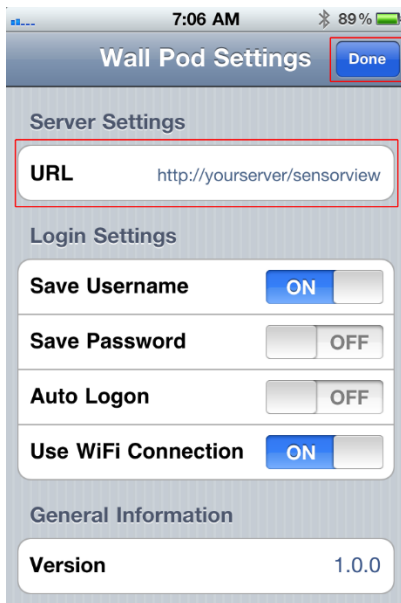
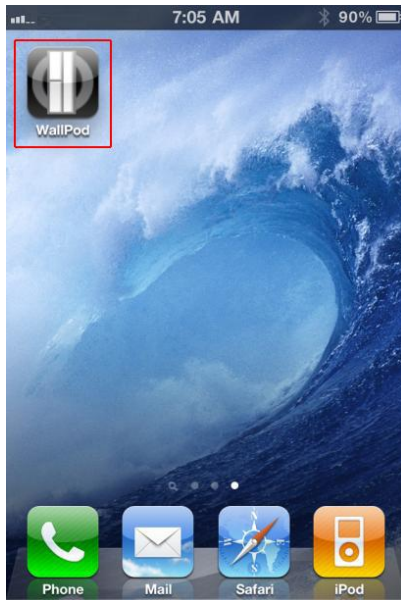

The app will open the WallPod Settings page the first time it's launched.

Enter the Server Settings URL (replace "yourserver" with host machine's IP address).

Set **Save Password**
and **Auto Logon** to desired settings.

Click **Done**.

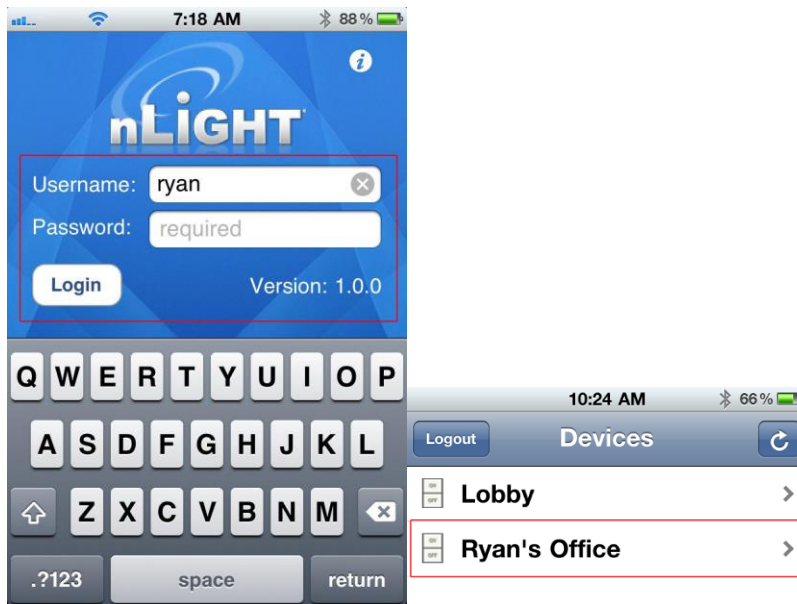

Login with the user credentials for the nLight Virtual WallPod you wish to control. (left)

Select a switch from the devices list. (right)

Installation is now complete.



Notice that the switch is backlit, indicating that the **relay** controlled by this nLight Virtual WallPod is **closed**, i.e., “turned on.”

Green Screen



This SensorView module logs and analyzes system and building performance. A “Savings Scorecard” calculates energy savings in kWh or dollars.

As with SensorView itself, installing the GreenScreen plug-in should be performed by authorized network administrators.

This will entail installing and setting up a database (PostgreSQL), a driver to connect to the database, a DSN for the data source, initializing the database, starting GreenScreen, and configuring GreenScreen options in SensorView.

Setting up PostgreSQL

Setting up PostgreSQL on a computer requires downloading and installing the application, configuring the database to accept remote connections, and restarting the database server.

- PostgreSQL is a separate product that is maintained and developed entirely separate from SensorView and is in no way affiliated with nLight, SensorSwitch, or Acuity Brands.
- For the remainder of this document the phrase “X.Y” will refer to major and minor versions of the version of PostgreSQL being installed; for example: 9.0, 8.4.
- GreenScreen is compatible with PostgreSQL versions 8.4 or higher (9.0 recommended).

1.1: Installing PostgreSQL

SensorView can use an existing PostgreSQL database or a dedicated one. Which option is most appropriate is at the discretion of the system owner. [Download](#) the most recent version for either Windows x86-64 (64 bit) or x86-32 (32-bit). A few notes on the installer:

Super-User Creation Screen:

The screen below configures the default super-user account for PostgreSQL, take note of these

credentials as those will be the default login account and password for the PostgreSQL database.

Port Configuration Screen:

The screen below allows for configuration of the port that PostgreSQL will use for connections. Use whatever value is required by system administrator. Note, SensorView and GreenScreen can be configured to use any port value.

Advanced Options:

The screen below allows for configuration of the locale that PostgreSQL is operating in. The default is almost always sufficient. If the installation site has specific requirements then select the most appropriate option from the drop down. The selected option does not seriously affect GreenScreen operations.

On the final screen, push “Next” to finish the installation of PostgreSQL onto the local computer.

1.2: Allowing Remote Connections

This step is only necessary if SensorView and the PostgreSQL database reside on separate computers. By default, PostgreSQL will not allow any remote connections; to change this, administrative access to the host machine for the database is required. To setup PostgreSQL to allow remote connections, go to the directory PostgreSQL was installed at (by default C:\Program Files\PostgreSQL), from that folder open the file at X.Y\data\pg_hba.conf; this file can be opened in notepad or any generic text editor. For how to configure pg_hba.conf, as well as any questions, refer to: [8.4 documentation, 9.0 documentation](#)

For all database versions, adding the following line to the bottom of the file to allow ALL remote connections to the database:

```
host all 0.0.0.0/0 md5
```

Note, allowing all connections is a potential security risk that should be weighed by system owners.

Save the changes and close the file. PostgreSQL will now accept remote connections from the configured host.

1.3: Tuning PostgreSQL (Optional)

By default PostgreSQL is tuned for systems with low memory sets. By changing a few configuration parameters GreenScreen database queries can be significantly sped up. To

change configuration options go to the directory in which PostgreSQL was installed (by default C:\Program Files\PostgreSQL). From that folder open the file X.Y\data\postgresql.conf with notepad or any generic text editor. Note that some of the following setting recommendations are based on the total system RAM available. Before entering the new values look up how much total RAM is installed in the computer (right click on My Computer and select Properties) and convert that value to MB (note that 1GB = 1024 MB).

The following changes are suggested to improve performance (note that leaving a # in front of a line denotes a comment and the value will be ignored; remove any leading # for the setting to take effect.

shared_buffers

Set to 25% of system RAM (not exceeding 512MB (256MB recommended for most installs)
default is 32MB

effective_cache_size

50-75% total RAM (in MB)
default is 128MB

After making changes to the configuration the PostgreSQL service must be restarted (1.4) before the new settings will take effect.

Note: Overall system performance may vary. Modifying values may have a result on overall system performance and stability, if problems persist revert modified settings to original values.

Sensor Switch is not responsible for any non-SensorView issues this may cause. [Additional tuning considerations.](#)

1.4: Restarting PostgreSQL

PostgreSQL must be restarted before the changes made to pg_hba.conf will take effect. If no changes were made to pg_hba.conf then this step is unnecessary. Go to Start Menu -> Control Panel -> Administrative Tools -> Services (Windows XP / Server 2003) or Start Menu -> Control Panel -> System and Security -> Administrative Tools -> Services (Windows Vista / 7 / Server 2008).

In the services window select the following service:

8.4

PostgreSQL Server 8.4

9.0

(32 bit) postgresql-9.0-PostgreSQL Server 9.0

9.0

(64 bit) Postgresql-x64-9.0

Right click on the relevant service name and select Restart; this will restart the database server.

1.5: Firewall Setup

If the computer running PostgreSQL is a different from the computer running SensorView, then the firewall on the computer running PostgreSQL may need to be updated to allow for incoming connections on whichever port PostgreSQL was configured to listen on. This will vary depending on the firewall software in use.

Setting Up Database Connection

A connection to the database that GreenScreen will store data in must be configured. This involves downloading and installing a driver for the database and configuring a system DSN that specifies the connection parameters to SensorView and GreenScreen. Both steps 2.1 and 2.2 must be performed on the computer that is running SensorView.

2.1: Installing a PostgreSQL Driver

For SensorView to connect and control the PostgreSQL database a driver must be installed on the machine hosting SensorView. [Download the Windows driver](#) (x32 and x64). After downloading open the zip file, run psqlodbc.msi, and install the driver.

2.2: DSN Configuration

DSNs provide a way to configure a datasource connection in a standard consistent way that can be used throughout the machine. A DSN must be configured to allow SensorView and GreenScreen to connect to the database; this must be done on the machine running SensorView. A DSN consists of a name, database, server, port, user, password, and SSL connection requirements. Locating the correct DSN configuration tool varies depending on the specific version of Windows and whether or not it is 64 bit.

- To configure a DSN for Windows XP 32 bit / Server 2003 bit go to:
Start Menu -> Control Panel -> Administrative Tools -> Data Sources (ODBC)
- To configure a DSN for all 64 bit variants of Windows go to:
Start Menu -> Run -> type C:\Windows\SysWOW64\odbcad32.exe and press Enter (Assuming Windows is installed to C:, otherwise substitute correct system path)
- To configure a DSN for Windows Vista 32 bit / 7 32 bit / Server 2008 32 bit go to:
Start Menu -> Control Panel -> System and Security -> Administrative Tools -> Data Sources (ODBC)

Once the Data Sources (ODBC) popup is open, select the tab System DSN, then press Add. Select a datasource from the list. The name of the driver will vary depending on what was installed, commonly for 32 bit the name will be "PostgreSQL Unicode", this is the driver that was previously installed during PostgreSQL setup (2.1). Select Finish and a form will appear with additional fields to fill out.

Fill out the form with the following values:

- **Data Source:** A custom name for the DSN that will be put into SensorView
- **Database:** nlight_system_data

- **Server:** IP Address or hostname of machine running PostgreSQL server. (127.0.0.1 or localhost for local computer)
- **Port:** Port PostgreSQL was configured to run on (by default 5432)
User name Account name for the database user
- **Password:** Account password for the database user
- **SSL Mode:** As appropriate for the database (disabled by default)

Select Save. Note, the Data Source name value as this is the field that must be entered into SensorView later. Note that pressing the Test button will fail with “database not found” until step 3.1 has been completed. For testing purposes you can change the datasource name to read ‘postgres’, and then test, if the connection is successful then change the datasource parameter back to nlight_system_data, otherwise check the other parameters that were entered.

Setting Up GreenScreen

In order to configure and run SensorView the plug-ins component must be installed. For new installs this can be accomplished by making sure that plug-ins is checked during the feature select portion of the SensorView install. For existing installations, run the installer and select Modify, then check plug-ins and push modify. Once the plug-in components have been installed, open SensorView and go to the Admin page and select Plug-ins.

3.1: Administrator Email (Recommended)

GreenScreen will notify the administrator via email if it encounters any issues while attempting to start. To configure email notification the administrator use of SensorView must have an email address entered; additionally the Mail Server section (found at Admin >Setup->Mail Server) must be filled out to allow for email to be sent from SensorView. Notification emails will be sent in two specific instances, if the host Windows service crashes (and the subsequent automatic restart fails); or if, while starting up, GreenScreen is unable to start due to version requirements, improper configuration, or any unexpected error.

3.2: Database Initialization

Once PostgreSQL, the database driver, and the system DSN have been set up and configured, the last step is to build the GreenScreen database and start the service. To build the database, in SensorView, go to Admin -> Databases. At the bottom of the screen is the GreenScreen Database Setup section. Input the name of the custom DSN that was previously configured and SensorView will build the database (upon hitting save). If the credentials supplied in the DSN do not have the create database privilege, then SensorView will prompt for credentials that do. SensorView will use those credentials to create the database and give ownership to the credentials in the DSN. Afterwards the other, higher, set of credentials will be discarded.

3.3: Starting GreenScreen

In order to start GreenScreen, the plug-ins component must have previously been installed (3.0); if this has not been done then there will be no Plug-ins tab. Proceed to the Admin screen in SensorView and select Plug-ins. The host service should already be running; if it is not then the username, password, and domain (optional) must be filled out, then start the nLight Plug-in Host Service. Once this is running GreenScreen can be started and stopped in the top window.

3.4: GreenScreen Operations

Within the accordion select GreenScreen; on this page options can be set that will configure how GreenScreen will compute savings and what units to display them in. Note that displaying savings in dollars requires electrical generation rate information be entered on the Admin->Plugins->GreenScreen section.

Display Options:

SensorView can be configured to show savings in dollars or kWh. For CO2 savings, the generation type for the electricity can be selected that will be used to determine CO2 savings.

Electrical Rates:

SensorView can be configured with the building's electrical rates. Set the rate and time periods in which the rate applies. These settings will only be used if SensorView is set to display savings in dollars.

Baseline Periods:

During these periods, SensorView will assume the building is occupied. Energy savings (whether in dollars or kWh) are relative to how much energy would have been spent, with all control points in the system being on for the duration of the baseline periods. Refer to the GreenScreen data sheet for a more detailed explanation of savings analysis.

Hit **Save Settings** to save the configuration.

Once SensorView has a valid Data Source which can connect to the database, it will display the current size of the database and the state of hosting service in the bottom left corner of the screen (completed in step 3.1).

SensorView Page Mapping

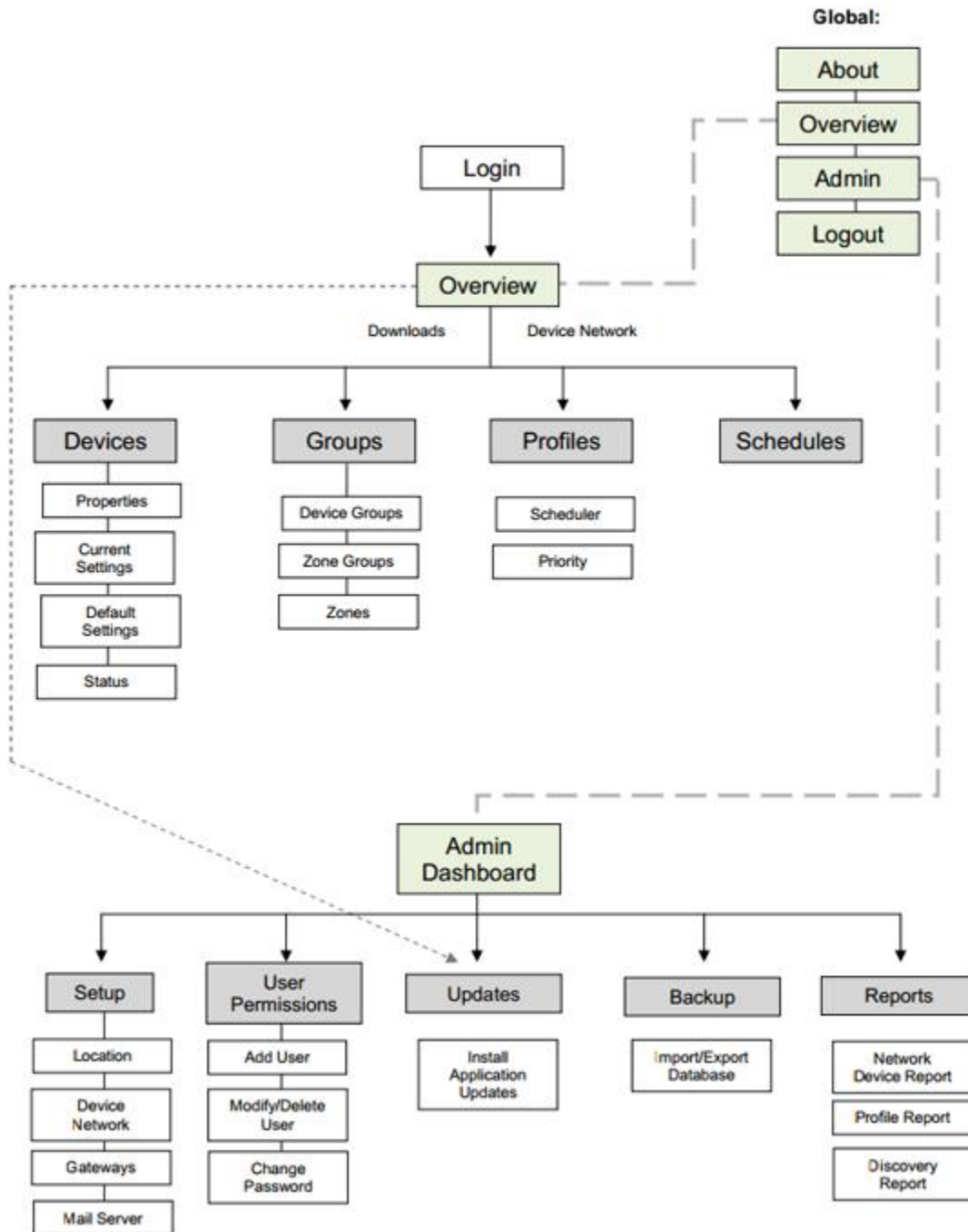

Overview

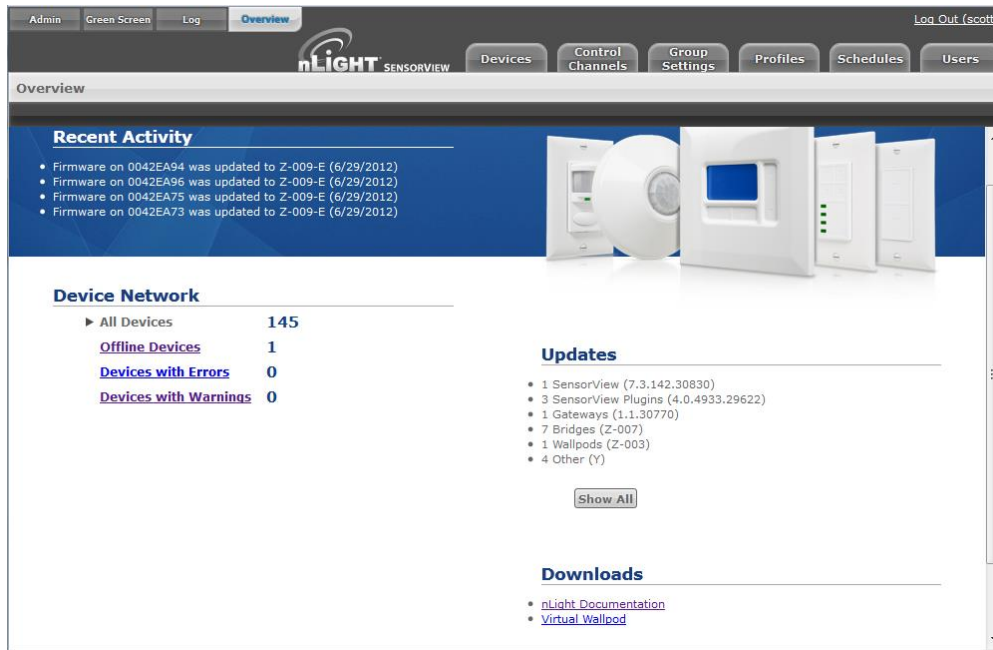

A successful login opens the **Overview** page, showing:

- a list of all recent activity, including Firmware updates (upper left)
- a **Device Network** report showing a count of offline and total devices (lower left)
- a list of all current updates available, with direct links to download and install them. (lower right)
- Upper left
 - **Admin** allows authorized administrators to setup and configure SensorView and perform updates.
 - **Green Screen** (upper left) provides a historical and real-time status on energy savings resulting from your installed nLight systems. For in-depth info: [Green Screen](#).
 - **Log** displays troubleshooting data.
 - **Overview** returns users to the Overview Screen.

The Overview page features four clickable tabs along the top.



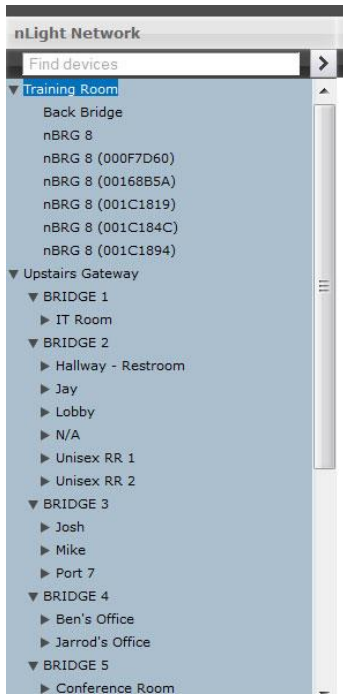

Green Screen

This SensorView **GreenScreen** module logs and analyzes system and building performance. A “Savings Scorecard” calculates energy savings in kWh or dollars.

Detailed graphs show performance over user selected time scales. This data can be used to monitor space and lighting usage, optimize time delays, and better utilize available daylight. Data is also provided to the user in downloadable reports.

Green Screen Admin

Green Screen
Requires configured database, see [installation instructions](#) (PDF) and Databases tab. Savings in kWh, dollars, or CO2. Generation type affects CO2 savings. Electric rates can be specified for time-of-day billing periods (e.g. peak/off-peak). Configure baseline times for when building is normally occupied. Calculated savings are relative to the cost of all control points being on for duration of baseline. See also [Green Screen datasheet](#) (PDF).

Period	Rate	(If rate is set to 0 or left blank, savings will be shown in kWh)	Time Range
Off-Peak	0.15		21:00-7:00
Shoulder 1	0.17		7:00-9:00
Peak	0.2		9:00-17:00
Shoulder 2	0.17		17:00-21:00

Day	Baseline - on time	Time Range
Monday		6:00-22:00
Tuesday		6:00-22:00
Wednesday		6:00-22:00
Thursday		6:00-22:00
Friday		6:00-22:00
Saturday		8:00-18:00
Sunday		8:00-18:00

Service status: **Running**, Database size: **221.92 MB**, Age data after **14** days Save Settings

Green Screen requires a configured database (see [installation instructions](#) and [Databases](#) tab).

The top pull-down allows users to select Savings in **kWh**, **dollars**, or **CO2**.

Generation type indicates a rate of CO2 production to energy consumption and affects CO2 savings.

Electric rates can be specified for time-of-day billing periods (e.g. peak/off-peak). Use the sliders to define time intervals for a specific facility using nLight devices.

Baseline times should be configured for each day of the week, according to normal building occupancy. Calculated savings are relative to the cost of all control points being on for the duration of the baseline.

The bottom line displays basic statistics and status about GreenScreen. It provides indications about the current data aging setting, the size of the database on disk, and the current status of the GreenScreen Plugin.

When configuration or changes are completed, click **Save Settings**.

See also [Green Screen datasheet](#) (PDF).

Admin

Admin Dashboard

Setup | Updates | Databases | Plugins | Reports

Location

Gateway Password

Gateways

Gateway IP:

Include	IP Address	Label	Status
<input checked="" type="checkbox"/>	10.65.67.52	Upstairs Gateway	Online <input type="button" value="Delete"/>
<input checked="" type="checkbox"/>	10.65.67.102	Training Room	Online <input type="button" value="Delete"/>

Mail Server

Location
You may edit your location in one of two ways. If the "Edit Coordinates" box is checked, input your location via the latitude and longitude boxes on the right. If the "Edit Coordinates" box is unchecked, you may edit your location through the dropdowns below.

Gateway Password
This enables you to change your current gateway password.

Gateways
New gateways can be discovered by IP, and existing gateways can be deleted or excluded.

Mail Server
Update the settings here so that lost passwords and other system update information can be accurately sent to you

The Admin tabs are for administrators only, and will not be accessed by a day to day end user.

Setup

The screenshot displays the nLIGHT SensorView Admin Dashboard. At the top, there are navigation tabs: Admin, Green Screen, Log, Overview, and Log Out (scottl). Below these are buttons for Devices, Control Channels, Group Settings, Profiles, Schedules, and Users. The main content area is titled 'Admin Dashboard' and has sub-tabs for Setup, Updates, Databases, Plugins, and Reports. The 'Setup' tab is active, showing the 'Location' configuration screen. This screen includes a text input for 'SensorView Server' (containing 'Gateway 000003FC'), a dropdown for 'Time Zone and DST as' (set to 'America/New York'), and dropdowns for 'Country' (US), 'State' (Connecticut), and 'City' (New Haven). There are also input fields for 'Latitude North (Degrees, Minutes)' (41 19) and 'Longitude East (Degrees, Minutes)' (-73 55), with an 'Edit Coordinates' checkbox. To the right of the main form is a help box titled 'Location' with instructions on how to edit location data. Below the main form are three blue buttons: 'Gateway Password', 'Gateways', and 'Mail Server'.

The Admin Setup screen displays four setup categories: **Location, Gateway Password, Gateways, and Mail Server.**

Location

- **Time zone** – Select Time zone from pull-down menu
- **Select Location** – Country, State, nearest City

Location settings allow a gateway to be aware of what time zone and daylight savings rules it should apply. Specifying the location also allows the gateway to determine the proper astronomical time for schedules using sunrise or sunset.

You may edit your location in one of two ways. If the “Edit Coordinates” box is checked, input your location via the latitude and longitude boxes on the right.

If the “Edit Coordinates” box is unchecked, you may edit your location through the dropdowns below.

Gateway Password

This enables authorized users to change current gateway password. Configuring a gateway password ties gateways to your particular SensorView, and prevents unauthorized users from using a different SensorView to modify the system; as well as restricting direct configuration access to the gateways.

Gateways

New gateways can be discovered by IP, and existing gateways can be deleted or excluded.

Mail Server

Update the settings here in order to receive important system notifications.

Updates

On this screen both software and device firmware updates are performed.

Software Updates

Current version: **7.1.134.30669**
New version: **7.3.143.30844**

To update software:
1. **On the server** (nlight.sensorswitch.com) run the [installer](#)
2. Select **Modify** and click **Next**

Firmware Cache Updates

Current version: **2011.09.07**
New version: **2012.06.26** [Update Firmware Cache](#)

WallPod Updates

<input type="checkbox"/>	Model	Label	ID	Gateway ID	V#	New FW#	Status
<input type="checkbox"/>	nPOD GFX		00092DA3	000003FC	X-Z-215	Z-?	None
<input type="checkbox"/>	nPODS WH		0000AB11	000003FC	Z-002-E	Z-003-E	None
<input type="checkbox"/>	nPOD GFX		00092DA4	000003FC	X-H	Z-I	None
<input type="checkbox"/>	nPOD GFX		0038E620	000003FC	X-H	Z-I	None

[Update Selected](#)

All updates are retrieved automatically from the internet and can be applied at the users' discretion. Additionally a firmware cache component is available that allows users to perform device updates without an active internet connection. Updates are only shown for components in which an update is actually available.

It is recommended that users run the latest version of SensorView and device firmware to ensure maximum efficiency and utility of nLight devices and networks.

For step by step information on how to update SensorView please see [SensorView Updates](#).

Databases

The Admin **Database** page allows you to create and load full system backups.

Admin Dashboard

SensorView Database

Backup_2011-06-22_10-20-54_AM
 Backup_2012-02-15_05-39-37_PM
 Backup_2012-03-21_04-18-38_PM
 Import_2011-02-01_09-33-57_AM
 Import_2011-02-01_11-43-07_AM
 Import_2011-02-03_08-45-59_AM
 Update_Backup_2011-10-31_01-43-23_PM
 Update_Backup_2011-10-31_11-02-14_AM
 Update_Backup_2011-11-12_01-57-52_AM
 Update_Backup_2011-11-30_11-29-42_AM

Backup name (optional):

Backup Erase Restore

Import Database
 Browse... Import
 Save to backups

Export Database
 Export

Clear Database

Green Screen Database

DSN: ssi-office-sv

Save

Database
 This page allows you to create and load full system backups.

Make Backup
 When a successful backup is made, an entry, complete with date and time stamp, will be created to verify the process is complete.

Restore/Erase
 To restore or erase a backup, click the desired entry followed by the appropriate Restore/Erase button below it.

Import/Export
 Choose a local database backup with the Browse button, then click Import to upload it and overwrite the current database with it. Click Export to download the current database.

Green Screen Database Requirements

1. Postgres database, version 9.0 or higher
2. ODBC drivers for Postgres
3. DSN created

[Installation instructions](#) (PDF)

Database Selection (left side of browser) displays all databases available for your admin user account. There are multiple types of databases from which to select.

- **Automatic_Backup** – Backup of a current or formerly active database. Databases are automatically backed up daily (by default) and receive this label prefix.

- **Backup** – a backup of a database that has been created on an as-needed or as-desired basis. Administrators may backup the database at any time. To backup a database from the list, select the desired database, enter a name in the “backup name” field, and click **Backup**.
- **Import** -an imported database
- **Update** – a database backup created while updating SensorView.

Backup, Erase, Restore Buttons

Any database selected from the list can be Backed up, Erased or Restored.

- **Make Backup** – When a successful backup is made, an entry, complete with date and time stamp, will be created to verify the process is complete.
- **Restore/Erase** – To **restore** or **erase** a backup, click the desired entry followed by the appropriate button.
- **Import** – Choose a database backup with the **Browse** button, then click **Import** to upload it and overwrite the current database.
- **Export** – Click to download the current database.

Plugins

The Admin dashboard for Plugins- **Services**, **BACnet** and **Green Screen**.

Services

The screenshot shows the nLight SensorView Admin Dashboard. At the top, there are navigation tabs: Admin, Green Screen, Log, Overview, and Log Out (scott). Below these are buttons for Devices, Control Channels, Group Settings, Profiles, Schedules, and Users. The main content area is titled 'Admin Dashboard' and has sub-tabs for Setup, Updates, Databases, Plugins (selected), and Reports. The 'Services' section is active, displaying a table of plugins:

Plugin	Status	
nLight BACnet Gateway	Stopped	Start
nLight Green Screen Monitor	Stopped	Start
nLight Virtual Wallpod Server	Running	Stop

Below the table, there is a 'Green Screen and BACnet polling rate:' dropdown menu set to 'Normal' and a 'Save & Restart Service' button. A note states: 'In order to start and stop nLight Plugin Host Service, please enter administrative credentials (username, password, and domain) for the SensorView host machine:'. Below this are input fields for Username, Password, and Domain. At the bottom of the Services section, there is another table for the nLight Plugin Host Service:

Service	Status	
nLight Plugin Host Service	Running	Stop

On the right side of the Services section, there is a summary box titled 'Services' with the following text: 'Configure which SensorView plugins run. Green Screen and BACnet plugins require the nLight Plugin Host Service. To update plugins first stop the nLight Plugin Host Service. Starting and stopping a service requires administrative access to the SensorView server.'

At the bottom of the Services section, there are blue bars for 'BACnet' and 'Green Screen'.

At upper left of the Services section each **Plugin** is listed along with its current **status**, either **Running** or **Stopped**.

Green Screen and BACnet Polling rate

Controls the rate at which these plugins are being polled. Increasing the rate may allow for Change of

Value notifications (BACnet) and GreenScreen reporting points to increase, but will result in additional network traffic. To change the polling rate for these plugins, select a new rate, and click **Save & Restart Service**.

The nLight Plugin Host Services status (either **running** or **stopped**) is indicated in the table below.

Controlling the nLight Plugin Host Service requires system administrator credentials (not SensorView credentials). You may have to contact your local IT department to retrieve the proper set of credentials.

Administrators can enter their credentials (**Username**, **Password**, and **Domain**) for the SensorView host machine, and click **Stop** or **Start**.

BACnet Admin Screen

The screenshot shows the Admin Dashboard for nLight SensorView. The 'Plugins' tab is selected, and the 'BACnet' settings are displayed. The settings include:

- Local Server Port: 47808
- Network Number: 429
- Max APDU Length: 1476
- APDU Timeout(s): 60
- Device Instance Base: 0
- Group Instance Base: 2097152
- Max string length: 1024

A 'Save Settings' button is located below the input fields. A note states: 'Device Instance Base value has to be smaller than Group Instance Base value.' Below this, the 'SensorSwitch BACnet Vendor ID: 429' is displayed. To the right of the settings is a 'BACnet' information box with a list of bullet points explaining the settings.

BACnet
Changes require restarting the plugin before they take effect.

- Local Server Port - port (UDP) SensorView listens on for BACnet commands
- Network Number - number nLight devices reside under in BACnet
- Max APDU Length - maximum packet size BACnet server accepts
- APDU Timeout - timeout used for BACnet messages
- Device Instance Base - base address (floor) nLight devices use for BACnet instance numbers
- Group Instance Base - base address (floor) nLight groups use for BACnet instance numbers
- Max String Length - maximum length of BACnet commands sent by SensorView. Allows adjustment of labels if BACnet server can't accept full strings; drops remainder.

BACnet administrative settings displayed are:

- **Local server port** – The port (UDP) on which SensorView receives BACnet commands
- **Network Number** – Number nLight devices reside under in BACnet. Default value is the nLight BACnet Vendor ID, 429.
- **Max APDU Length** – maximum packet size BACnet server accepts
- **ADPU timeout(s)** – timeout used for BACnet messages
Defined by the ISO 7816 standards, the APDU (Application Protocol Data Unit) is the communication unit between a reader and a card.
- **Device Instance Base** – base address (floor) nLight **devices** use for BACnet instance numbers
- **Group Instance Base** – base address (floor) nLight **groups** use for BACnet instance numbers

- **Max String Length** – (default is 1024) maximum length of BACnet commands sent by SensorView. Allows adjustment of labels if BACnet server can't accept full strings; drops remainder.

To change these settings enter the desired value in the appropriate field(s) and click **Save Settings**. Device Instance Base must be smaller than Group Instance Base value.

The nLight Plugin Host Service must be restarted before the modified settings will take effect.

Reports

Linked directly to the current active SensorView database, authorized administrators can view detailed reports on the following:

Network Device Report: Creates a printable report containing basic information about the devices in the network and their basic properties, such as Label, Device ID, Firmware Version, Zone, and parent Bridge.

Profile & Scene Report: Creates a printable report describing the configuration of all profiles and scenes currently in the system.

Device Settings Report: Creates a printable report describing the default settings for all nLight devices in the system.

Global Channels / Preset Report: Creates a printable report listing all configured Global Channels along with the devices broadcasting and tracking within them. Also listed is all Global Preset configurations saved to any Global Preset capable device.

Discovery Report: Creates a printable report listing basic discovery statistics about all nGWY devices in the system. This is generally used for diagnostic purposes only.

BACnet Inventory Report: Creates a CSV report that lists all BACnet devices available in the system. It lists the Instance Numbers for all BACnet devices, as well as the instance values for all available properties. This is typically provided directly to the BACnet integrator.

Devices

On the SensorView Overview Device Properties page the user selects from the device tree. By default these devices are listed in hierarchical order: gateways are parents of bridges, which are parents of zones, each of which contain sensors, switches, relays, dimmers, or other devices.

Gateway Properties

The screenshot shows the 'Gateway Properties' page in the nLight Network software. The left sidebar contains a tree view of the network hierarchy, with 'Upstairs Gateway' selected. The main content area features a 3D model of the gateway device. Below the model, there are two sections: 'Basic info' and 'Advanced details'. The 'Basic info' section includes fields for ID (000003FC), Firmware Version (F194D0012-008 / F194D002E), Label (Upstairs Gateway), and Notes. The 'Advanced details' section includes IP (10.65.67.52), Device Count (GW: 136 DB: 136 Offline: 0), Discovery (Device count: 136, Completed: 9/16/12 6:47:05pm, Duration: 5.984 seconds, Gateway time: 9/16/12 6:55:42pm), Date Code (0208), Ntp Server (64.90.182.55), and Associated Profiles (Scott Test, Jim's office, Sample Profile 1, Test #2, Jarrod's Schedule 1, Test_manny).

Note that some items on Properties pertain only to certain types of devices and do not appear otherwise.

Basic Info:

- **ID:** An unique ID assigned to the device.
- **Firmware Version:** Indicates the firmware currently installed and running on the device. If this number does not match information in the Overview screen under “**Updates**”, it may be time for a [firmware update](#).
- **Label:** This custom label should be used to describe and represent the device.
- **Notes:** (optional) Comments on this device or the area it serves.
- **Load: (in Watts)** Shows and/or sets the load on the selected device or devices within the selected zone; used with Green Screen. Only applicable to devices containing relays or nIO LEDs.
- **Update Historical Load Data:** This indicates whether to change the load for data points previously collected for Green Screen (when checked) or leave old load values unaltered (unchecked). Only applicable to devices containing relays or nIO LEDs.

Advanced detail

- **IP:** The IP address of the selected gateway. nGWY only.
- **Device Count:** Shows the number of devices beneath this gateway in the network, including its bridges and all devices below them. DB shows the number of database records associated with the selected gateway, which should match the number of devices. Most SensorView users may ignore this data, which is primarily used for network and system diagnostics. Also indicated are the number of devices *offline*, if any. nGWY only.
- **Discovery:** Indicates the last time the selected Gateway was polled by SensorView. This occurs when an instruction to the device is sent by a SensorView user, or a firmware update. You can perform discovery any time by clicking **Rediscover**. nGWY only.
- **Date Code:** Indicates the internal lot number for the device.
- **NTP Server: Network Time Protocol (NTP)** is a protocol for synchronizing the clocks of computer systems over a network. This is used to keep times on gateways in sync, and the NTP server's IP address is listed here. nGWY2 only.
- **Parent Gateway:** The name of the Gateway directly above the selected bridge in the network hierarchy.
- **Network Depth:** The number of steps below a gateway in the network hierarchy.
- **Associated Profiles:** Profiles which include the selected device.
- **Zone:** The name of the Zone in which the selected device resides.
- **Parent Device:** The name of the device above the selected zone in the network hierarchy.
- **BACnet Instance (Number)** A device's instance number is used to uniquely identify nLight devices connected to BACnet.

The instance number is combined with other parameters in BACnet, such as Object Type or Object Name. Because BACnet services many facilities and many different companies, the instance number compensates for and eliminates any possibility of duplicate identifiers across the BACnet network. It is similar to the WHOIS function for domain names on the Internet. Requesting devices across the network can identify the device, its address information and its relative position in the network hierarchy. More information on [BACnet Instance Numbers](#).

Output Controls

Provides convenient controls for viewing the current status of the device, as well as modifying the device's outputs (relays or dimmers as appropriate).

Health

This section provides diagnostics read-outs for nLight Engineers and Field Techs.

Control Channels

nLight Devices exchange control information via the use of Local and Global channels. Communication performed within a Zone (single nBRG port) is dictated via Local Channels; while Global Channels allow a device to receive input from any other device on the nLight network.

SensorView allows users to modify both Local and Global Channels to configure the control they need. Local Channels are commonly used to subdivide a single Zone and allow for switches to control individual fixtures or switch legs within a Zone, rather than all of them. Global Channels are more commonly used to provide instantaneous switch control over the entire building with a master switch.

Channels, both Global and Local, can be used to fine tune the control that one devices has over others, for Occupancy, Switching, and Daylighting.

Local Channels

SensorView's **Local Channels** tab allows a user to specify the channeling for all devices in the selected zone. Users can configure **Switching**, **Occupancy**, and **Photocell** channels on a single screen.

Devices tracking a particular channel will respond to commands sent by any device broadcasting on that channel. To configure one device to control another simply set the broadcasting and tracking numbers for the devices to the same number. The column on the far right is a combined view, indicating all devices broadcasting and tracking on the same channel, as changes are made this column will update.

The screenshot shows the 'Control Channels' interface in the nLIGHT SENSORVIEW application. The interface is divided into three main sections: 'Switch', 'Occupancy', and 'Photocell'. Each section has a 'Broadcasting' table and a 'Tracking' table. The 'Channel 1' and 'Channel 2' panels on the right show the combined view of devices broadcasting and tracking on those channels.

Switch	Occupancy	Photocell																								
<table border="1"> <thead> <tr> <th>Broadcasting</th> <th></th> </tr> </thead> <tbody> <tr> <td>nIO next to door:</td> <td>1</td> </tr> <tr> <td>nIO next to door:</td> <td>1</td> </tr> <tr> <td>nIO over desk:</td> <td>1</td> </tr> <tr> <td>nIO over desk:</td> <td>1</td> </tr> <tr> <td>nPODM DX WH (001A454C):</td> <td>1</td> </tr> </tbody> </table>	Broadcasting		nIO next to door:	1	nIO next to door:	1	nIO over desk:	1	nIO over desk:	1	nPODM DX WH (001A454C):	1	<table border="1"> <thead> <tr> <th>Tracking</th> <th></th> </tr> </thead> <tbody> <tr> <td>nIO next to door:</td> <td>1</td> </tr> <tr> <td>nIO next to door:</td> <td>1, 2</td> </tr> <tr> <td>nIO over desk:</td> <td>1</td> </tr> <tr> <td>nIO over desk:</td> <td>1</td> </tr> <tr> <td>nPP16 (00001E34):</td> <td>1</td> </tr> </tbody> </table>	Tracking		nIO next to door:	1	nIO next to door:	1, 2	nIO over desk:	1	nIO over desk:	1	nPP16 (00001E34):	1	<p>Channel 1</p> <p>Br: nIO next to door nIO next to door nIO over desk nIO over desk nPODM DX WH (001A454C)</p> <p>Tr: nIO next to door nIO next to door nIO over desk nIO over desk nPP16 (00001E34)</p> <p>Channel 2</p> <p>Br: <input type="text"/></p> <p>Tr: nIO next to door</p>
Broadcasting																										
nIO next to door:	1																									
nIO next to door:	1																									
nIO over desk:	1																									
nIO over desk:	1																									
nPODM DX WH (001A454C):	1																									
Tracking																										
nIO next to door:	1																									
nIO next to door:	1, 2																									
nIO over desk:	1																									
nIO over desk:	1																									
nPP16 (00001E34):	1																									
<table border="1"> <thead> <tr> <th>Broadcasting</th> <th></th> </tr> </thead> <tbody> <tr> <td>nCM PDT 9 (00000D45):</td> <td>1</td> </tr> </tbody> </table>	Broadcasting		nCM PDT 9 (00000D45):	1	<table border="1"> <thead> <tr> <th>Tracking</th> <th></th> </tr> </thead> <tbody> <tr> <td>nIO next to door:</td> <td>1</td> </tr> <tr> <td>nIO next to door:</td> <td>1</td> </tr> <tr> <td>nIO over desk:</td> <td>1</td> </tr> <tr> <td>nIO over desk:</td> <td>1</td> </tr> <tr> <td>nPP16 (00001E34):</td> <td>1</td> </tr> </tbody> </table>	Tracking		nIO next to door:	1	nIO next to door:	1	nIO over desk:	1	nIO over desk:	1	nPP16 (00001E34):	1	<p>Channel 1</p> <p>Br: nCM PDT 9 (00000D45)</p> <p>Tr: nIO next to door nIO next to door nIO over desk nIO over desk nPP16 (00001E34)</p>								
Broadcasting																										
nCM PDT 9 (00000D45):	1																									
Tracking																										
nIO next to door:	1																									
nIO next to door:	1																									
nIO over desk:	1																									
nIO over desk:	1																									
nPP16 (00001E34):	1																									

Start by selecting a zone from the tree. Then configure channels (eg. make this switch control only the lights at the back of the room) change the broadcasting channel of one or more devices to a new number, and add that number to the tracking channels of one or more devices the broadcaster(s) should affect. Add or remove tracking channels by expanding a drop-down and checking or unchecking the

desired channels. Note that as changes to the channels are made the far right column will update to indicate which devices are tracking/broadcasting on each channel.

Global Channels

With traditional wired nLight systems, devices within a zone communicate occupancy, photocell and switch events over local channels.

With global channels, communication of this information is possible between zones as well. This provides enhanced design flexibility for applications requiring master control stations or centralized relays. Global channels are set through SensorView.

Select desired Switches from the Tree menu, and Select Switch on the Global Channels screen, and select the Global Channel on which the desired devices will operate. Click to add desired Switches (devices) to this

If no channel is yet defined, select New Channel. SensorView will display the next available Global Channel.

Devices can be added to more than one channel if desired. Click New Channel to see the next available Global Channel.

nWiFi Global Channel Functionality

Out of the box nWiFi devices communicate with other devices directly connected to them, but when configured can use the WiFi network and global channels to link to other devices wirelessly and communicate switch, occupancy, and/or photocell events.

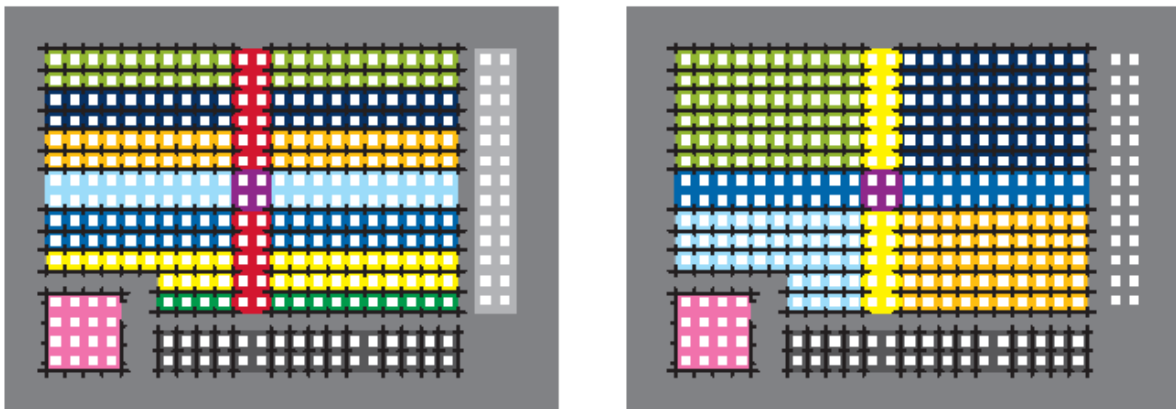

EXAMPLE: Warehouse with multiple global channel assignments per device

For example, a common global channel would be tracked by devices within each colored area above. On/Off & Dim Level control of each area is then possible via a standard WallPod. nWiFi devices can be set to track any/all of the 128 global channels – providing the flexibility to assign each device into

multiple groups based on its location or type (i.e., All Rows, Columns, Alternating, Load Shed eligible, Custom, etc.). Simultaneous On/Off & Dim Level control of multiple global channel groups (referred to as “global preset”) is possible via a Scene Selector WallPod.

nWiFi Global Commands

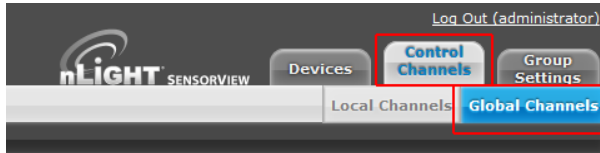

To create groups of devices that will switch on and off together, click on the Control Channels tab at the top right of the page followed by the Global Channels tab. The tree will expand and display all of the devices that can broadcast and track events over the nWiFi network.



Any Global Channels that have been previously assigned will be displayed. A maximum of 128 Global Channels are available. To view or edit the devices that are part of a global channel expand the channel by clicking the arrow next to the channel name. Click the box under Broadcasting Devices or Tracking Devices to add or remove devices from that group using the device tree.



After setting up the desired channels, click Finish followed by **Save Global Channels**.

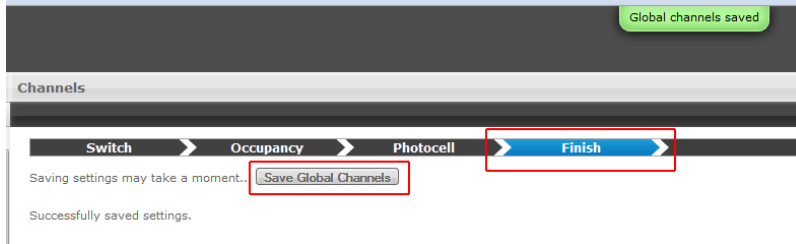

To create a new Global Channel click the New Channel button, change the default label if desired, and select Broadcasting or Tracking to begin adding devices from the tree.



To select (or deselect) multiple devices at once in the tree click the box next to a top-level device, such as a gateway or nLight Config Tool, to affect everything below it.

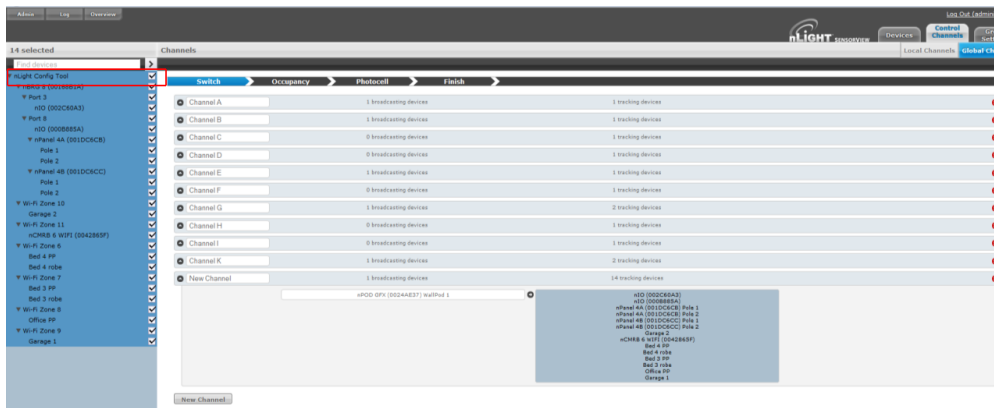

Tip: Channels used in a global preset shouldn't contain the same devices to prevent On/Off conflicts. e.g., a preset where 50% of all lights go on and the other half go off, two global channels are required (one for the On command & the other for Off).

Global Preset: a combination of global channels commands (on/off/dim level) activated simultaneously by a device. Each global preset can feature different commands on different channels. A global preset can contain between 1 and 80 Global Channels.

For example: a Scene Selector can simultaneously send an On command to all devices tracking global channel A and an Off command to all devices tracking global channel B.

To set a Global Preset on a Graphic WallPod (nPOD GFX), find the device in the tree on the Devices page and click the Scenes tab.

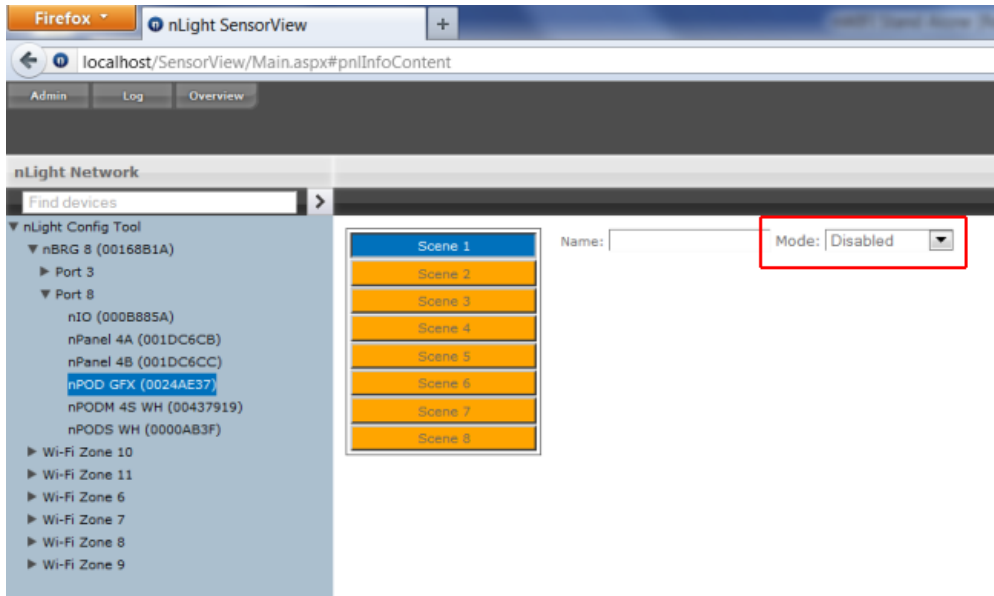

Change the mode to Global Preset **Mode: Global Preset** and select the desired global channels. Once they have been selected set them to On, Off, or a Dim Level (if dimming hardware is installed) and click Save.

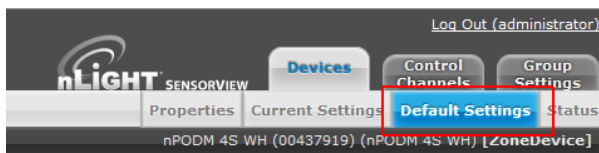
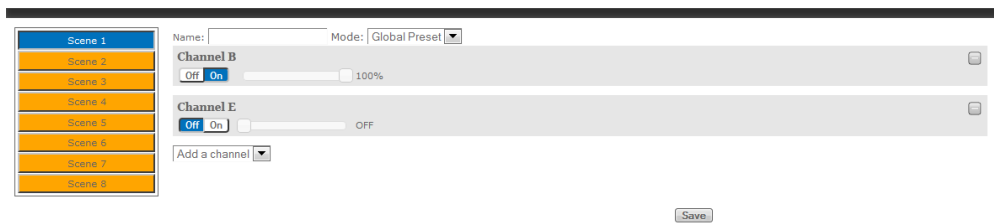

To set a Global Preset for an nPOD(M) device, find device in the tree on the Devices page and select the Default Settings tab near the top right of the page.

Change the mode to Global Preset and select the desired global channels. Once selected set them to On, Off, or a Dim Level (if dimming hardware installed) and click Save.

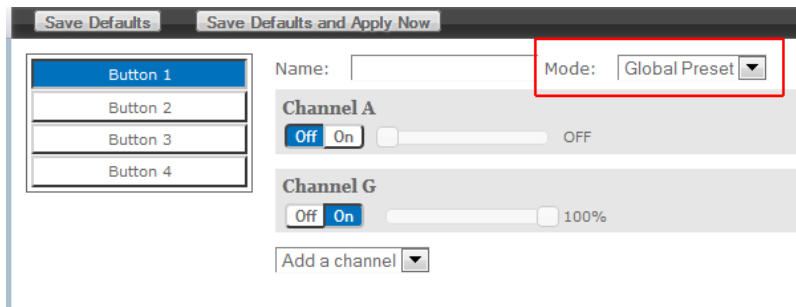

Global Presets are resent every time the button on the device is pushed; if any fixture(s) does not respond to the Global Preset, resend by pressing the button again.

Group Settings

Here default settings can be modified for many devices at once. Start by selecting devices from the tree, which will show a drop-down to add a setting. The list of settings available depends on the devices selected.

Add one or more settings, then select the desired value(s). When finished, click Save Defaults.

Selecting Multiple Devices from the Tree

MultiSelect is a selection mode offered by SensorView's tree. When operating in this mode, all line items displayed in the tree will be given a checkbox which will allow for selection. Single clicking on a device no longer displays information specific to the device, but rather selects/deselects it.

This mode of selection is used when large amounts of devices are to be operated on simultaneously.

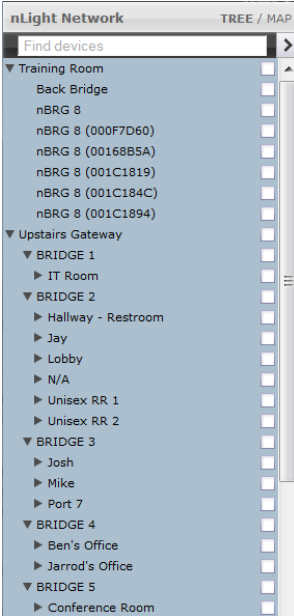
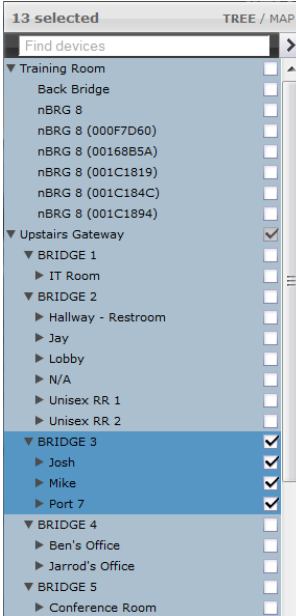
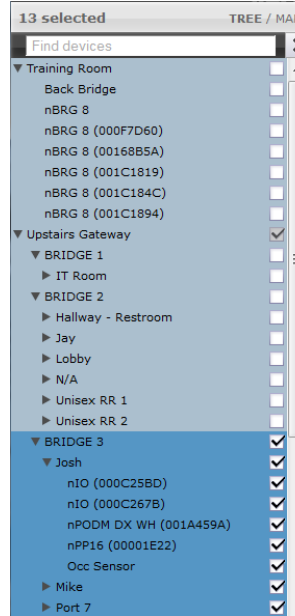
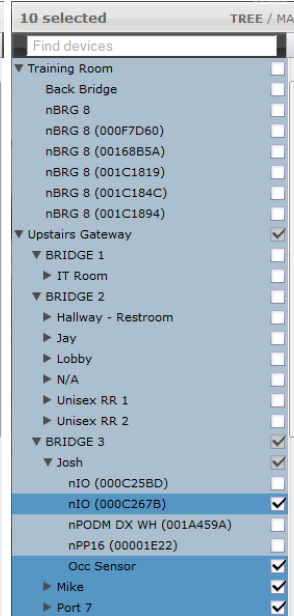
<p>None Selected (empty Checkboxes)</p>	<p>Bridge Selected (Parent gateway checked in gray)</p>	<p>Zone expanded. All zone devices checked</p>	<p>Specific zone devices unchecked</p>
			

Selecting a zone device (a device that exists in a zone) only selects/deselects that device. Selecting a zone, bridge, or gateway selects/deselects children; this allows for a user to quickly select all devices in a zone, bridge, or gateway.

Profiles



The **Profiles** tab is where control modes and settings for a particular group are selected. A schedule (complete with a recurrence pattern) and priority are also chosen on this page.

Profiles are stored in the database and the Gateway, which administers profiles according to priorities. The profiles can also be activated on demand via SensorView or the Gateway.

Click New to start creating a new profile, or the name of a profile in the list to edit an existing profile.

Add or remove devices using the checkboxes in the tree on the left. Checked devices can participate in the profile and receive applicable settings while the profile runs.

Scheduler

- Schedule date/hour/minute for any setting change or control mode
- Astronomical start/end dates include +/-180 minute deviance from Sunrise/Sunset
- Set daily/weekly/monthly/yearly recurrences; drilldown options provide more detailed patterns

Priority:

- Select the priority of the profile to change, then use the arrows to move to the appropriate position, or down into the disabled area

Unlike other systems which allow scheduling of lights on/off or on-demand dimming scene control, nLight provides users with the ability to schedule changes to almost any operational parameter. This allows for dynamic sequences of operation that can be tailored to a space across different times of day and/or dates.

Schedules

The **Schedules** tab shows all scheduled profiles for zones and devices in the nLight network, on a 24-hour schedule for a given date.

Hovering over a profile name displays the profile's begin and end times. Clicking the profile name is a shortcut to editing that profile on the Profiles tab.

When a zone is expanded, individual schedule bars for the zone's devices are generated. These bars are colored to denote a specific profile.

Clicking the header with the time markings will bring up a date picker for quick viewing of a future date.

Users

The Users tab manages users and their permissions to nLight devices and Virtual WallPods.

At the top, under User Accounts, is a drop-down that lists users. Select a user to display and edit the user's details.

You may assign one or more **Virtual Switches** to a user by clicking **Add Switch**. The newly added switch can be labeled using the text field. Select either **Zone Channel** or an **Individual device** from the Control Type drop-down.

For zone channel switches **Select Zone** from the drop-down. Individual devices associated with that zone will be displayed beneath. For individual device **Select device to control**, and it will be added to your list.

When finished click **Save**.

Adding, Modifying, and Deleting Users

To add a user select **Add a user** from the drop-down. Or select a username to edit that user. Clicking **Delete user** will delete the user selected in the drop-down.

Users you control, other than yourself, can be one of several user types, which dictates their level of capabilities within SensorView.

- **Read-only** users are only allowed to view status and current settings from the devices they are given permission to; they are not allowed to affect any sort of change to the system.
- **Basic** users are allowed to read and configure the devices within their permissions, including managing profiles for (just) those devices.
- **Administrators** have access to the Admin page. In addition to Basic User tasks for their permission set, Administrators are also allowed to run updates and manage SensorView (location, gateway passwords, mail servers, and users).

SensorView Terms

- ❖ **100 Hour Burn-In:** Overrides relay on and/or dimming output to full bright (typically used for lamp seasoning)
- ❖ **Auto Set-Point:** Photocell calibration procedure for detecting optimum lighting control level
- ❖ **Auto to Override On:** Special Mode where lights are turned on initially by occupant detection but then left in the Override On state
- ❖ **BACnet Instance (Number)** A device's instance number is used to uniquely identify nLight devices connected to BACnet.

The instance number is combined with other parameters in BACnet, such as Object Type or Object Name. Because BACnet services many facilities and many different companies, the instance number compensates for and eliminates any possibility of duplicate identifiers across the BACnet network. It is similar to the WHOIS function for domain names on the Internet. Requesting devices across the network can identify the device, its address information and its relative position in the network hierarchy. More information on [BACnet Instance Numbers](#).

- ❖ **BMS (Building Management System)**

A Building Management System (BMS) is a network which monitors and/or controls devices in a building, campus, or in multiple facilities.

When used for **monitoring**, the BMS polls and displays information from various types of equipment. BMS may monitor alarm conditions for equipment dependent up humidity or temperature. SensorView polls nLight devices, for example, and collect sensor information on occupancy, light levels, microphonic activity, among others.

When used as a control system, the BMS has the ability to change settings on networked devices. This can be done manually by facilities/BMS managers, or by pre-programmed conditions, where settings of devices are modified in response to readings collected by other networked devices. Slave devices pass data from sensors to the master, which processes collected data and issues instructions for any necessary settings changes. Instructions can also be issued to devices based on Profiles which may be scheduled to start at a certain time of day, or triggered by readings and thresholds of other devices. nLight products integrate with BMSs using Internet protocols and open standards such as BACnet.

- ❖ **Broadcast Analog Input:** Input mode that senses a 0-10 VDC input
- ❖ **Button Mode:** Overrides a device and enables its push-button to toggle the device's internal relay(s) or dim level
- ❖ **Dimming Offset:** Fixed voltage difference of dimming output from dimming photocell

- ❖ **Dimming Rate:** The speed at which automatic changes to the light level occur
- ❖ **Dual Technology (Microphonics):** A second method of occupancy detection that allows the sensor to hear occupants
- ❖ **Dual Zone Fan Mode:** Dual Zone photocell mode where Zone 2's photocell control is disabled
- ❖ **Dual Zone Off-Point:** Zone 2's set-point as a percentage of Zones 1's set-point (Dual Zone photocell applications only)
- ❖ **Dual Zone Offset:** Fixed voltage increase of Zone 2's dimming output from Zone 1's dimming output (Dual Zone photocell applications only)
- ❖ **Dual Zone Offset Mode:** Dual Zone photocell mode where Zone 2's set-point is a selected percentage higher than Zones 1's set-point
- ❖ **DZ Photocell Mode:** Indicates a Dual Zone photocell sensor's method of operation
- ❖ **Enabled – Both Positive and Negative:** User can increase or decrease lighting level set by dimming photocell
- ❖ **Enabled – Negative Only:** User can decrease lighting level set by dimming photocell
- ❖ **Follow Photocell Mode:** Instructs how a device's dimming output reacts relative to a dimming photocell
- ❖ **Idle Time Until Dim:** The length of time after last detected occupancy that a sensor will reduce lighting to unoccupied dim level.
- ❖ **Incremental Set-Point Adjust:** Alters the target light level that is to be maintained by the device (in footcandles)
- ❖ **Invert Relay Logic:** Reverses functionality of relays
- ❖ **LED:** Indicates the behavior of a device's LED
- ❖ **Local Only Occupancy Tracking:** Instructs a device with a relay and/or dimming output to react to only its internal occupancy information
- ❖ **Local Only Photocell Tracking:** Instructs a device with a relay and/or dimming output to react to only its internal photocell information
- ❖ **Local Only Switching Tracking:** Instructs a device with a relay and/or dimming output to react to only its own manual switching and/or dimming events
- ❖ **Manual On to Full Auto:** Special Mode that initially requires the occupant to manually turn on the lights, after which the sensor assumes full on/off control
- ❖ **Manual to Override On:** Special Mode that requires the occupant to manually turn on the lights and then leaves them in the Override On state
- ❖ **Microphone Grace Period:** The time period after lights are automatically turned off that they can be reactivated by sound
- ❖ **Momentary:** Input mode that senses a pulse style switch
- ❖ **Night Light Brightness:** The percent of full brightness the push-buttons LED illuminates
- ❖ **Network Time Protocol (NTP)** is a protocol for synchronizing the clocks of computer systems over a network. nLight gateways are synchronized with an NTP Server.
- ❖ **Occupancy Broadcast Channel:** The channel on which a sensor transmits its occupancy information
- ❖ **Occupancy Broadcasting:** Indicates whether a sensor will transmit its occupancy information to the rest of its zone



- ❖ **Occupancy Tracking:** Indicates whether a device's relay and/or dimming output will react to occupancy information
- ❖ **Occupancy Tracking Channel:** The channel on which a relay and/or dimming output receives occupancy information
- ❖ **Occupied Bright Level:** The output level (0-10 VDC) that a dimming sensor sets the lights when occupancy is detected (not applicable if photocell is enabled).
- ❖ **Override:** Indicates whether a device's relay is forced on/off and/or dimming output is forced to maximum/minimum
- ❖ **Photocell Broadcast Channel:** The channel on which a sensor transmits its photocell information
- ❖ **Photocell Broadcasting:** Indicates whether a sensor will transmit its photocell information to the rest of its zone
- ❖ **Photocell Dimming Range (High):** The maximum output level (0-10 VDC) up to which an automatic dimming photocell will control
- ❖ **Photocell Dimming Range (Low):** The minimum output level (0-10 VDC) down to which an automatic dimming photocell will control
- ❖ **Photocell Mode:** Indicates a photocell sensor's method of operation. One mode enables the sensor to turn the lights both on and off while the other mode can only inhibit (prevent) the lights from turning on
- ❖ **Photocell Tracking:** Indicates whether a device's relay and/or dimming output will react to photocell information
- ❖ **Photocell Tracking Channel:** The channel on which a relay and/or dimming output receives photocell information
- ❖ **Photocell Transition Off Time:** The time period for which a photocell must measure a light level above the set-point before it will turn the lights off
- ❖ **Photocell Transition On Time:** The time period for which a photocell must measure a light level below the set-point before it will initiate the lights on
- ❖ **Predictive Exit Time:** The time period after manually switching lights off for the occupant to leave the space (Predictive Off mode only)
- ❖ **Predictive Grace Period:** The time period after the Predictive Exit Time that the sensor rescans the room for remaining occupants (Predictive Off mode only)
- ❖ **Predictive Off:** When lights are switched off, this Special Mode determines whether occupants remain or left the room, so as to leave the lights in either the Override Off or Auto On state.
- ❖ **Profile Mode:** Mode that commands a Gateway to run any number of specified profiles
- ❖ **Profile Override:** Whether profiles selected via a Scene Controller button will cancel out or run concurrently with other profiles.
- ❖ **Reduced Turn-On:** Reduces the initial PIR detection strength; for use in areas where reflections are in sensor's view
- ❖ **Scene Expiration Time:** The length of time a selected scene or profile will run before automatically disengaging and reverting affected devices back to defaults

- ❖ **Scene Mode:** Mode that causes button to initiate pre-programmed settings on devices within a local zone
- ❖ **Scene Mode – Momentary:** Mode where pre-programmed settings are run on devices within a local zone when a pulse style switch is sensed from the connected device
- ❖ **Scene Mode – Toggle:** Mode where pre-programmed settings are run on devices within a local zone when an open/close style switch is sensed from the connected device
- ❖ **Semi-Auto:** Special Mode that requires the occupant to manually turn the lights on, while having them turn off automatically by a sensor
- ❖ **Semi-Auto Grace Period:** The time period after lights are automatically turned off that they can be reactivated with movement
- ❖ **Set-Point:** The target light level that is to be maintained by the device (in foot-candles)
- ❖ **Special Modes:** Unique defined behaviors for relays and/or dimming outputs
- ❖ **Start-to-High:** Lights go to full bright for 20 minutes upon initial power up
- ❖ **Stepped Dimming (DUO) Mode:** Dual Zone photocell mode where the appropriate on/off combination of the two associated relays is maintained in order to always meet the photocell set-point requirements
- ❖ **Stepped Dimming (DUO) – Never Off:** Dual Zone photocell mode where the appropriate on/off combination of the two associated relays (except both off) is maintained in order to always meet the photocell set-point requirements
- ❖ **Sunlight Discount Factor:** Value used to improve the tracking accuracy of a photocell during periods of high daylight; decreasing the value will lower the controlled level of the lights
- ❖ **Sweep Exit Time:** The time period before a sweep is executed, setting time delays on affected devices to zero
- ❖ **Sweep Grace Period:** The time delay before a sweep is executed, so a user pressing a switch to activate the sweep may exit the room or building before the sweep occurs
- ❖ **Sweep Mode:** Mode that causes a Scene Controller button to set the remaining time delay for all devices on a gateway
- ❖ **Sweep Mode – Momentary:** Mode that sets the remaining time delay for all devices on a gateway when a pulse style switch is sensed from the connected device
- ❖ **Sweep Mode – Toggle:** Mode that sets the remaining time delay for all devices on a gateway when an open/close style switch is sensed from the connected device.
- ❖ **Switch Broadcast Channel:** The channel on which a device with a manual switch and/or dimmer transmits
- ❖ **Switch Broadcasting:** Indicates whether a device with a manual switch and/or dimmer will transmit events to the rest of its zone
- ❖ **Switch Tracking:** Indicates whether a device's relay and/or dimming output will react to manual switching or dimming events
- ❖ **Switch Tracking Channel:** The channel on which a relay and/or dimming output receives manual switching or dimming events







- ❖ **Timed Override Delay:** The length of time an Override On state that is initiated by a Special Mode will remain in effect
- ❖ **Toggle Mode:** Input mode of a nIO that senses an open/close style switch
- ❖ **Unoccupied Dim Level:** The output level (0-10 VDC) a dimming sensor sets the lights after the idle time until dim timer expires
- ❖ **WallPod Dimming Adjustments:** Indicates whether user adjustments to dimming levels are stored to device defaults (Permanent) or not (Temporary)
- ❖ **Wallpod Mode – Momentary:** Mode that creates an equivalent WallPod signal when a pulse style switch is sensed from the connected device.
- ❖ **Wallpod Mode – Toggle:** Mode that creates an equivalent WallPod signal when an open/close style switch is sensed from the connected device
- ❖ **WallPod Mode:** Mode that causes a Scene Controller button to function like a WallPod

Status Icons



Voltage Status

Icon	Value	Description
	Bridge / Transceiver PowerState Power Supply Voltage: (VDC)	Device has adequate power (bridge)
	Bridge / Transceiver PowerState Power Supply Voltage: (VDC)	Device is close to low power condition (bridge)
	Bridge / Transceiver Power State Power Supply Voltage: (VDC)	Device is in low power condition (bridge)









Broadcasting & Tracking Status

Icon	Value	Description
	Occupancy Broadcasting	Occupancy status broadcast is active
	Occupancy Tracking	Occupancy status tracking is active
	Photocell Broadcasting	Photocell status broadcast is active
	Photocell Tracking	Photocell status tracking is active
	Switch Broadcasting	Switch status broadcast is active
	Switch Tracking	Switch status tracking is active





Scenes & Profiles Status

Icon	Value	Description
	Scene States (per button/nIO) Scene State: Active	Scene associated with button is active
	Scene States (per button/nIO) Scene State: Idle	Scene associated with button is not active

SensorView Manual

	Scene States (per button/nIO) Scene State: Disabled	Button is disabled
	Scene Expiration Time	Indicates when current running scene/profile will expire
	Photocell Not Inhibiting	Indicates that photocell is not preventing lights from being on
	Photocell Status (per pole) Transition time: (hh:mm:ss)	Indicates when current photocell state will change
	Temperature	Current temperature at the processor of the device
	LightLevel Measured light level: (fc)	Current foot candle level as measured by the photocell
	Profile Active	Profile is currently active
	Profile Inactive	Profile is NOT currently active







Photocell Status

Icon	Value	Description
	Photocell Inhibiting	Indicates that photocell is preventing the lights from being on
	Photocell Not Inhibiting	Indicates that photocell is not preventing lights from being on
	Photocell Status (per pole) Transition time: (hh:mm:ss)	Indicates when current photocell state will change
	LightLevel Measured light level: (fc)	Current foot candle level as measured by the photocell







PIR & PDT Status

Icon	Value	Description
------	-------	-------------





SensorView Manual

	Time Delay Remaining: (hh:mm:ss)	Indicates when current occupancy state will expire
	Tracked Occupancy Timer	Reason why pole is open or closed
	PIR Activity	PIR Activity detected/detecting occupant motion
	PIR Activity	No PIR Activity. PIR not currently detecting occupant motion
	Microphonic Activity	Microphone has detected a triggering noise
	Microphonic Activity	Microphone is not currently detecting noises







Occupancy, Relay & Dimming Status

Icon	Value	Description
	Occupied	Room is occupied
	Vacant	Room is not occupied
	Dimming Output (input) level: (%)	Current % of 0-10 VDC scales
	Input Dim Level	Follow Photocell Level: 4.9% or Input Dim Level: 100%
	Pole State Reason	Reason why pole is open or closed
	Accumulated Hours	Accumulated Hours: 1272
	Compensated Output Level	Compensated Output Level: 0











SensorView Manual

		Pole State reason: Manual Switch Override Off
		
	Relay State (per pole)	Closed
	Relay State (per pole)	Open

Wireless Status

Icon	Value	Description
	Wireless Signal Strength: (1- 5)	Indicates wireless signal strength (higher is better)
	Wireless PAN ID	Wireless panel identification number
	Wireless Node ID	Wireless node identification number
	Wireless Channel: (11-26)	Indicates the wireless channel currently being used
	Wireless State:	Wireless States: <ul style="list-style-type: none"> • Normal • Validating the network • Searching for a network that is allowing joining • Creating a new network • Allowing joining • Cloning is happening in the system • Multiple SSI networks are allowing joining • Lost a remote device during OTA cloning • Wireless device is not responding
	Bridge Port Information	Port States: <ul style="list-style-type: none"> • Polling downstream devices • Upstream port • Commissioning tool connected • Polling downstream bridges
		

SensorView Manual

		<ul style="list-style-type: none"> • Error: Too many adds/deletes (reset bridge) • Error: Local loop • Error: Non-local loop • Error: Devices connected between bridges
		
		
		
		
		
		Number of downstream wireless Bridges and Transceivers
	Transceiver Port Status	<p>Port States:</p> <ul style="list-style-type: none"> • Polling downstream devices • Upstream port • Commissioning tool connected • Polling downstream bridges • Error: Too many adds/deletes (reset bridge) • Error: Local loop • Error: Non-local loop • Error: Devices connected between bridges
		
		Number of downstream wireless Bridges & Transceivers

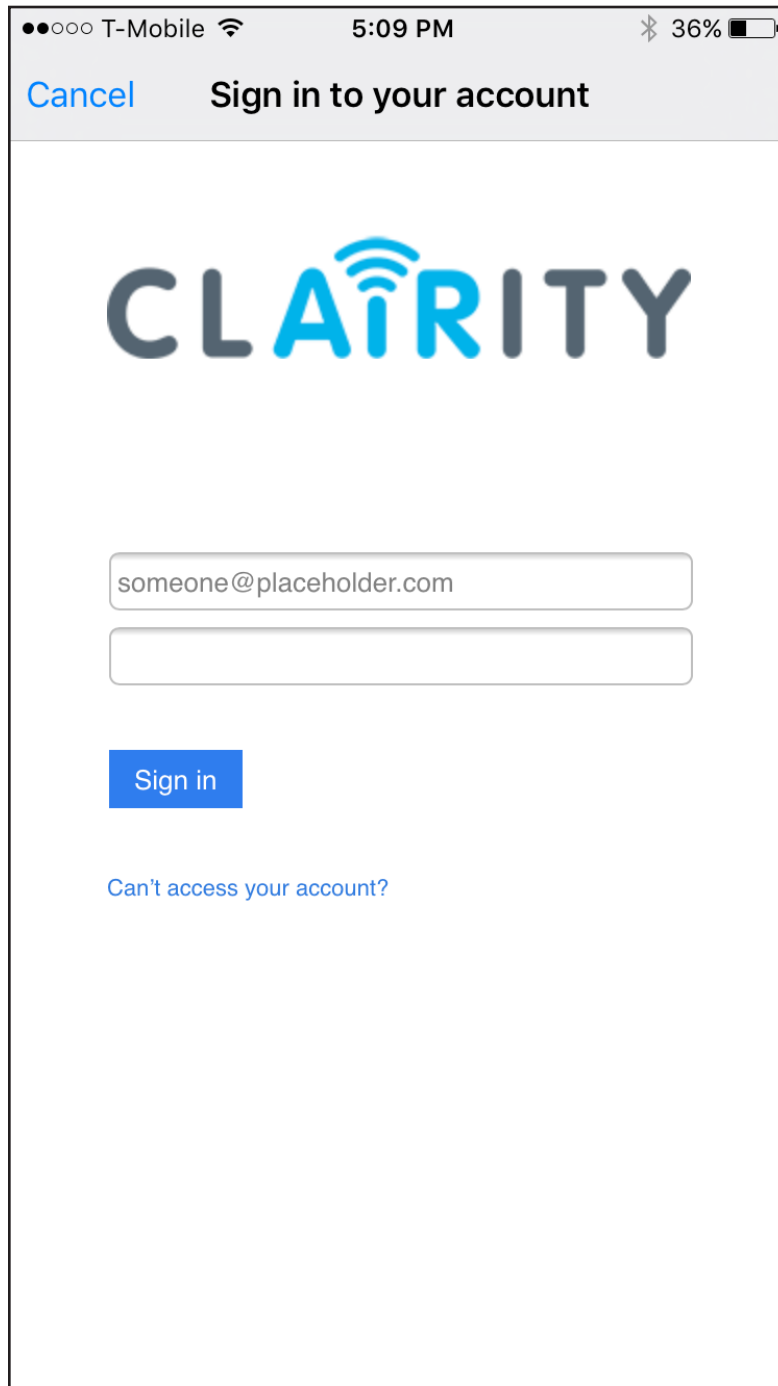

Clairity Pro Mobile App User Guide

Welcome to the Acuity Controls Clairity Pro mobile app, optimized to quickly and easily startup nLight® AIR lighting control solutions. Clairity Pro is available for both Android™ and iOS devices. This guide explains all the features and functionality within the Clairity Pro mobile app.

Table of Contents

Startup Process Overview.....	4
Out of Box Functionality.....	4
Download Clairity Pro.....	5
Enable Bluetooth on Your Mobile Device.....	5
Create a User Account.....	6
Forgot my Password.....	6
Sign into the App.....	6
Support.....	7
Saving and Retrieving Site Information.....	7
Recent Sites Screen.....	8
Create a New Site.....	8
Search for an Existing Site.....	8
Edit an Existing Site Name or Address.....	9
Create a New Group.....	9
Search for an Existing Group.....	10
Edit an Existing Group.....	11
Discovering New nLight AIR Devices & Adding Devices to a Group.....	12
Moving Devices on the Grid.....	14
Removing Devices from the Grid.....	14
Commissioning an nLight AIR Adapter.....	15
Associate a Group with an nLight AIR Adapter.....	16
Move a Group from one nLight AIR Adapter to Another.....	16
Making Customer Requests a Reality.....	17
Adding Discovered nLight AIR Devices to a Zone.....	19
Changing which nLight AIR Devices are in an Existing Zone.....	20

Table of Contents, cont'd



Selecting a Behavior for a Zone.....	20
Behaviors Explained.....	21
Calibrating the Daylighting in an Area	22
Disable a Sensor.....	22
Setup Dual Zone Offset	23
Adjust Microphonics Sensitivity.....	23
High End and Low End Trim	24
Group Firmware Updates	25
Individual Device Firmware Updates.....	26
Site Access	27
Sharing Sites	27
Communication Architecture.....	27
Troubleshooting	28
Who to Call if You Have Questions	28
Updating Clarity Pro	29
Multiple Users on One Site.....	29
Reprogramming an Area.....	29
Whole Group Decommissioning.....	30
Physically Removing Equipment.....	30
Definition of Terms.....	31

Startup Process Overview



nLight® AIR consists of fixtures (with and without integrated radios), wall switches, and sensors. There are no communication wires between the devices. Installers and other onsite personnel use the Clarity Pro mobile app to define how these devices interoperate to achieve the result our customers request.

An overview of the startup process we recommend you follow is shown below.

NOTE

A definition of terms section is located near the end of this guide.

1. Install and energize the equipment. You can proceed to the next step once all nLight® AIR equipment has been installed in a given functional area of the building.
2. Download the Clarity Pro app (first time users must follow the steps to create a user account)
3. Create the site
4. Create the first group, identify devices, and associate with the grid
5. Create all zones
6. Set behaviors for each zone
7. Return to step 4 when you're ready to move to the next group

Out of Box Functionality

Prior to programming, the devices will operate in their out of box functionality:

- Indoor fixtures with integrated occupancy sensors - All operate independently, and have occupancy enabled. 7.5 minutes after vacancy, the lights will dim to their dim level. After 2.5 more minutes of no activity, the lights will turn off.
- Switches - Do not control any fixtures
- Other indoor fixtures - will turn on when powered.
- Outdoor fixtures - will turn on at night and turn off in the morning.

Download Clairity Pro



Start by downloading the Clairity Pro mobile app from the Apple store (Clairity Pro). The app is no charge.





Enable Bluetooth on Your Mobile Device

Once the app has downloaded, ensure that Bluetooth® is enabled on mobile device. If you're unsure, follow the steps below for either an Android or iOS device.

NOTE

Disconnect from any existing Bluetooth devices before commissioning.

For **Android** Devices:

1. Open your device's Settings menu. 
2. Under Wireless & Networks, touch Bluetooth.
3. Touch the switch to turn Bluetooth On or Off.
4. A Bluetooth icon  at the top of your screen will indicate when Bluetooth is turned on.

For **iOS** Devices:

1. On your iOS device, tap Settings > Bluetooth
2. Tap the switch to turn Bluetooth On
3. Once complete, look for the Bluetooth icon  in the status bar of your device

Create a User Account



If this is your first time using the Clarity Pro app, follow the steps below to create a new user account.

1. Download the Clarity Pro App
2. Tap on the Sign up link at the bottom of the sign in page
3. Enter your information, including your email address, what you'd like your password to be, first name, last name, and your display name.
4. Once complete, tap on the Send Verification Code button.
5. Check your email.
6. You will receive an email with a verification code.
7. Go back to the app and enter the verification code you received.
8. Click on the Create Button.
9. Sign into the app with your email and password (Figure 01.)

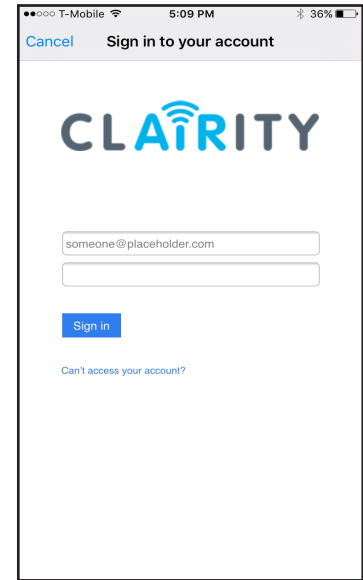

Figure 01: Clarity Pro Sign In

Forgot my Password

If you've forgotten your password, tap on the Can't Access My Account link just below the Sign In button. Follow the steps to reset your password.

Sign into the App

If you already have an account, use your email address and password to sign into Clarity Pro.

Once you've successfully signed in, you'll see the sync screen (Figure 02). While this screen is shown, the application is connecting to the cloud to retrieve your sites.

NOTE

You must have a connection to the Internet to complete this process.

NOTE

Users may only log into one mobile device at a time. If you use the same login on multiple devices simultaneously, the system will not program properly. If you need to use more than one mobile device, ensure each mobile device is using a different user name for the login credentials.

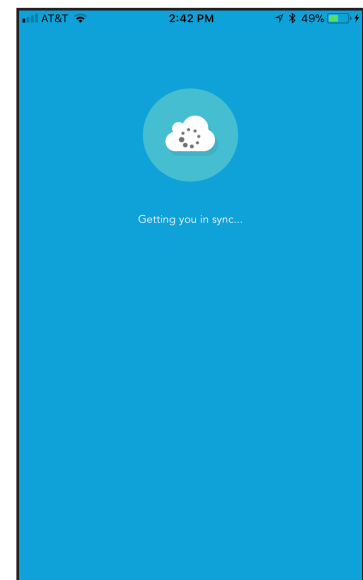

Figure 02: Clarity Sync Screen

Navigate to the support page from the sites screen by tapping on the question mark on the bottom right portion of the screen. The support page (Figure 03) provides contact information for Acuity Brands, a link to an instructional video, a link to a Quick Start Guide, and version information about the Clairity Pro app.

For new users we strongly recommend to view the Quick Start Guide and startup video to become familiar with the process and the app.

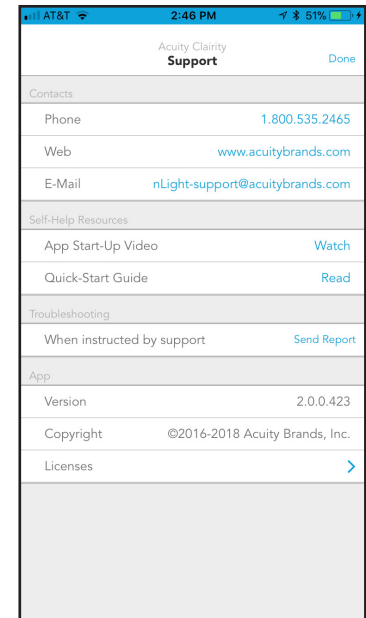

Figure 03: Support Page

Saving and Retrieving Site Information

Saving and retrieving previously saved sites in Clairity Pro is very easy. All the data you enter is saved in cloud-based servers for your future use. If you're not familiar with the cloud, that's OK – we take care of all the technical stuff behind the scenes. Just know that your data is very secure and is ready for your use when you need it. And, best part of the cloud, you can share the site with others (i.e. – others on your staff and/or the end user when the time comes).

As you make changes and proceed through the screens, information is saved either on your mobile device or in the cloud. In the event that you do not have a wireless or cellular connection to the Internet while making changes, no problem. Those changes are held within the app and pushed to the cloud as soon as you have a connection.

NOTE

All programming changes must be made in the immediate proximity to the area you are programming

NOTE

Internet connectivity is no longer required after this step.

Recent Sites Screen



After the app retrieves your sites from the cloud, it will display a list of those available to you. To work on a site, simply tap it in the list. If you need access to a site that you're not seeing in your list, please contact Acuity or contact the individual who has access to the site.

Create a New Site

To create a new site, follow the steps below.

NOTE

If you are adding equipment to an existing installation, you must add the equipment to the existing site if the design calls for the equipment to work together.

1. From the mobile app, navigate to the site screen (Figure 04) and click on the "+" at the bottom of the screen.
2. Enter the information about the site you're creating. The more information you enter, the easier the site will be to search for and find the site in Clarity Pro in the future. Site Name – the name of the site or project; It will typically be the name of the building in which you're working (e.g. – the White House). We recommend that you do not abbreviate to make it easier to find the site in the future. Organization / Company – The startup service provider should select the name of the customer (e.g. – The US Government)

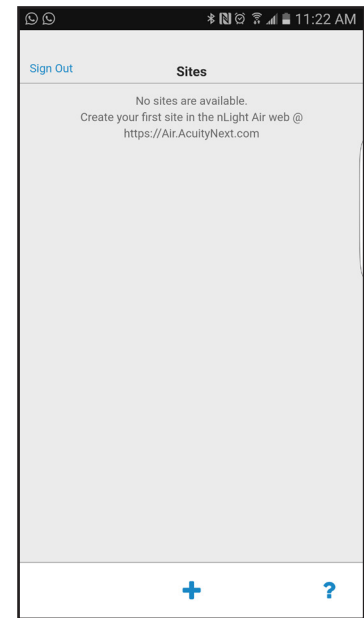

Figure 04: Sites Page - No Available

Search for an Existing Site

The Sites Screen will display all the sites to which the user can access. For some users who visit numerous sites, we have made it Select the site you need to access from the list of sites

NOTE

The search is not case sensitive.

Edit an Existing Site Name or Address



Site details can be edited from the Site Overview screen (Figure 05) by tapping on the information that needs to change, making the change, and tapping done when completed.

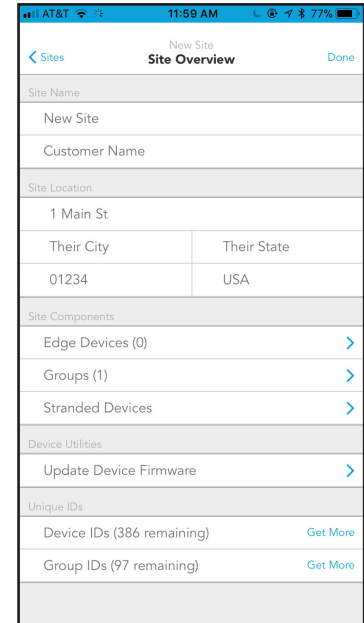

Figure 05: Site Overview

Create a New Group

Typically a group is created for each room. However, a group can not contain more than 127 devices.

To create a new group, follow these steps:

1. Tap on the "+" icon on the Groups screen (Figure 06).
2. Enter a name for the group. The group name is typically going to be the name of the room.
3. Tap the Create button
4. The list of groups will load.
5. Tap the group that you just created and the Group overview screen will load.

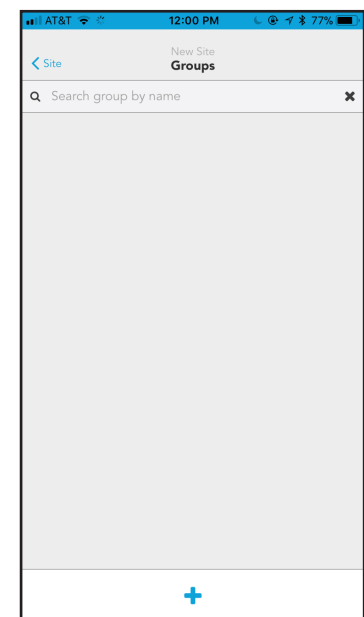

Figure 06: Groups

Create a New Group, cont'd



The Group Overview screen is used as a main landing point in the Clarity Pro app. It is the screen that allows for initial device identification, the creation of zones, and the assignment of behaviors.

To begin identifying devices and adding them to the grid, tap the devices link as shown in Figure 07..

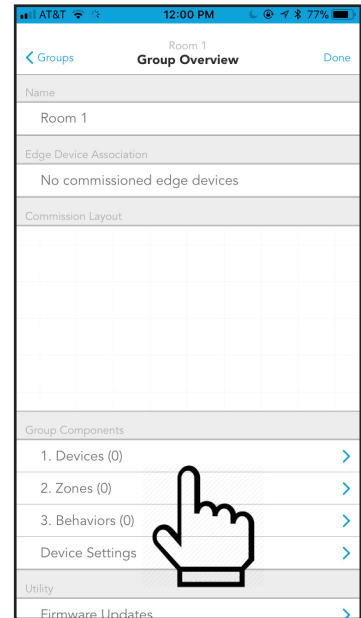

Figure 07: Group Overview

Search for an Existing Group

The Group Screen will display all the existing groups in the site. For large sites with many groups, we have made it easy to search for the group you need. To access the group search feature:

1. Navigate to the Groups Screen.
2. Enter the name of the group in the search bar at the top of the screen.
3. The list of groups that match your search criteria will update automatically
4. Select the group you need to access from the list of groups

NOTE

The search is not case sensitive.

Edit an Existing Group

The Groups screen shows all of the groups within a site.

To edit an existing group, select it from the list of available groups (Figure 08).

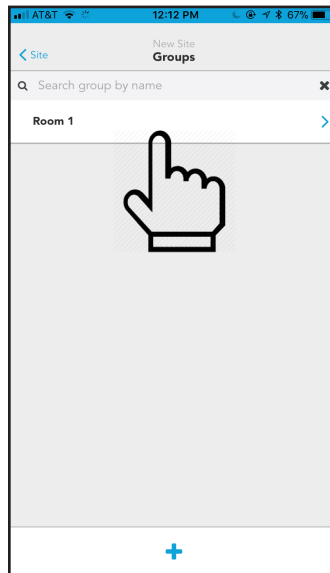

Figure 08: Groups Page

Modify the group details and tap done when completed (Figure 09).

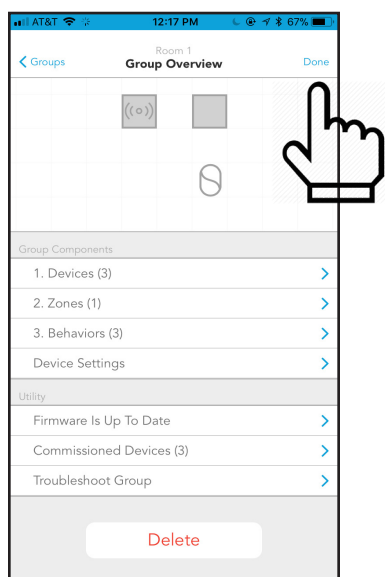

Figure 09: Groups Overview

Discovering New nLight AIR Devices & Adding Devices to a Group



To discover new nLight AIR devices, following the steps below:

1. From the Group Overview screen, tap the Devices link (Figure 10).
2. The Device Layout screen will open. Tap the "+" icon on the bottom left of the grid (Figure 11).
3. Select the type of device to add to the grid (Figure 12).
4. If you tap on the icon that looks like a light bulb, you'll enter a mode that allows you to layout the orientation and count of the fixtures and load controllers in the area. Similarly, if you tap on the switch, you'll enter a mode that allows for the addition of wall switches to the area. Finally, if you tap on sensors, you'll be able to add stand-alone sensors.
5. Once you've selected the type of device to discover, the Identified Devices screen will provide a list of nLight AIR devices, sorted by signal strength. If you do not see any devices in the list, ensure your mobile device's blue-tooth is turned on and make sure your in range of the devices (within about 60ft). Note: the list of devices has two views - those that are available and those that have already been assigned to the grid.
6. To identify a fixture, tap the identify button. Then look at the fixtures.
 - If you do not see one flashing on and off in the area, tap "hide" on that line. Note, it is very possible that you are flashing a fixture in an adjacent room. So, please take care in this identifying process. Hiding the device from the list will make the list much more manageable, especially if there are lots of devices on the site. If you hide the fixture, it will re-appear after you do a refresh of the list of nLight AIR devices.
 - If you see a fixture flashing in the area you are working in, tap the arrow to the right side of the green identify link. Doing so will load the grid so you can place the flashing fixture in its corresponding location.

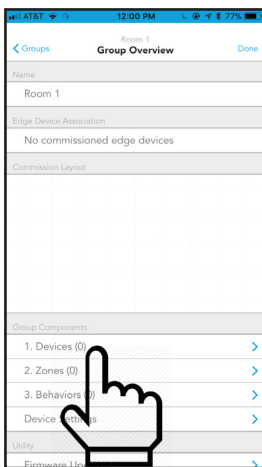

Figure 10: Groups Overview - Devices

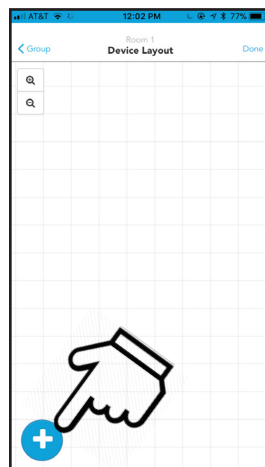

Figure 11: Device Layout

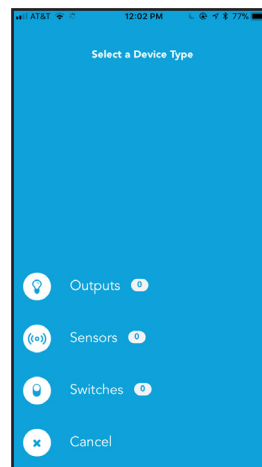

Figure 12: Select Device Type

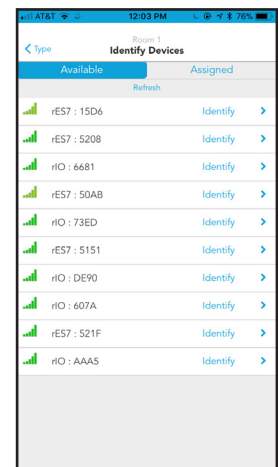

Figure 13: Identify Devices

Discovering New nLight AIR Devices & Adding Devices to a Group - cont'd



- To add the fixture to the grid, tap its relative position on the grid (Figure 14). Once the fixture has been added to the grid, it will not longer appear in the list of available devices. It will be added to the list of assigned devices. Once the fixture is added to the grid, you'll see the actual light level of the fixture change to a low light output. Use this as a way to track how many more fixtures need to be added to the grid from the room you're in.
- Continue this process until all fixtures in the area have been identified and added to the grid.

NOTE

A group may not contain more than 127 devices.

NOTE

If you're working in a large area, you may find it necessary to move around the area to see all the devices. The list of devices will not automatically refresh. If you've moved within the area, we recommend tapping the refresh button. The list will update to show you those devices that have the strongest signal strength for your present location. You can pan around the grid by dragging your finger across the grid. You may also zoom in and zoom out by using the +/- buttons or by pinching or spreading with your fingers on the screen.

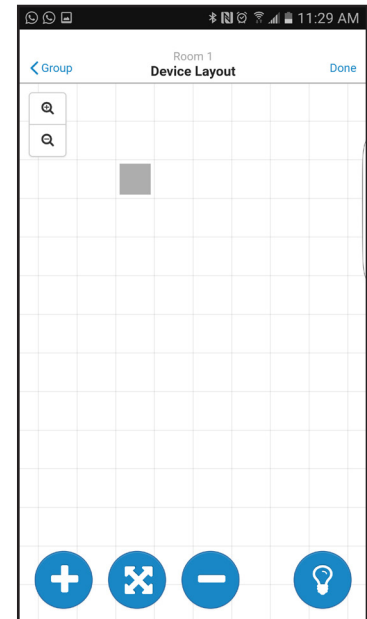
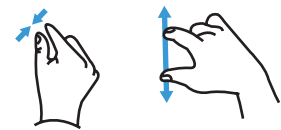

Figure 14: Device Layout - Grid



- Once you're ready to begin discovering wall switches, tap on the "+" button
- Choose the Wall Switch option on the Identify Devices screen.
- Press a button on the actual wall switch – the physical device on the wall. Battery powered devices will not remain in the list. They go to sleep after 1 minute of inactivity. Press any button on the switch to wake the device.
- After the button is pressed, you'll see a wall switch on the device screen.
- Press identify and validate that the LED's on the front of the switch begin flashing.
- Associate that device with its location on the grid by tapping on its relative position in the grid (Figure 15).
- If you have stand-alone sensors in the space, tap on the "+" button.
- Choose the sensor option on the identify devices screen.
- Press identify and validate the LEDs on the sensor blink (note - motion will also cause the sensor to blink. So, stand motionless below the sensor during this step).
- Associate that device with its position on the grid relative to the other devices.

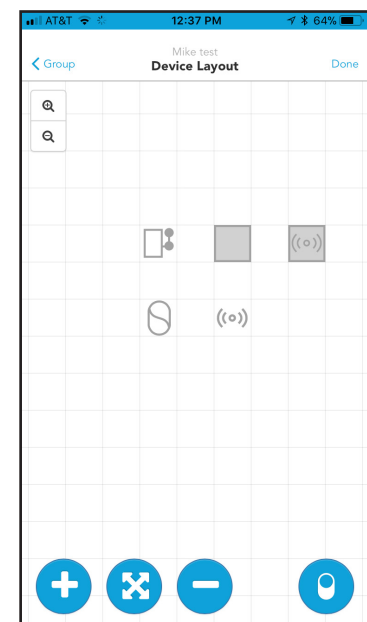

Figure 15: Device Layout - Wall Switch

Moving Devices on the Grid

1. To move a device on the grid, select the arrow button between the plus and minus buttons.
2. Select the device that needs to move by tapping it on the grid.
3. Select a new location for the device by tapping on the grid.

Removing Devices from the Grid

In the event a device needs to be removed from the group (whether it has been fully programmed or not), follow these steps:

1. Ensure you're physically located in the group.
2. Navigate to the group in the app
3. Open the Group Overview screen
4. Select "Devices".
5. From the grid view, select the '-' button at the bottom of the screen.
6. Tap on the device that needs to be removed.

NOTE

You must be located in the vicinity of the devices to perform this action.

Commissioning an nLight Air Adapter



To commission a new nLight AIR adapter, permanently mount the adapter. Do not commission the adapter before it is permanently mounted. Moving it can result in unstable RF connections to devices you've commissioned.

Once the adapter has been mounted and plugged into the Eclipse, allow 2 minutes before adding it to Clarity Pro. For the first 2 minutes, the Adapter is determining the clearest communication frequency to use. If you try to commission it to quickly after power on, Clarity Pro will provide you with a warning.

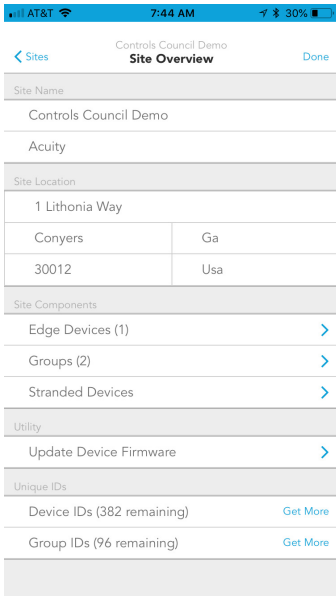

Figure 16: Site Overview

1. Navigate to the Site Overview screen (Figure 16).
2. Select Edge Devices (Figure 17).
3. Walk within about 30 feet of the Adapter you need to add.
4. Tap on the + to add a new Adapter.
5. Select the adapter from the list of available adapters.
6. Unless otherwise instructed by Technical Support, keep automatic mode enabled, and tap "Commission" (Figure 18).

If the project has more than one adapter, it is strongly recommended that you name the adapters. To do so, tap on it and rename it in Clarity Pro.

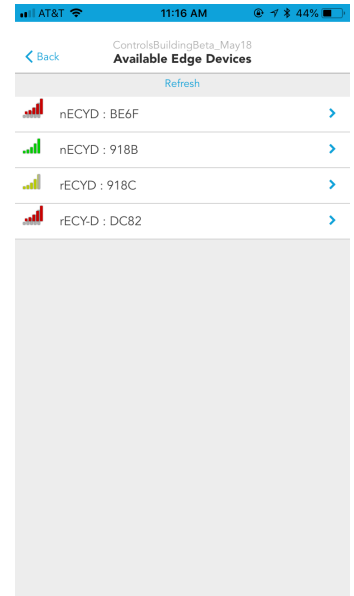

Figure 17: Available Edge Devices

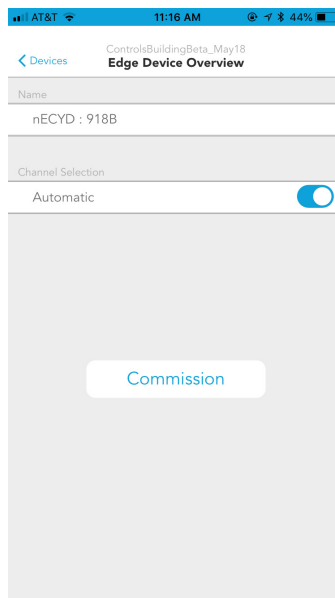

Figure 18: Edge Device Overview

Associate a Group with an nLight AIR Adapter



To associate an existing group with the nLight AIR Adapter, navigate to the Group Overview Screen. Walk to the physical space that correlates with the group. Tap on the “Edge Device Selector” option. Pick the appropriate Adapter from the list. Tap on the “Assign” button. Clarity Pro will make the appropriate RF Channel changes so the devices can communicate with the Adapter you’ve chosen.

Clarity Pro will also instruct the devices to attempt to communicate with the Adapter. The app will tell you once this process is complete. Once complete, the group will show as a networked group on the group screen with an icon next to the name. It will also be accessible in the Sensorview software.

Clarity Pro will show you any devices that are unable to communicate to the Adapter. You may retry. But, if the devices are unable to reach the adapter, please choose a different one on the project.

Move a Group from one nLight AIR Adapter to another

To move a group from one nLight AIR Adapter to another, navigate to the Group Overview Screen. Walk to the physical space that correlates with the group. Tap on “Networked Edge Device” and tap on the “Unassign” button. Once complete, the group will no longer be associated with that Adapter.

Now follow the steps to Associate a Group with the nLight AIR Adapter.

Making Customer Requests a Reality



In this section, we'll review how to take customer requests and create them in Clarity by creating zones and groups. To illustrate, we'll take an open office example that utilizes all the behaviors – on/off by switch, occupancy, and daylighting.

Consider Figure 19. In this space, there are 16 fixtures and two wall switches. The design calls for one switch to operate 8 of the fixtures and the other switch to operate the other 8 fixtures. The entire space should turn on and off with occupancy. And, the 4 fixtures along the window should dim with the presence of natural light.

We have started by identifying all the fixtures and adding them to the grid in a similar fashion to the physical layout (Figure 20).

Next, we have added the two switches to the grid (Figure 21). Note, the Clarity app will recognize the type of switch. So, we didn't need to indicate the number of buttons on the switches we've added.

Next, we'll start creating zones of control for all the devices that need to work together. So, first we'll select the switch and the top 8 fixtures by tapping on them in the grid (Figure 22).

- Legend:
- - Occupancy Controlled
 - - Daylighting Controlled
 - - Switch Controlled

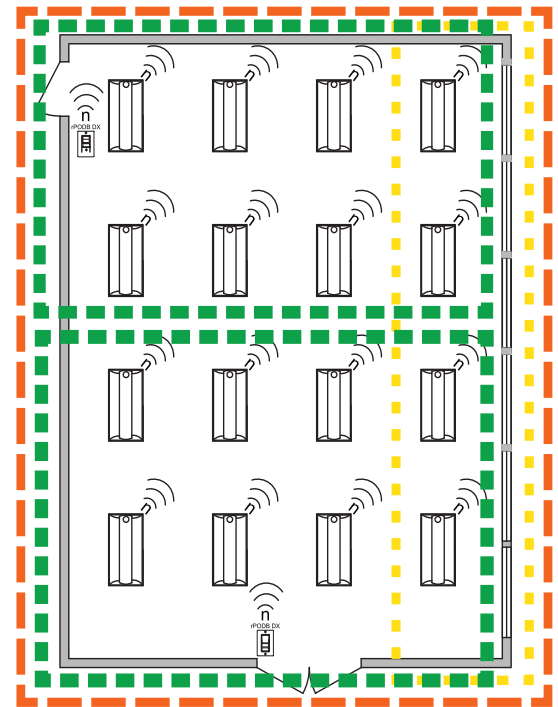

Figure 19: Layout Example

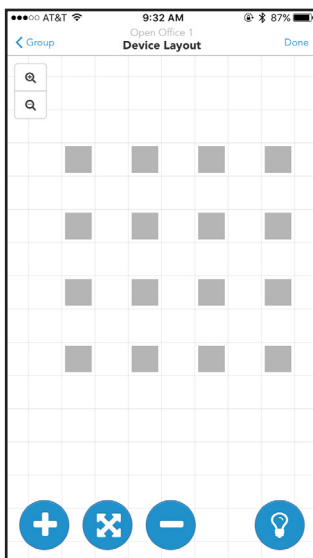

Figure 20: Layout On Grid

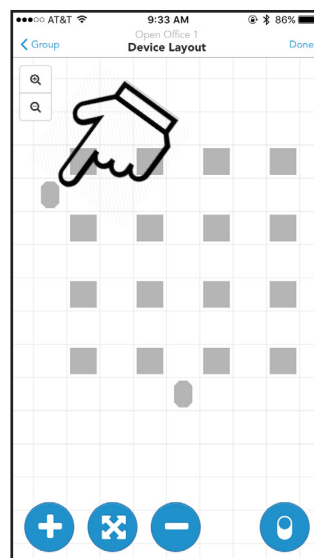

Figure 21: Layout with Switches

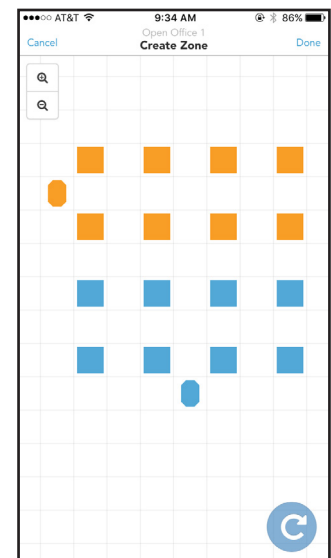

Figure 22: Creating Zones

We'll follow this process for each collection of devices that need to operate together. We've created the other switch zone (Figure 23), the occupancy zone (Figure 24), and daylighting zone (Figure 25). Note how in these images, the devices show as a lighter orange, indicating that the devices are already in one zone.

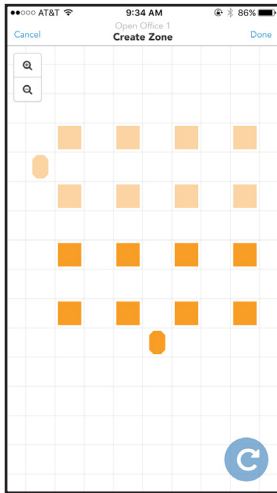

Figure 23: Switch Zone

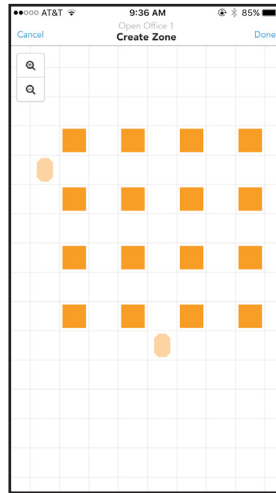

Figure 24: Occupancy Zone

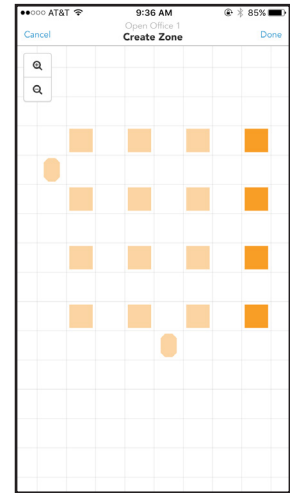

Figure 25: Daylighting Zone

We can assign each zone a behavior from the Group Overview screen. Select a zone to assign a behavior and then select one or more behavior for each zone (Figure 26). After we select on/off by switch for the first two zones, we apply an occupancy behavior for the zone with all the fixtures. We can choose the dim level and timeouts as discussed on [page 21 \(Behaviors Explained\)](#).

Finally, we assign a daylighting behavior to our zone of fixtures along the windows.

Once finished, tap save and the programming is pushed to the devices. After it is done, a screen like Figure 27 is displayed showing that the push of the settings was successful.

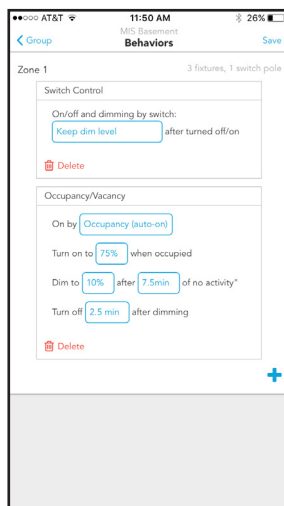

Figure 26: Zone Behavior

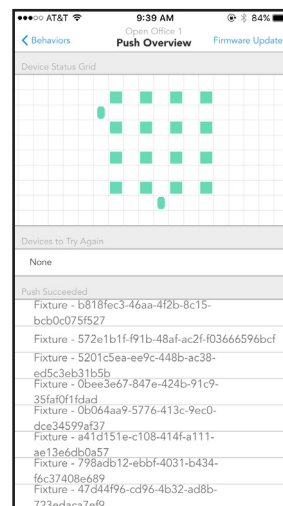

Figure 27: Push Overview

Adding Discovered nLight AIR Devices to a Zone



To add devices to an nLight AIR zone, follow the steps below.

1. Navigate to the Group Overview screen
2. Select the "Zones" from the Group Components section of the screen.
3. If this is the first zone in the group, your screen will appear like Figure 28.
4. Tap the "+" on the bottom of the screen.
5. The grid view will load. To add devices to the zone, tap them on the grid. As devices are added to the zone, they will turn orange (Figure 29). Those not in the zone will remain blue.
6. Once all devices that will operate together have been selected, tap next.
7. Once you return to the zones screen, your new zone and any others you create will appear in a list (Figure 30).

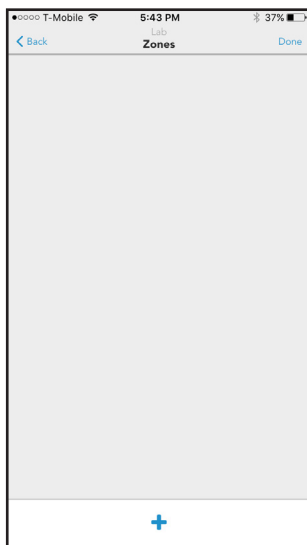

Figure 28: Zones

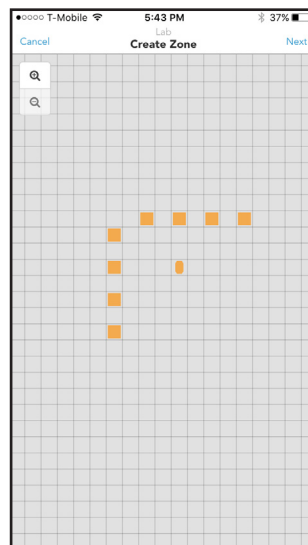

Figure 29 Create Zones

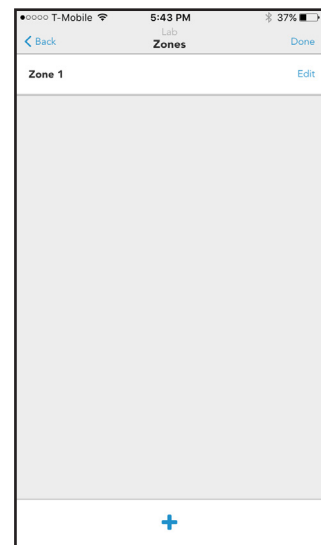

Figure 30: Zones List

NOTE

A zone will not do anything until a behavior has been assigned.

NOTE

Fixtures and power packs can be in multiple zones. Wall switches and sensors can only be in one zone.

Changing which nLight AIR Devices are in Modifying an Existing Zone



If you're modifying an existing zone, navigate to the group that contains the zone. From the list of existing zones, select the zone you want to modify by tapping on it in the list (Figure 31).

After you've selected it, you can add additional devices to the zone or remove devices from the zone, all by tapping on the grid.

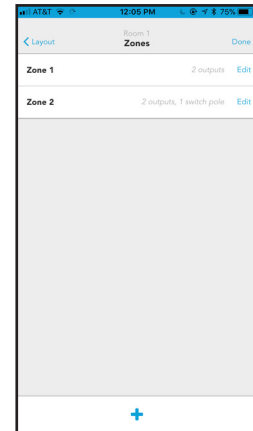

Figure 31: Modify Zones

Selecting a Behavior for a Zone

To select a behavior for a zone, follow the steps below:

1. Navigate to the Group Overview screen (Figure 32) for the group you're modifying.
2. Select Behaviors (Figure 33)
3. Choose a behavior for each zone.
4. Once the behavior has been selected, you may fine tune some of the parameters.

NOTE

The available parameters vary based upon the behavior selected.

5. Once complete, tap on the save icon. This will result in the programming being sent to the devices via Bluetooth (Figure 34)

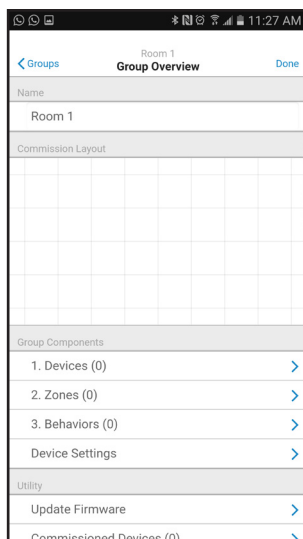

Figure 32: Group Overview

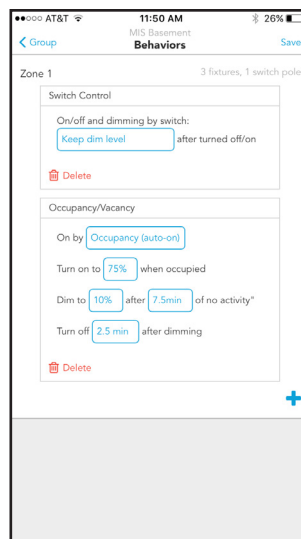

Figure 33: Behaviors

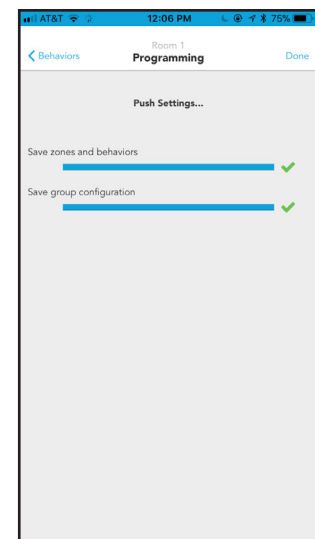

Figure 34: Programming

Below is a summary of all behaviors and how they can be configured. Please note that a zone may have one or more behaviors.

1. On / Off by switch

- Can be applied to any zone that has at least one fixture and one switch.
- You may select if the light comes on to full bright or if it turns on to the prior dim level when the on button is pressed.
- If combined with daylighting turning the lights on will make the fixtures go to their day lighting level. If the switch has raise and lower buttons, the user may raise the light level above the daylighting level.
- If combined with occupancy the switch will override the occupancy behavior for 1 minute

2. Occupancy

- Can be applied to any zone with at least 1 sensor.
- Configurable parameters include
 1. On by
 - Occupancy (Auto on) - lights will turn on when at least 1 sensor in the zone sees motion. Lights will dim down after "X" minutes of no activity.
 - Vacancy (On by Switch) - Lights must be turned on via a switch. Lights will dim down after "X" minutes of no activity.
 2. Turn on to xx% when occupied
 3. Dim to % - The level the lights will dim to after "X" minutes of no activity.
 4. After "X" minutes of no activity - The time delay between the sensors no longer sensing motion and the lights dimming to the dim to %.
 5. Turn off time - The time delay between the dim to light level and the lights turning off. Total time between no motion and the lights turning off is the sum of the turn off time and the dim after time.
- Immediately after sending programming values to the fixtures, the fixtures require a few minutes to synchronize before following the programmed time outs.

NOTE

After programming, devices must see motion. Then, all devices must NOT see motion for 3 minutes + the device's specified timeout period of no activity.

3. Daylighting

- Can be applied to any zone with at least 1 sensor.
- Must be calibrated after programming has been sent to the fixtures. This can be done by navigating to the group overview screen, selecting device settings, and selecting photosensor calibration.

NOTE

Users must select either 'individual' or 'common' photosensor. Individual photosensors can only be used if every fixture in the zone has a sensor. It will result in an inconsistent lighting look on the ceiling, but it may be more consistent on the work surface. Common photosensor will result in all the fixtures following one sensor which the user will select. This option will result in the common look at the ceiling.

Calibrating the Daylighting in an Area



To calibrate daylighting, follow the steps below:

1. Navigate to the Group.
2. From device settings choose photosensor calibration (Figure 35).
3. Manually adjust the set-point or choose to auto-calibrate the photosensor.

NOTE

You need to program a daylighting behavior for the daylighting zone

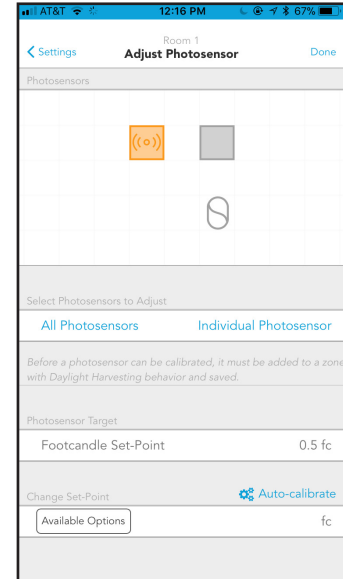

Figure 35: Photocell Calibration

Disable a Sensor

To optimize occupancy performance, sometimes it is necessary to disable sensors in fixtures. It may be necessary to do this to the fixture close to a doorway so it does not detect hallway traffic or in cases where sensors are very close to HVAC ducts.

To enable or disable particular sensors, navigate to the Group Overview Screen and choose the Devices Settings option (Figure 36). Tap on the "Occupancy Sensing" option (Figure 37). Select the sensor on the grid, disable the sensor, and tap save.

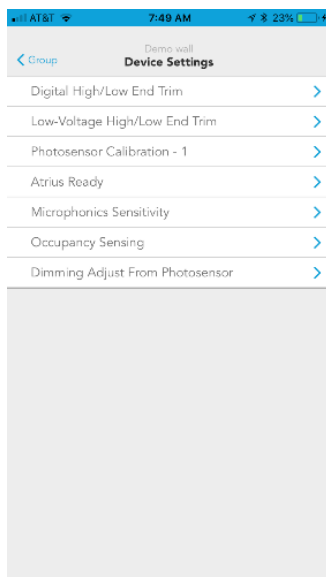

Figure 36: Device Settings

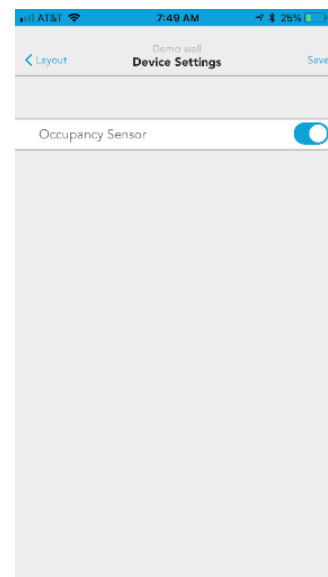

Figure 37: Occupancy Sensing

Setup Dual Zone Offset (Dimming Adjustment From Photosensor)



Dual Zone Offset is a feature that allows users to dim a second row of fixtures differently than the row closest to the windows in cases when only one sensor is being used. This feature is not needed in cases when each fixture has a sensor embedded.

To enable this feature, add all the fixtures that need to respond to daylight to one control zone. From the Group Overview Screen, choose the Devices Settings option. Tap on the “Dimming Adjustment from Photosensor” option (Figure 38).

Select the devices that should dim less than the other by tapping on the grid. Note, you may select more than one device at a time. Tap on the offset % value to make an adjustment and tap “Save”. Note, a value less than 100% will cause the fixtures selected to dim less than those not selected.

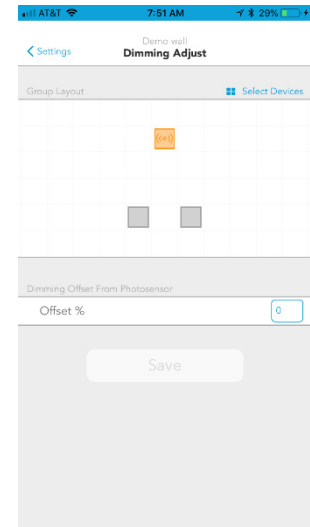

Figure 38: Dimming Adjust

Adjust Microphonics Sensitivity

To optimize occupancy performance, you have the ability to adjust the microphonics sensitivity (for devices that have this capability).

To adjust Microphonics Sensitivity values, navigate to the Group Overview Screen and choose the Devices Settings option (Figure 39). Tap on the “Microphonics Sensitivity” option (Figure 40). Select the sensor on the grid, adjust the setting from the drop down selector, and tap save.

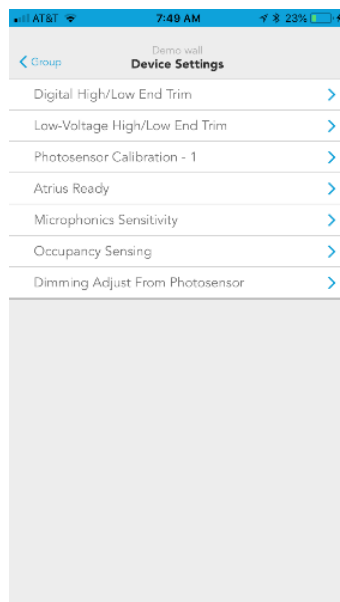

Figure 39: Device Settings

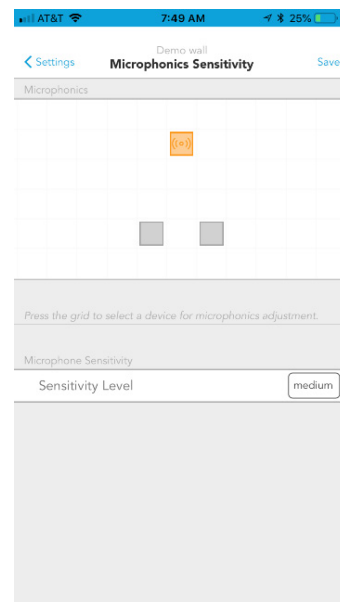

Figure 40: Microphonics Sensitivity

Set Hi/Low End Trim for Power Packs, rSBORs, and rSDGRs



To adjust the maximum or minimum light level an output device can achieve, you can adjust the Hi/Low End Trim.

To do so, navigate to the Group Overview Screen and choose the Devices Settings option (Figure 39). For 0-10V devices (such as the rPP20 Power Pack, rSDGR, and rSBOR), tap the “Low Voltage High/Low End Trim” option (Figure 41).

Tap on the devices you wish to change, use the sliders to make the adjustment, and tap save.

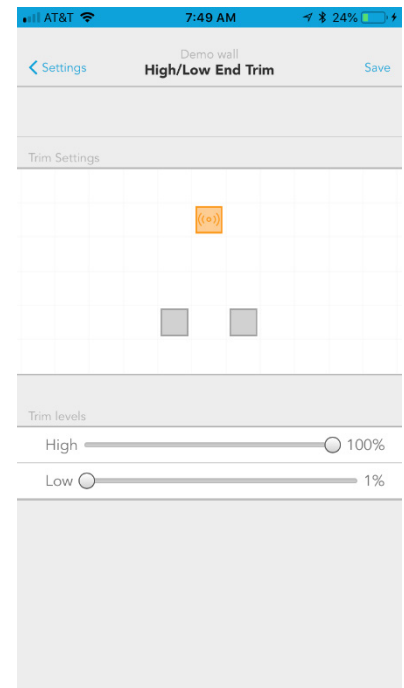

Figure 41: Hi/Low Trim Settings

Set Hi/Low End trim for rES7 and rIO-Based Fixtures

To adjust the maximum or minimum light level an output device can achieve, you can adjust the Hi/Low End Trim.

To do so, navigate to the Group Overview Screen and choose the Devices Settings option. For rES7 and rIO-Based fixtures, tap the “Digital High/Low End Trim” option.

Tap on the devices you wish to change, use the sliders to make the adjustment, and tap save.

Group Firmware Updates



Group Updates - The Clairity Pro mobile app is able to update the firmware in the nLight AIR devices. This should only be done when instructed by Acuity Tech Support or upon receiving a notification from the mobile app.

To do so, ensure you're physically located in range of the group to be updated. Navigate to the appropriate group in the Clairity Pro mobile app. Near the bottom of the group overview screen (Figure 42), tap "Update Firmware". The Firmware update screen (Figure 43) will show the latest version of firmware available and a summary of the firmware versions of the devices in the group. To update all devices, tap on the "Update All" button.

NOTE

This process may take 2 - 5 minutes. You may leave the area when the progress bar reaches 100%. Clairity Pro will tell you when you can move on to new areas.

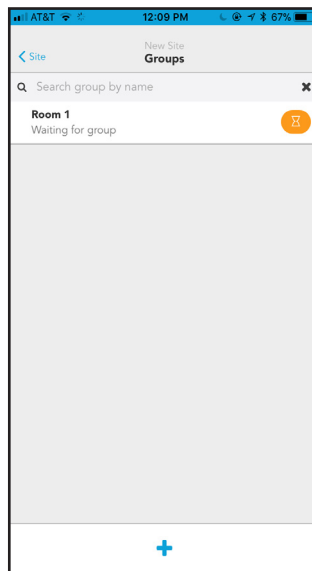

Figure 42: Group Overview

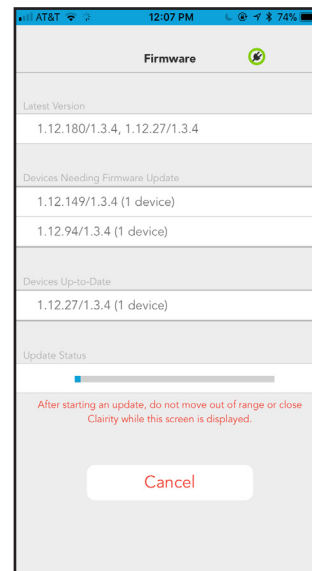

Figure 43: Group Firmware Update

Individual Device Firmware Updates



To update an individual device before it is commissioned, navigate to the site overview page (Figure 44) and tap on "Update Device Firmware."

From the list of devices, identify the device you want to update by using the Identify link (Figure 45). Tap update to start the firmware update process.

NOTE

You must remain within 60 feet of the device you're updating for the duration of the update, which may be 3-4 minutes.

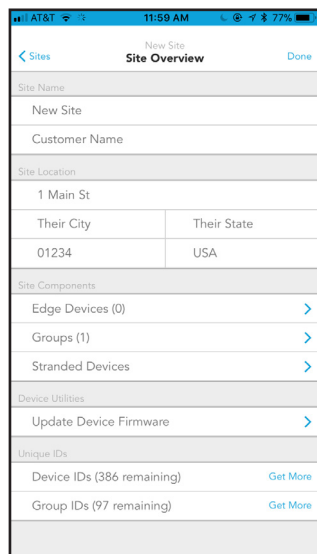

Figure 44: Site Overview

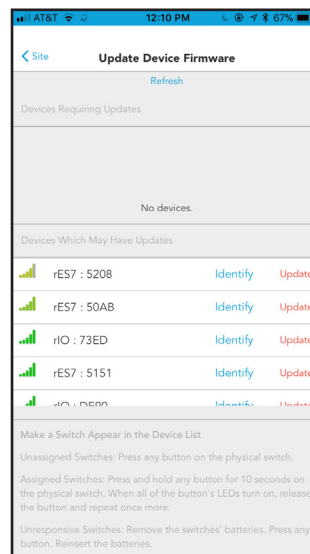

Figure 45: Update Firmware

For any site you create, you will have access to that site upon subsequent logins. However, you will not be able to see sites you did not create until access is granted to you. Please contact the original site creator to request access or reach out to Acuity. If you're not sure who created the site for the equipment you need to program, please reach out to Acuity Technical Support.

Sharing Sites

Sites may be shared with colleagues or customers. To do so, follow these steps:

1. In your browser, go to air.acuitynext.com (Figure 46)
2. When you log in, you'll see your sites.
3. Click on the particular site you wish to share.
4. Add the user with whom you'd like to share the site.
5. Once complete, that user will be able to access the site in Clarity Pro.

NOTE

You'll be unable to share a site with someone who has not gone through the process of creating a Clarity account.

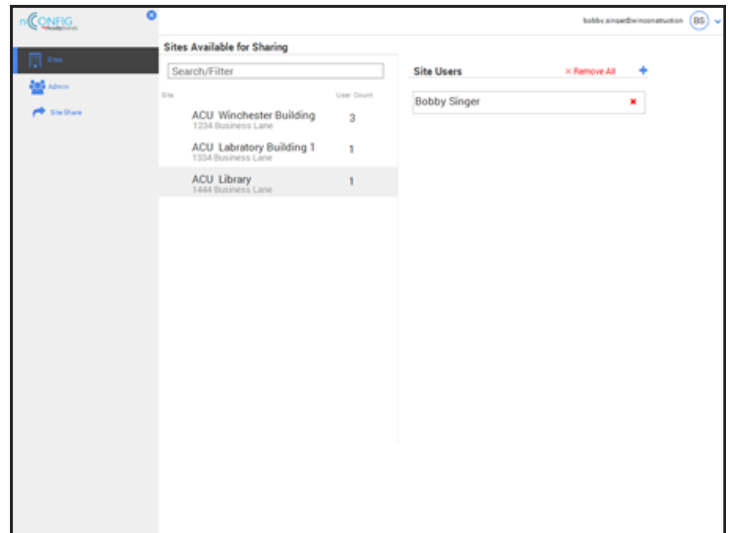

Figure 46: nLight AIR Website

Communication Architecture

The communication between the app and the devices behaves differently before and after the initial grouping process.

Prior to devices being added to a group:

- Before devices are added to a group, the app communicates directly to each device via Bluetooth.

After devices have been added to a group:

- After a devices have been added to a group, the app communicates with only one device (called the group monitor) within the group. That device then communicates to all the others on a different frequency.
- While the Bluetooth communication distance is approximately 100ft, it is possible the group monitor is out of range of the Bluetooth communication based on where you are standing within the area (especially for very large areas). If the Clarity app fails to connect to the Group Monitor, the application will display a grid representation of the group and indicate which device to move toward to facilitate communications.

If you're having trouble with a group, tap troubleshoot group at the bottom of the group overview screen (Figure 47). Clarity Pro will ask the group to perform a health check. Follow the steps the app asks you to complete. Each device will check in with the app and report the results (Figure 48). A successful test will verify inter-device communication and bluetooth connectivity to the mobile app. If a device is not found, ensure that it is physically installed and powered.



Figure 47: Troubleshooting

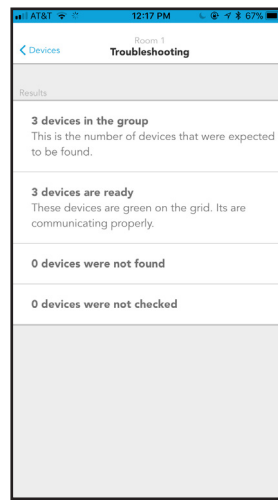

Figure 48: Troubleshooting Results

Who to Call if You Have Questions

For support with your nLight AIR controls system and the Clarity Pro mobile app, please contact Acuity Technical Support at 1-800-535-2465

Updating Clarity Pro



In the event that a new version of Clarity Pro is developed, you'll receive a notification through the app store that a new version has been made available. We recommend reading through the release notes associated with the new version so you can learn of the new features and capabilities of the new version prior to downloading it.

Multiple Users on One Site

More than one service provider may use the Clarity app at one time. This is most common in the case of large sites with relatively short construction cycles. Each user can run through the startup process (create groups, create zones, set behaviors). We have a few recommendations for how to maximize their efficiency.

- Any user who has access to the site can grant access to others.
- We suggest each resource work in a different portion of the building. The distance between resources minimizes the likelihood that devices will be flashed in someone else's area. Resources cannot perform startup activities within the same group.
- In the event that simultaneous users are in a building that has poor cellular coverage, we recommend regular communication with your colleagues to ensure each knows who is starting up which portion of the building, as changes they make on their mobile device will not show on your mobile device until those changes can be pushed to the cloud through a cellular or wireless connection.

Reprogramming an Area

If changes need to be made to a given area, navigate to the group that corresponds with that area. The same process is followed for button reprogramming, occupancy sensor adjustments, and photosensor recalibration.

- On the Group Overview screen, tap on "Behaviors"
- Adjust the behavior accordingly. The behavior screen allows for the adjustment of occupancy parameters and switch settings.
- Tap save and the programming will be pushed to the nLight AIR devices.

Whole Group Decommissioning



Whole group decommissioning is a process that will destroy all programming, zoning, and grouping. Essentially the fixtures will return to their out of box default state. Whole group decommissioning should **NOT** be used to modify zoning or programming parameters.

Whole group decommissioning should rarely be used. However, there are some circumstances where it makes sense. These include renovation of a previously commissioned nLight AIR space.

To decommission a group:

1. Navigate to the group overview screen.
2. Click on the commissioned devices link. The commissioned devices screen will load.
3. To proceed with decommissioning, tap the decommission all link.

NOTE

You must be located in the vicinity of the devices to perform this action.



Figure 49: Group Overview

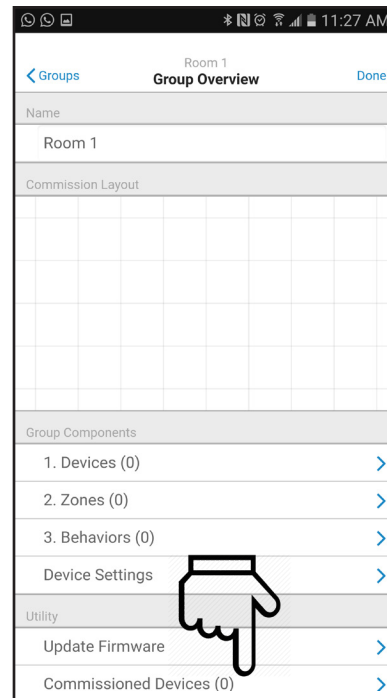

Figure 50: Commissioned Devices

Physically Removing Equipment

In the event that equipment needs to be physically removed from an area, you must first follow the "Removing Devices from the Grid" process described earlier in this document. Failing to do so will result in the inability to reprogram the device that has been removed.

Definition of Terms



Site	An installation of lighting control equipment for one customer at one location
Account	One or more sites that are all affiliated with one end user.
Area	A descriptor for a physical geographical area, within a customer site, that has some common use or purpose
Group	All the devices within one area
Identify	A process by which a device provides some visual feedback (e.g. - the flashing of a fixture) so it's location can be determined.
Zone	A collection of lighting fixtures expected to work together - resulting from a logical grouping
Behavior	The manner in which a collection of devices (zone) operate. Some people refer to this as the sequence of operation.
Fixture	A piece of equipment that outputs light
Switch	A piece of equipment that, is typically mounted on a wall, that a user may interact with to control lights in their vicinity
Device	A generic term used to describe the individual units that comprise a system.
Mobile Device	A personal handheld communication device that provides connectivity to wifi, cellular, or bluetooth
Startup	The act of troubleshooting and programming a new installation of equipment
Photosensor	A device that detects the presence of light.
Daylighting	A lighting control strategy that accounts for the presence of natural light and changes the artificial light to achieve a desired light level
Occupancy Sensor	A control device that detects motion

Audit Log



Initial Release	08-08-16
Updated to include features supported in version 1.2.1.62 of the Clarity mobile app	11-22-16
Updated to include features supported in version 1.3.0 of the Clarity mobile app	02-21-17
Updated to include features supported in version 1.4.0 of the Clarity mobile app	03/22/17
Updated to include features supported in version 1.4.0 of the Clarity mobile app	06/12/17
Updated to include features supported in version 1.5.2.5 of the Clarity Pro mobile app	03/14/18
Updated to include additional programming options	07/22/18