

# Quick Recommendation Guide

## Typical Applications

<b>Private Offices</b>		(Typical Energy Savings: 30% - 50%) <sup>†</sup>
Up to 15'x15'		
Without Obstructions	WSX ** / WSX D**	Sensor must have visibility to desktop activity
With Obstructions	WSX PDT VLP ** / WSX PDT D VLP **	Small rooms without direct line of sight (also required if occupant has back to sensor)
Up to 20'x20'	CM PDT 9*	Place within visual sight of main entry door
0-10V Dimming	WSX PDT D VLP ** or SPODMRD**	LED dimming control with or without motion sensor
<b>Conference Rooms</b>		(Typical Energy Savings: 30% - 50%) <sup>†</sup>
Up to 15'x15'	WSX PDT VLP** / WSX PDT D VLP**	Sensor will detect both motion and sound
Up to 20'x20'	CM PDT 9* or two CM PDT 9*	Place within visual sight of main entry door
Up to 30'x30'	WV PDT 16*	Place sensor in corner along entrance wall
<b>Classrooms</b>		(Typical Energy Savings: 40% - 60%) <sup>†</sup>
Up to 30'x30'	WV PDT 16*	Place sensor in corner along entrance wall
Greater than 30'x30'	Mult. WV PDT 16* or CM PDT 9*	Place sensors in opposite corners
<b>Open Office Areas</b>		(Typical Energy Savings: 20% - 40%) <sup>†</sup>
8'-10' Mounting Height	Multiple CM PDT 9*	Place sensors on 25' - 30' centers and cover all entrances
<b>Restrooms</b>		(Typical Energy Savings: 50% - 80%) <sup>†</sup>
Private	WSX ** / WSX D**	For rooms without obstructions
Private with Fan	WSX 2P**	No obstructions, relay 1 controls lights, relay 2 is for fan
Up to 4 Stalls	WSX PDT VLP ** / WSX PDT D VLP **	For rooms with obstructions
4 to 7 Stalls	CM PDT 9*	Place within visual sight of the main entry door
More than 7 Stalls	Multiple CM PDT 9*	Contact your Acuity Sales Representative for assistance
<b>Corridors</b>		(Typical Energy Savings: 20% - 60%) <sup>†</sup>
9' Mounting Height	CM 10*	Place sensors 50' on center
12' Mounting Height	CM 10*	Place sensors 60' on center
<b>Gymnasiums</b>		(Typical Energy Savings: 20% - 50%) <sup>†</sup>
25' Mounting Height	LSXR 6	Place sensors on 40' centers and cover all entrances
<b>Warehouses</b>		(Typical Energy Savings: 20% - 50%) <sup>†</sup>
360°, 15' - 45' Mounting Height	LSXR 6	1 sensor per fixture
Aisle Control	LSXR 50	Coverage spans multiple fixtures



**WSX**



**WSX D**



**SPODMRD**



**CM**



**WV**



**LSXR**

\* Requires power pack(s). <sup>†</sup>Results typical; actual savings may differ.

\*\*WSD series may be substituted in place of the WSX; see datasheet for product details.

# Wiring Diagrams

## LINE VOLTAGE SENSOR

(i.e., CMR 9)

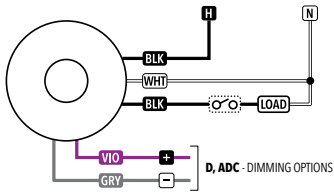

## LOW VOLTAGE

Single Sensor (i.e., CM 9)

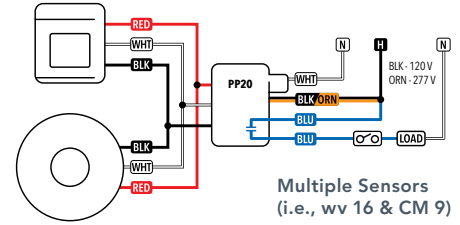
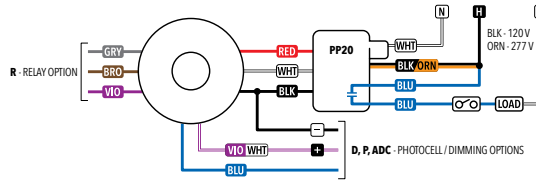

## WIRING TO GROUND (NO NEUTRAL)

Wall Switch Sensor Single Relay

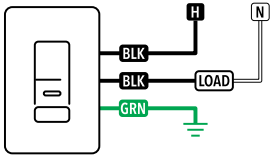

## WIRING TO NEUTRAL

Wall Switch Sensor Single Relay

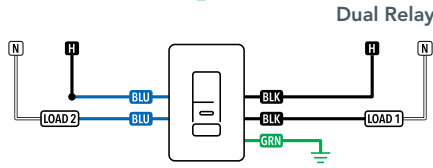
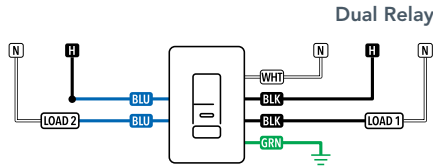
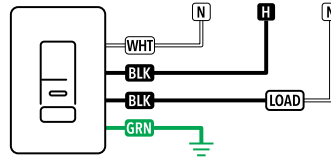

## Wire Color Key for Wiring to Ground or Wiring to Neutral

120/277 VAC Wiring

- Black\* Line 1 Input } Black Wires can be reversed
- Black\* Load 1 Output }
- Blue\* Line 2 Input } Blue Wires can be reversed
- Blue\* Load 2 Output }

### Notes:

- Unit will draw power from either line connection.
- When switching 277 VAC or 347 VAC on both relays, the line inputs must be of the same phase.

## BI-LEVEL (AUTO/MANUAL ON) SOLUTION WITH CEILING SENSOR: 2-GANG

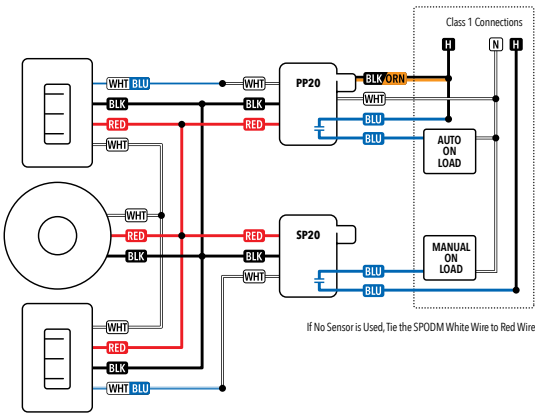

## CONVERSION FROM GROUND ONLY (NO NEUTRAL) TO NEUTRAL WIRING WITH WALL SENSOR

The product is pre-configured for wiring without a neutral; however, if connection to neutral is required by code, contractors can quickly and easily convert the unit in seconds.

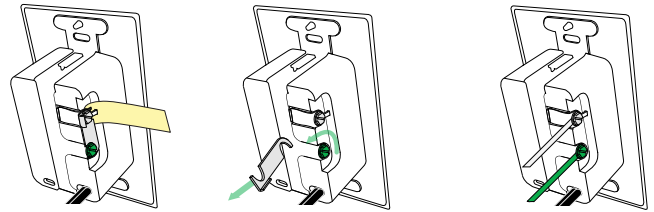

### STEP 1

Remove Yellow Label

### STEP 2

Loosen Screws & Remove Metal Link

### STEP 3

Connect Neutral to Silver Screw & Ground to Green Screw

## LINE VOLTAGE - SINGLE RELAY (I.E., LSXR XX)

Wiring to single Phase Power (120/277/347 VAC)

- Black<sup>1,2</sup> 120/277 VAC input (red wire for 347 VAC)
- Black<sup>1,2,3</sup> Switched line voltage output to luminaire (Red wire for 347 VAC)
- White Neutral
- Violet Low voltage dimming output (0-10 VDC) } Wires present with dimming options only
- Gray Low voltage common }

### Notes

- Black wires can be reversed.
- Wire is red for HVOLT version (required for 347 VAC)
- Disconnect and cap black output wire going to driver/ballast if switching fixture is not required.

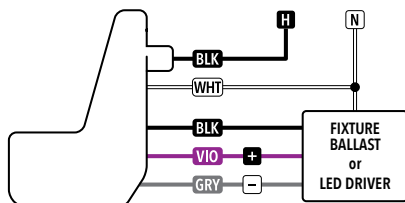

## LINE VOLTAGE - DUAL RELAY (I.E., LSXR XX 2P)

Wiring to single Phase Power (120/277/347 VAC)

- Black<sup>1,2</sup> Pole 1: 120/277 VAC input (red wire for 347 VAC)
- Black<sup>1,2,3</sup> Pole 1: Switched line voltage output to luminaire (Red wire for 347 VAC)
- White Neutral
- Blue<sup>2</sup> Pole 2: 120/277/347 VAC Input
- Blue<sup>2</sup> Pole 2: Switched line voltage output to luminaire

### Notes

- Black wires can be reversed.
- Blue wires can be reversed.
- Wire is red 347 VAC version.
- Red wires can be reversed.

