

Quick Recommendation Guide

Typical Applications

Private Offices		(Typical Energy Savings: 30% - 50%) [†]
Up to 15'x15'		
Without Obstructions	WSX ** / WSX D**	Sensor must have visibility to desktop activity
With Obstructions	WSX PDT VLP ** / WSX PDT D VLP **	Small rooms without direct line of sight (also required if occupant has back to sensor)
Up to 20'x20'	CM PDT 9*	Place within visual sight of main entry door
0-10V Dimming	WSX PDT D VLP ** or SPODMRD**	LED dimming control with or without motion sensor
Conference Rooms		(Typical Energy Savings: 30% - 50%) [†]
Up to 15'x15'	WSX PDT VLP** / WSX PDT D VLP**	Sensor will detect both motion and sound
Up to 20'x20'	CM PDT 9* or two CM PDT 9*	Place within visual sight of main entry door
Up to 30'x30'	WV PDT 16*	Place sensor in corner along entrance wall
Classrooms		(Typical Energy Savings: 40% - 60%) [†]
Up to 30'x30'	WV PDT 16*	Place sensor in corner along entrance wall
Greater than 30'x30'	Mult. WV PDT 16* or CM PDT 9*	Place sensors in opposite corners
Open Office Areas		(Typical Energy Savings: 20% -40%) [†]
8'-10' Mounting Height	Multiple CM PDT 9*	Place sensors on 25' - 30' centers and cover all entrances
Restrooms		(Typical Energy Savings: 50% - 80%) [†]
Private	WSX ** / WSX D**	For rooms without obstructions
Private with Fan	WSX 2P**	No obstructions, relay 1 controls lights, relay 2 is for fan
Up to 4 Stalls	WSX PDT VLP ** / WSX PDT D VLP **	For rooms with obstructions
4 to 7 Stalls	CM PDT 9*	Place within visual sight of the main entry door
More than 7 Stalls	Multiple CM PDT 9*	Contact your Acuity Sales Representative for assistance
Corridors		(Typical Energy Savings: 20% - 60%) [†]
9' Mounting Height	CM 10*	Place sensors 50' on center
12' Mounting Height	CM 10*	Place sensors 60' on center
Gymnasiums		(Typical Energy Savings: 20% - 50%) [†]
25' Mounting Height	LSXR 6	Place sensors on 40' centers and cover all entrances
Warehouses		(Typical Energy Savings: 20% - 50%) [†]
360°, 15' - 45' Mounting Height	LSXR 6	1 sensor per fixture
Aisle Control	LSXR 50	Coverage spans multiple fixtures



Wall Switch Sensor
WSX



Wall Switch with Dimming
WSX D



Switch Interface
SPODMRD



Ceiling Mount Sensor
CM



Wide View Sensor
WV



Fixture Mount Sensor
LSXR

* Requires power pack(s). [†]Results typical; actual savings may differ.

**WSD series may be substituted in place of the WSX; see datasheet for product details.

Wiring Diagrams

LINE VOLTAGE SENSOR

(i.e., CMR 9)

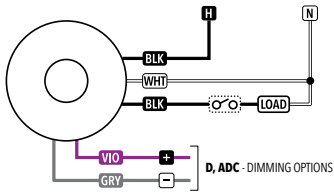

LOW VOLTAGE

Single Sensor (i.e., CM 9)

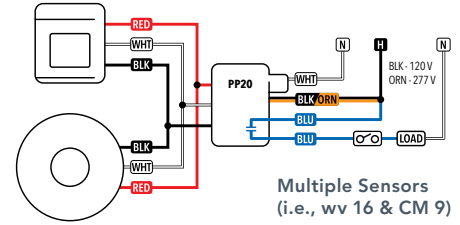
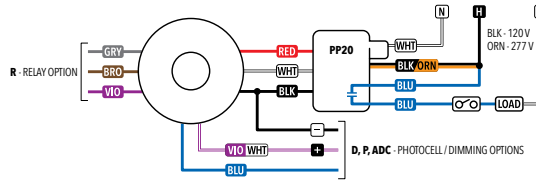

WIRING TO GROUND (NO NEUTRAL)

Wall Switch Sensor Single Relay

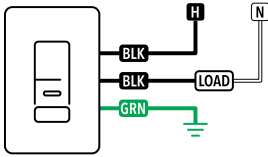

WIRING TO NEUTRAL

Wall Switch Sensor Single Relay

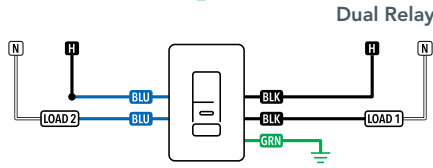
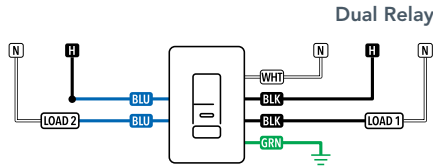
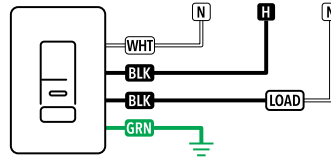

Wire Color Key for Wiring to Ground or Wiring to Neutral

120/277 VAC Wiring

- Black* Line 1 Input } Black Wires can be reversed
- Black* Load 1 Output }
- Blue* Line 2 Input } Blue Wires can be reversed
- Blue* Load 2 Output }

Notes:

- Unit will draw power from either line connection.
- When switching 277 VAC or 347 VAC on both relays, the line inputs must be of the same phase.

BI-LEVEL (AUTO/MANUAL ON) SOLUTION WITH CEILING SENSOR: 2-GANG

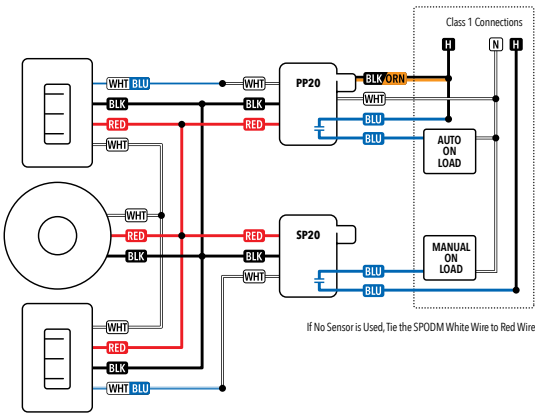

CONVERSION FROM GROUND ONLY (NO NEUTRAL) TO NEUTRAL WIRING WITH WALL SENSOR

The product is pre-configured for wiring without a neutral; however, if connection to neutral is required by code, contractors can quickly and easily convert the unit in seconds.

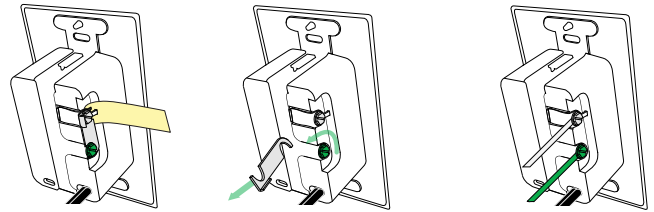

STEP 1

Remove Yellow Label

STEP 2

Loosen Screws & Remove Metal Link

STEP 3

Connect Neutral to Silver Screw & Ground to Green Screw

LINE VOLTAGE - SINGLE RELAY (I.E., LSXR XX)

Wiring to single Phase Power (120/277/347 VAC)

- Black^{1,2} 120/277 VAC input (red wire for 347 VAC)
- Black^{1,2,3} Switched line voltage output to luminaire (Red wire for 347 VAC)
- White Neutral
- Violet Low voltage dimming output (0-10 VDC) } Wires present with dimming options only
- Gray Low voltage common }

Notes

- Black wires can be reversed.
- Wire is red for HVOLT version (required for 347 VAC)
- Disconnect and cap black output wire going to driver/ballast if switching fixture is not required.

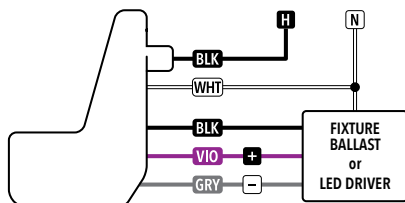

LINE VOLTAGE - DUAL RELAY (I.E., LSXR XX 2P)

Wiring to single Phase Power (120/277/347 VAC)

- Black^{1,2} Pole 1: 120/277 VAC input (red wire for 347 VAC)
- Black^{1,2,3} Pole 1: Switched line voltage output to luminaire (Red wire for 347 VAC)
- White Neutral
- Blue² Pole 2: 120/277/347 VAC Input
- Blue² Pole 2: Switched line voltage output to luminaire

Notes

- Black wires can be reversed.
- Blue wires can be reversed.
- Wire is red 347 VAC version.
- Red wires can be reversed.

