

- To reduce the risk of death, personal injury or property damage from fire, electric shock, falling parts, cuts/abrasions, and other hazards please read all warnings and instructions included with and on the fixture box and all fixture labels.
- Before installing, servicing, or performing routine maintenance upon this equipment, follow these general precautions.
- Installation and service should be performed by a qualified licensed electrician.
- Maintenance should be performed by qualified person(s) familiar with the products' construction and operation and any hazards involved. Regular maintenance programs are recommended.
- DO NOT INSTALL DAMAGED PRODUCT! This product has been properly packed so that no parts should have been damaged during transit. Inspect to confirm. Any part damaged or broken during or after assembly should be replaced.
- These instructions do not purport to cover all details or variations in equipment nor to provide every possible contingency to meet in connection with installation, operation, or maintenance. Should further information be desired or should particular problems arise which are not covered sufficiently for the purchaser's or owner's purposes, this matter should be referred to Acuity Brands Lighting, Inc.



#### WARNING RISK OF ELECTRIC SHOCK

- Disconnect or turn off power before installation or servicing.
- Verify that supply voltage is correct by comparing it with the product information.
- Make all electrical and grounded connections in accordance with the National Electrical Code (NEC) and any applicable local code requirements.
- All wiring connections should be capped with UL approved recognized wire connectors.
- All unused connector openings must be capped



#### WARNING RISK OF BURN OR FIRE

- Do not exceed maximum wattage, ratings, or published operating conditions of product.
- Do not overload.
- Follow all manufacturer's warnings, recommendations and restrictions to ensure proper operation of product.



#### WARNING RISK OF INJURY

- Wear gloves and safety glasses at all times when installing, servicing or performing maintenance.



#### CAUTION: RISK OF PRODUCT DAMAGE

- Electrostatic Discharge (ESD): ESD can damage product(s). Personal grounding equipment must be worn during all installation or servicing of the unit.
- Do not touch individual electrical components as this can cause ESD and affect product performance.
- Do not stretch or use cable sets that are too short or are of insufficient length.
- Do not tamper with contacts.
- Do not modify the product.
- Do not change or alter internal wiring or installation circuitry.
- Do not use product for anything other than its intended use.
- If installing wiring systems: Materials and component parts of a manufacturing wiring system as described in Article 604 of the National Electric Code and Underwriters Laboratories Standard for Safety #183 MUST BE installed

Failure to follow any of these instructions could void product warranties. For a complete listing of product Terms and Conditions, please visit [www.acuitybrands.com](http://www.acuitybrands.com).

## Fresco™ Touchscreen Quick-Start Guide

### Overview

Fresco is a touchscreen lighting controller. Powered by 24 VDC, Fresco controls nLight® devices, DMX/RDM devices and networks with other Fresco components including touchscreens, wallstations and lighting management panels.

Follow these simple steps to install and power the Fresco touchscreen.

We are available to help via phone or on site. Contact us now: 800-535-2465

### Mounting (Box Prep)

1. Install a grounded 3-gang backbox.
2. Align mounting ring (provided) with 3-gang backbox (not provided).
3. Level mounting ring.
4. Tighten the 2 captive screws on center mounting holes.
5. Optional: Use additional mounting screws if ring holes align with backbox holes (Note: if backbox is level holes will align. Only 2 screws are required for proper fastening).
6. Optional: If mounting ring is not flush to the surface of the wall, use 2 drywall screws (not provided) to secure the mounting ring to the finished wall and use mounting screws to pull the backbox forward.

Fresco Mounting Ring

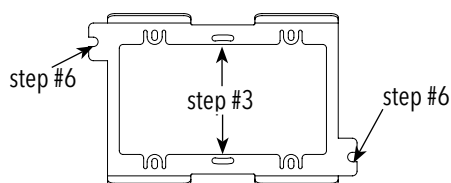

### Securing the Station

1. Hang Fresco from the top flanges of the mounting ring once all wiring is completed.
2. Lift slightly and push Fresco flush to wall.
3. Tighten 2 set screws on the bottom of the Fresco using 1/16" hex wrench (provided).

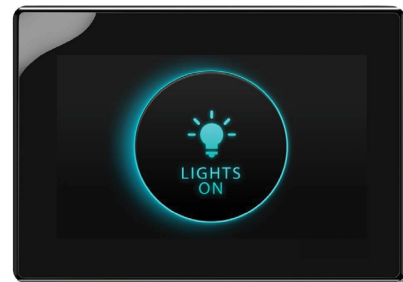

Section of a Properly Installed Fresco Touchscreen

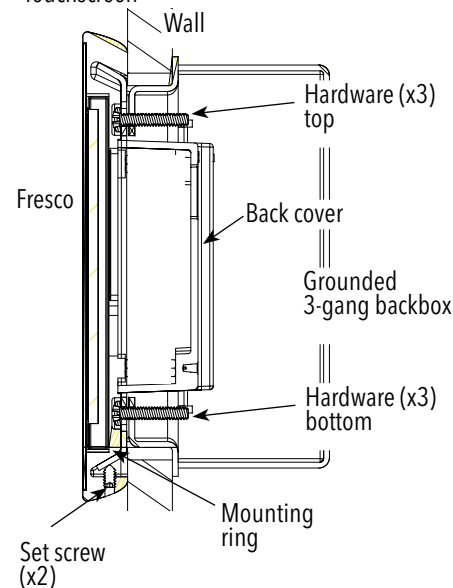

## Power Supply

1. Install power supply in grounded metal box.
  2. Route Class 2 conductors to Fresco backbox.
  3. Connect Class 2 power to Fresco's 4-wire connector.
- Red: +24 VDC  
Black: Common

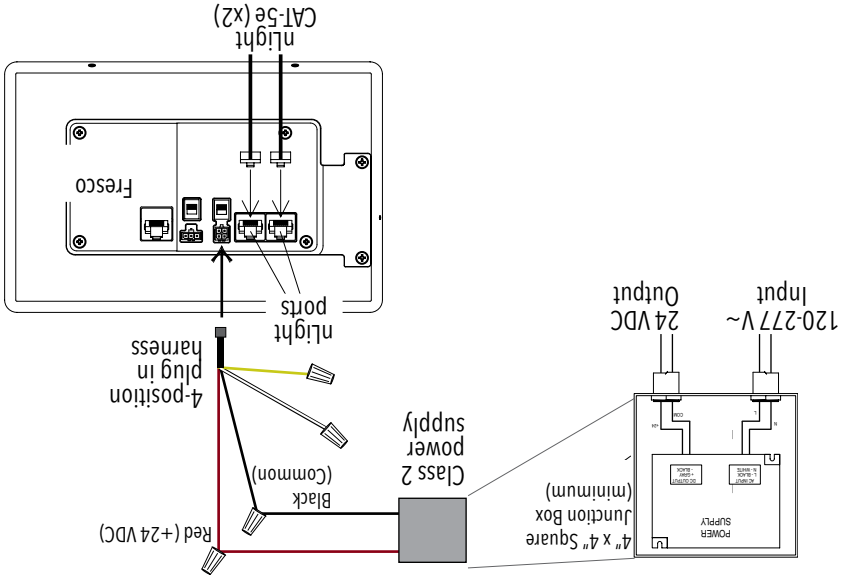

## Connecting nLight® Devices

- 2 nLight ports support daisy chaining. Fresco may be located in any position on the nLight link for proper operation.
- Fresco provides 40mA per output to power connected nLight devices.
- Follow nLight design rules to determine if additional power supplies are required.

Note: Fresco supports a maximum of 128 nLight devices.

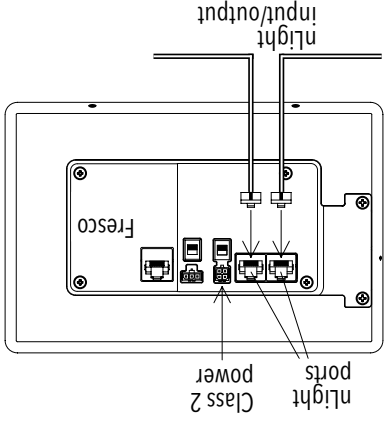

## Connecting DMX/RDM Devices

- Use provided 3-position harness.
- Color & signals: Black: Common
- White with black stripe: DMX Data+
- Yellow with black stripe: DMX Data-

- Connect DMX shield to ground at one point in the DMX network; preferably on the grounded backbox of the Fresco touchscreen.
- DMX network connects Fresco stations to lighting management panels (LMP/

### NOTES

- Follow DMX/RDM wiring standards, use RS-485 compatible cable or Category cable (CAT-5/-5e/-6).
- DMX/RDM must be terminated at the start & end and daisy chained.

DMX/RDM pin out with XLR

XLR Pin #	Purpose	Common	Data -	Data +	No connection	4, 5
1	Common					
2	Data -					
3	Data +					
4, 5	No connection					

DMX/RDM pin out with CAT-5/-5e/-6

Pin #	Wire Color	Purpose	Data +	Data -	No connection	7
1	white/orange	Data +				
2	orange	Data -				
3, 4, 5, 6, 8	various	No connection				
7	white/brown	Common				

## Connecting Additional Frescos

- Use provided 4-position harness.
- Color & signals: Red: +24 VDC
- Black: Common
- White: FCN Data+
- Yellow: FCN Data-

### NOTES

- FCN must be daisy chained.
- FCN must be terminated at the start & end of the daisy chain.



Other positions End of daisy chain (not terminated)  
End of daisy chain (terminated)

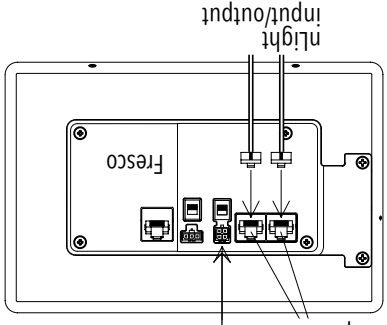

to additional Fresco stations

Other positions End of daisy chain (not terminated)  
End of daisy chain (terminated)

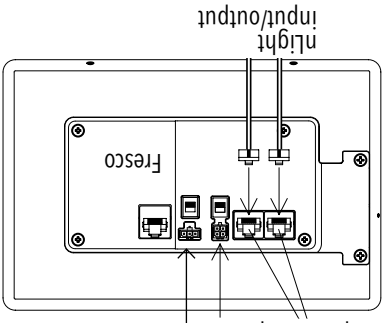

to DMX/RDM Luminaires and Fresco Lighting Management Panels