



Blue Box LTD Operation, Programming and Maintenance Manual

Project Name:
Project Location:
Acuity Agency:
Order #:
PO #:
Project ID:
Date:

Controls Tech Support:

1-800-535-2465 - option 1: nLight; option 2: SSI; option 3: Fresco; option 4: Synergy; option 5: LC&D/Bluebox; option 6 ROAM
To preschedule a call with tech support (providing a 4 hour business lead time) go to the following link: <http://www.acuitybrands.com/resources/schedule-support-request>

Additional Technical Literature:

<https://www.acuitybrands.com/products/controls/blue-box>

Table of Contents

| | |
|--|----|
| <u>Blue Box LTD Programming Guide</u> | 3 |
| <u>Blue Box LTD Occupancy Sensor Hookup</u> | 15 |
| <u>Blue Box LTD Troubleshooting with an Oscilloscope</u> | 17 |
| <u>Blue Box LTD Photocell Hookup Guide</u> | 20 |
| <u>Blue Box LTD Parts Replacement Guide</u> | 24 |
| <u>Chelsea Digital Switch Programming Guide</u> | 30 |
| <u>Additional Resources (Product specific user guides, Programming documents, etc)</u> | 50 |

BLUE BOX™ LTD

PROGRAMMING GUIDE

WARNINGS

1. All servicing should be performed by qualified service personnel.
2. "WARNING, Battery may explode if mistreated. Do not recharge, disassemble or dispose of in fire."
3. "CAUTION - This equipment provides more than one power supply output source. To reduce the risk of electric shock disconnect both normal and emergency sources within this unit before servicing any equipment connected to this unit"
4. When using electrical equipment, basic safety precautions should always be followed including the following:
 - READ AND FOLLOW ALL SAFETY INSTRUCTIONS.
 - Do not use outdoors.
 - Do not mount near gas or electric heaters.
 - Equipment should be mounted in locations and at heights where it will not readily be subjected to tampering by unauthorized personnel.
 - The use of accessory equipment not recommended by the manufacturer may cause an unsafe condition.
 - Do not use this equipment for other than intended use.
 - SAVE THESE INSTRUCTIONS.
5. If any Emergency Circuits are fed or controlled from this panel, it must be located electrically where fed from a UPS, generator, or other guaranteed source of power during emergency and power outage situations.

BLUE BOX LTD GENERAL PROGRAMMING

DIGITAL TIME CLOCK (DTC) NAVIGATION BASICS

1. SCROLL through choices in one field
2. TAB to position the cursor
3. DELETE information or programming about an item. Use caution.
4. ENTER to select
5. EXIT to leave a screen

Note: Each set of 4 relays in the Dimming BBLTD panel take 2 addresses and 1 LCP number, thus the 16 relay panel takes 8 addresses and 4 LCP numbers.

ADDRESSING THE BLUE BOX LTD DIMMING CONTROL CARD

If the Blue Box LTD has been pre-programmed and pre-addressed at the factory, please be sure to check that the assigned address is not conflicting with any other devices on the bus.

Starting at the main screen, press ENTER to get to the USER MENU

2. TAB to SETUP MENU, press ENTER
3. Press ENTER to select "RESTRICTED"
4. SCROLL/TAB to enter password {900001} and press ENTER
5. Select ADDRESSING BUS SCAN and press ENTER
6. TAB to ADDRESS BY BUTTON, press ENTER
7. SCROLL to the desired start address
8. Press the physical address button 1 on the control card. The start address on the DTC screen will be assigned to the card, and the clock will show the next available address after the address pair. Repeat for the remainder of the LCPs.

9. Once addressing is complete, press Exit and TAB to BUS MAP to assign the desired LCP numbers.

NOTE: There are multiple address buttons on a single control card and each address button on the control card will need to be sequentially pressed to completely address the board before moving on to the next step.

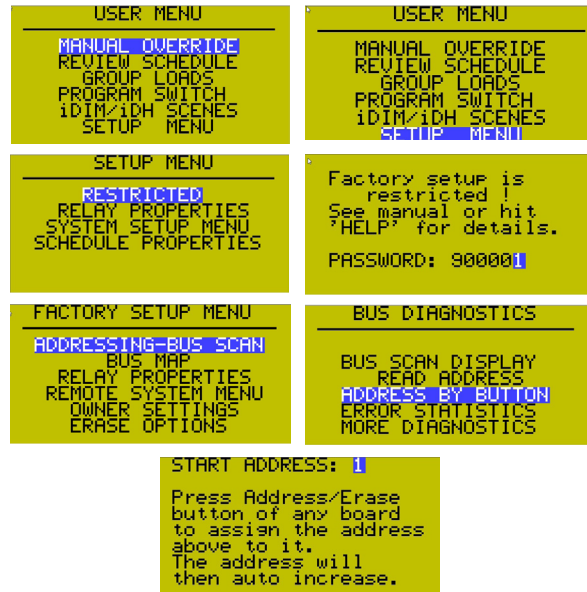

ADDRESSING

Starting at the main screen, press ENTER to get to the USER MENU

1. TAB to SETUP MENU and press ENTER
2. TAB to SYSTEM SETUP MENU and press ENTER
3. TAB to ADDRESSING-BUS SCAN and press ENTER
4. TAB to ADDRESS BY BUTTON and press ENTER
5. By default, the START ADDRESS is set to 1
6. SCROLL to select the address to be assigned to the device, followed by pressing the address button on the control card or device. The address number on the display screen will increment to the next sequential address.
7. EXIT to BUS DIAGNOSTICS menu
8. TAB to READ ADDRESS and press ENTER
9. Press the address button on the control card or the device and the screen will display the address assigned to that device.
10. EXIT to BUS DIAGNOSTICS when complete.
11. TAB to BUS SCAN DISPLAY and press ENTER to view the device addresses on the network bus.
12. EXIT to main menu when complete.

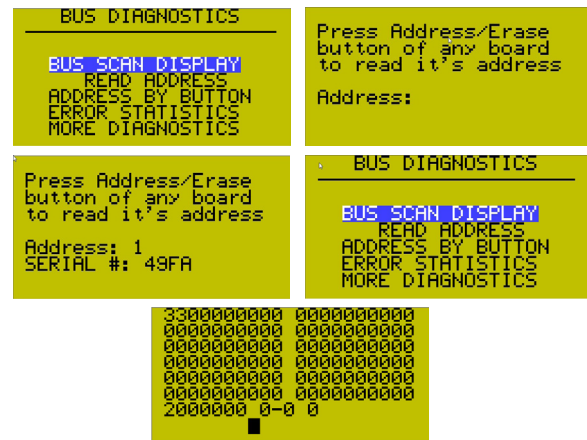

BUS SCAN DISPLAY

The Bus Scan Display is a diagnostic tool used for locating devices, their address on the bus and any errors. Typically caused by collisions due to multiple devices with the same address.

NOTE: For more diagnostic help, see Scan By Serial in the Diagnostic section of this manual.

Each device will be represented by 1, 2, 3 or a 0

- 1-Digital Switches, accessories.
- 2-Link 2 Cards
- 3-Control Panels
- 0-Empty space on the bus

Located at the bottom of the bus scan display are the number of drop offs, the number of signals sent out to a single device and errors. Shown in the image provided.

- Drop offs- Once a device is sent a signal with multiple try's, it is then dropped and the scan moves to the next device on the bus. This number is reset every scan.
- Number of Signals Sent- This is the number of signals sent out to a single device on the bus before it is dropped.
- Errors- This is the total number of errors during the scan.

For details for a single device on the bus, see Error Statistics

NOTE: Clear the **ERROR STATS** before doing a bus scan.

Error Statistics:

1. Starting at the BUS DIAGNOSTIC MENU
2. TAB down to ERROR STATISTICS. ENTER

```

BUS DIAGNOSTICS
-----
BUS SCAN DISPLAY
  READ ADDRESS
  ADDRESS BY BUTTON
  ERROR STATISTICS
  MORE DIAGNOSTICS
  
```

```

ERROR STATS. CLEAR
Overall: 0
Addr1: 0
Cmd0: 0
EEPROM FLAG ERR: 0
EEPROM WRITE ERR: 0
DROP-OFF: 0
FATAL-ERR: 0
  
```

Searching error stats by address:

3. TAB down to Addr1:
4. SCROLL to choose from different addresses on the bus. This will give you a more specific look at a problem device.

```

ERROR STATS. CLEAR
Overall: 0
Addr1: 0
Cmd0: 0
EEPROM FLAG ERR: 0
EEPROM WRITE ERR: 0
DROP-OFF: 0
FATAL-ERR: 0
  
```

```

ERROR STATS. CLEAR
Overall: 0
Addr1: 0
Cmd0: 0
EEPROM FLAG ERR: 0
EEPROM WRITE ERR: 0
DROP-OFF: 0
FATAL-ERR: 0
  
```

Searching error stats by serial:

5. TAB down to Cmd0:
 6. SCROLL to choose from different serial numbers.
- If you are seeing multiple collisions, there could be multiple devices with the same address. In this case, you will want to search by serial number.

NOTE: Also use **SCAN BY SERIAL** to locate any addressing collisions.

```

ERROR STATS. CLEAR
Overall: 0
Addr1: 0
Cmd0: 0
EEPROM FLAG ERR: 0
EEPROM WRITE ERR: 0
DROP-OFF: 0
FATAL-ERR: 0
  
```

```

ERROR STATS. CLEAR
Overall: 0
Addr1: 0
Cmd0: 0
EEPROM FLAG ERR: 0
EEPROM WRITE ERR: 0
DROP-OFF: 0
FATAL-ERR: 0
  
```

Scan By Serial:

1. Starting at BUS DIAGNOSTICS
 2. TAB down to MORE DIAGNOSTICS. ENTER
 3. t the MORE DIAGNOSTICS menu, TAB down to DEVICE MANAGEMENT. ENTER
 4. SCAN BY SERIAL. ENTER
- Once you hit enter, the system will scan the bus and give you the number of items found, Collisions and how many devices NOT addressed.
5. Hit ENTER for details.
 6. SCROLL down to view the serial number(s) on the bus.
 7. TAB down to Address
 8. SCROLL to change the addresses associated with each serial number.
 9. TAB down to SAVE ADDRESS CHANGES. ENTER
 10. This will ask you to save changes. TAB to "YES or "NO". ENTER

```

BUS DIAGNOSTICS
-----
BUS SCAN DISPLAY
  READ ADDRESS
  ADDRESS BY BUTTON
  ERROR STATISTICS
  MORE DIAGNOSTICS
  
```

```

MORE DIAGNOSTICS
-----
DEFAULT TO MAIN: Yes
HIDDEN MENUS: OFF
DROPOFF STATS 1-80
DROPOFF STATS 81-127
  RESET COUNTS
  DEVICE MANAGEMENT
  
```

```

DEVICE MANAGEMENT
-----
SCAN BY SERIAL#
ERASE ALL ADDRESSING
  AUTO ADDRESSING
  SCAN FOR ZERO ID ON
  POWER UP: YES
  SYNC BYTE: NO
  
```

```

SCAN BY SERIAL#
-----
Scanning complete.
Found 1 items.
Collisions: 0
Not addressed: 0
Hit ENTER when ready.
  
```

```

SCAN BY SERIAL#
Serial #: 49fa
Address: 1
Item type: Dim/DH
Mapped:Panel LCP1
Address OK
SAVE ADDRESS CHANGES
  
```

```

SCAN BY SERIAL#
Serial #: 49fa
Address: 1
Item type: Dim/DH
Mapped:Panel LCP1
Address OK
SAVE ADDRESS CHANGES
  
```

```

SCAN BY SERIAL#
Serial #: 49fa
Address: 1
Item type: Dim/DH
Mapped:Panel LCP1
Address OK
SAVE ADDRESS CHANGES
  
```

```

SCAN BY SERIAL#
Save all changes ?
NO/YES
Press EXIT to quit.
After saving system
will rescan.
  
```

BUS MAPPING

Repeat steps 1-4 from ADDRESSING THE BLUE BOX LTD DIMMING CONTROL CARD

1. At FACTORY SETUP MENU, TAB to BUS MAP and press ENTER
2. PAGE 1-19 is highlighted. Scroll on this field to access higher / lower displayed pages
3. TAB to first address on the BUS MAP
4. Scroll to select the device type, LCP number, or number of buttons assigned to a switch
 - Panel LCP 1-64
 - 4RLYPNL LCP 1-64: Virtual LCPs: Typically assigned to physical and virtual relay panels

NOTE: Relay panel control cards requiring multiple sequential addresses will automatically select and assign the selected LCP number to all addresses used by the device when the tab down button is pressed.

 - ANALOG/DIGITAL: Typically used for legacy standard 4 relay micro panels
 - PHOTOCCELL 1: PCC 1 card:
 - PHOTOCCELL 3: PCC 3 card

Exit the BUS MAP menu once all control cards and other devices on the network have been mapped

```

USER MENU
-----
MANUAL OVERRIDE
REVIEW SCHEDULE
  GROUP LOADS
  PROGRAM SWITCH
  IDIM/IDH SCENES
  SETUP MENU
  
```

```

SETUP MENU
-----
RESTRICTED
REVIEW SCHEDULE
  GROUP LOADS
  PROGLE PROPERTIES
  
```

```

Factory setup is
restricted !
See manual or hit
HELP for details.
PASSWORD: 900001
  
```

```

FACTORY SETUP MENU
-----
ADDRESSING-BUS SCAN
  BUS MAP
  RELAY PROPERTIES
  REMOTE SYSTEM MENU
  OWNER SETTINGS
  ERASE OPTIONS
  
```

```

BUS MAP PAGE 1-19
ID1 : Panel LCP1
ID2 : Panel LCP1
ID3 : Panel LCP2
ID4 : Panel LCP2
ID5 : 6 Btn. Switch
ID6 : Photocell 1
ID7 : Unused
  
```

RELAY PROPERTIES

Starting at USER MENU

1. TAB to SETUP MENU. ENTER
2. RESTRICTED. ENTER
3. Password {900001}. ENTER
4. At FACTORY SETUP MENU, TAB to RELAY PROPERTIES. ENTER



Setting Relay Delay:

This function sets a fixed delay between relays toggling when grouped and activated by a switch button push or sensor control.

Once in the RLY Params, the relay delay will be highlighted. (DLY:1)

6. SCROLL to edit the relay delay

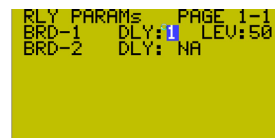

Setting the Blink Level

This function sets the blink warning dimming level

7. TAB over to the blink warning level. (LEV:50)

8. SCROLL to edit.

NOTE: Default is set to 50

9. ENTER when done.

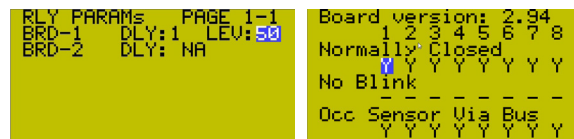

Setting Relays to Normally Open/Normally Closed:

Under NORMALLY CLOSED you will see "YYYYYYYY" These Represent the eight relays to a panel. The first relay will be highlighted when you enter this menu.

10. TAB to choose a relay

11. SCROLL to edit the relay

- Y: Normally closed relay
- -: Normally open relay

12. Press ENTER when done.

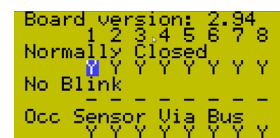

Setting a Blink Warning with Horn Driver

This feature is for providing an audible blink warning when the output is wired to external horn device.

13. TIMER IS DISABLED will be highlighted

14. SCROLL to ENABLE TIME and press ENTER

15. SCROLL to enable or disable HORN DRIVER MODE (NO by factory default)

16. Leave Horn Driver Mode at "NO" keeping this function disabled.

17. TAB past REGULAR TIMER MODE and SCROLL to edit time. hours/minutes/seconds (H/M/S)

18. TAB to BLINK ONE to set the first blink warning and SCROLL to set the time. minutes/seconds (M/S)

Note: Fade Rate can be set for the BLINK TIMER as well as the relay.

19. TAB to BLINK TWO to edit the second blink warning (disabled by default)

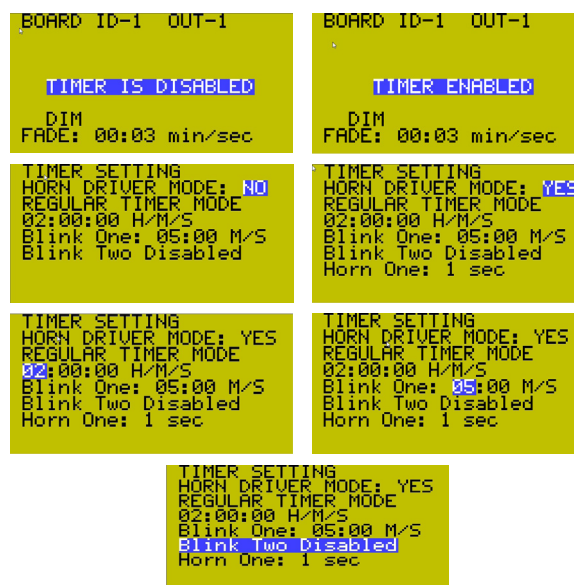

Setting Horn Driver:

20. Refer to and follow steps 13- 18.

- NO: Horn Driver is disabled
- YES: Horn Driver is enabled

21. Leave Horn Driver Mode at "NO" keeping this function disabled.

22. Exit to save changes

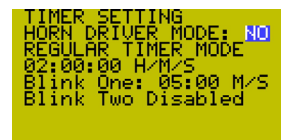

Setting Dimming and Fade Rate:

23. TAB to DIM and SCROLL to edit

By default this setting will be on DIM. You also have the options of Non Dim (switching only) and Hid.

24. TAB to the FADE RATE



25. SCROLL to edit minutes (min/sec)
26. TAB over to (min/sec)
27. SCROLL to edit seconds
28. Exit to save changes

Setting Low/High trim:

29. Starting at BOARD SETTINGS select the desired relay and press ENTER

30. TAB to DIM and press ENTER

Note: In the Trim MENU, the Low Trim value will be highlighted

31. SCROLL to edit the Low Trim.

NOTE: By default the low trim will be set to 150.

32. TAB down to High Trim.

33. SCROLL to edit the High Trim.

NOTE: The default for the High Trim is set to 910. (I got 1000)

```
Board version: 2.94
 1 2 3 4 5 6 7 8
Normally Closed
  Y Y Y Y Y Y Y Y
No Blink
  - - - - - - - -
Occ Sensor Via Bus
  Y Y Y Y Y Y Y Y
```

```
Board version: 2.94
 1 2 3
TIMER ENABLED
DIM
FADE: 00:03 min/sec
```

```
Trim menu - DIM1
Low trim: 1
High trim: 1000
Dim output when level
is zero: Zero
```

```
Trim menu - DIM1
Low trim: 1
High trim: 1000
Dim output when level
is zero: Zero
```

Setting a Blink Warning:

Setting the Blink Warning in the Relay Properties allows you to designate a single relay/dimming output. For multiple outputs with the same scheduled blink warning, see Group Programming.

34. Starting at BOARD SETTINGS TAB to NO BLINK (disabled by default) and SCROLL to edit the Blink Timer

- -: Enable blink timer for selected relay
- Y: Disable blink timer for selected relay

NOTE: A blink warning set to a single relay output will override a group blink warning.

```
BOARD 1 SETTINGS
 1 2 3 4 5 6 7 8
Normally Closed
  Y Y Y Y Y Y Y Y
No Blink
  - - - - - - - -
Occ Sensor Via Bus
  Y Y Y Y Y Y Y Y
```

Setting an Occupancy Sensor Over the Bus:

This function enables control over a single or multiple relay/dimming outputs to an occupancy sensor over the bus.

33. TAB to OCC SENSOR VIA BUS (enabled by default) and SCROLL to edit

- Y: Bus powered Occupancy Sensor is enabled
- -: Bus powered Occupancy Sensor is disabled

34. When done ENTER.

NOTE: See Digi Link programming for wiring a low voltage occupancy sensor over the bus.

```
BOARD 1 SETTINGS
 1 2 3 4 5 6 7 8
Normally Closed
  Y Y Y Y Y Y Y Y
No Blink
  - - - - - - - -
Occ Sensor Via Bus
  Y Y Y Y Y Y Y Y
```

```
BOARD ID-1 OUT-1
TIMER ENABLED
DIM
FADE: 00:03 min/sec
```

Setting the Time Out for the Occupancy Sensor Over the Bus:

This feature allows multiple relay/dimming outputs to be controlled by the same occupancy sensor but blink and time out and different fixed times.

By default the Timer will be disabled.

35. SCROLL to enable timer.

36. ENTER

37. Refer to and repeat steps 17, 18 and 19.

```
BOARD ID-1 OUT-1
TIMER IS DISABLED
DIM
FADE: 00:03 min/sec
```

```
TIMER SETTING
HORN DRIVER MODE: NO
REGULAR TIMER MODE
02:00:00 H/M/S
Blink One: 05:00 M/S
Blink Two Disabled
```

MANUAL OVERRIDE OF RELAYS

Starting at the main screen, press ENTER to get to the USER MENU

1. MANUAL OVERRIDE is highlighted (default setting) and press ENTER
2. LCP field will be highlighted
3. SCROLL to select the desired LCP
4. TAB to the LOAD field
5. SCROLL up or down to select the desired LOAD (relay) number
6. Press ENTER to toggle the status of the LOAD "on" or "off". The indicator for the LOAD will show a flat line for Off or a square for On (if controlling a dimming LOAD, the indicator will show an empty square () during the fade time*.
7. Press EXIT to return to the USER MENU screen

```
USER MENU
MANUAL OVERRIDE
REVIEW SCHEDULE
GROUP LOADS
PROGRAM SWITCH
1DIM/1DH SCENES
SETUP MENU
```

```
Name: LC PANEL 1
LCP-1 LOAD-1 DIM
1 ■ 3 ■ 5- 7- 9- 11- 13- 15-
2 ■ 4 ■ 6 ■ 8- 10- 12- 14- 16 ■
```

```
Name: CHANEL 1
LCP-1 LOAD-1 DIM
1 ■ 3 ■ 5- 7- 9- 11- 13- 15-
2 ■ 4 ■ 6 ■ 8- 10- 12- 14- 16 ■
```

```
Name: CHANEL 2
LCP-1 LOAD-2 RLY
1 ■ 3 ■ 5- 7- 9- 11- 13- 15-
2 ■ 4 ■ 6 ■ 8- 10- 12- 14- 16 ■
```

```
Name: CHANEL 2
LCP-1 LOAD-2 RLY
1 ■ 3 ■ 5- 7- 9- 11- 13- 15-
2- 4 ■ 6 ■ 8- 10- 12- 14- 16 ■
```

```
Name: CHANEL 2
LCP-1 LOAD-2 RLY
1 ■ 3 ■ 5- 7- 9- 11- 13- 15-
2 ■ 4 ■ 6 ■ 8- 10- 12- 14- 16 ■
```

```
USER MENU
MANUAL OVERRIDE
REVIEW SCHEDULE
GROUP LOADS
PROGRAM SWITCH
1DIM/1DH SCENES
SETUP MENU
```

CONTACT CLOSURE/OCCUPANCY SENSOR INPUTS:

The contact closure inputs on the control card are associated with the first 8 Scenes of the panel. These are used for hard wired control.

The functions of the input, Momentary, Toggle or Maintain are programmed in the Relay Properties.

Starting in the Board Settings menu of the Relay Properties

1. TAB to the fifth relay. "YYYYYYY" The last four relays represent scene inputs.
2. ENTER.
3. SCROLL to edit the input type. By default, this will be Momentary.
4. TAB down to "TIMER IS DISABLED"
5. SCROLL to enable timer. By default timer will be disabled.
6. Press EXIT to save the changes

```
BOARD 1 SETTINGS
 1 2 3 4 5 6 7 8
Normally Closed
  Y Y Y Y Y Y Y Y
No Blink
  - - - - - - - -
Occ Sensor Via Bus
  Y Y Y Y Y Y Y Y
```

```
BOARD 1 SETTINGS
 1 2 3
Input type: Maintain
TIMER IS DISABLED
```

```
BOARD ID-1 Scene5
Input type: Momentary
TIMER ENABLED
```

SETTING TIME AND DATE

Starting at the main screen, press ENTER to get to the USER MENU

1. TAB to SETUP MENU and press ENTER
2. TAB to SYSTEM SETUP MENU and press ENTER
3. SET TIME AND DATE is highlighted
4. Press ENTER
5. The hour is highlighted
6. SCROLL to edit time (H/M/S)
7. TAB to edit the date (day/month/year) and SCROLL to change
8. TAB to HIT ENTER and press ENTER

SYSTEM OPTIONS

Starting at the main screen, press ENTER to get to the USER MENU

1. TAB to SETUP MENU and press ENTER
2. TAB to SYSTEM SETUP MENU and press ENTER
3. TAB to SYSTEM OPTIONS and press ENTER

```
BOARD 1 SETTING
MANUAL OVERRIDE
REVIEW SCHEDULE
GROUP LOADS
PROGRAM SWITCH
IDIM/IDH SCENES
SETUP MENU
```

```
SETUP MENU
RESTRICTED
RELAY PROPERTIES
SYSTEM SETUP MENU
SCHEDULE PROPERTIES
```

```
SYSTEM SETUP MENU
SET TIME AND DATE
EDIT HOLIDAYS
SYSTEM OPTIONS
WHAT and WHEN?
ADDRESSING-BUS SCAN
```

Setting the Keyboard Lock Code:

4. KEYBOARD LOCK CODE is highlighted
 5. Press ENTER
 6. The keyboard lock code is set to '0000' by default
 7. SCROLL to edit the numbers and TAB to move to the next field
 8. Press ENTER once the code is set
 9. To change or disable the code, re-enter the code and press ENTER
- NOTE: setting the code to '0000' will disable the keyboard lock code

```
SYSTEM OPTIONS
KEYBOARD LOCK CODE
SELECT LOCATION
DISPLAY OPTIONS
DAYLIGHT SETUP
NAMING MENU
```

```
KEYBOARD LOCK CODE
IS: 0000
Set code '0000' to
disable or any other
code to enable Key
Lock permanently
Hit exit if not sure
and see Users manual.
```

Setting the Location:

10. At the SYSTEM OPTIONS, TAB to SELECT LOCATION and press ENTER
 11. LIST OF CITIES is highlighted
 12. Press ENTER
 13. SCROLL to select the city and press ENTER
- NOTE: based on the location selected, the rest of the attributes will be automatically populated. The Latitude and Longitude can be manually adjusted at the SELECT LOCATIONS menu.
14. EXIT to SYSTEM OPTIONS menu once complete.

```
SYSTEM OPTIONS
KEYBOARD LOCK CODE
SELECT LOCATION
DISPLAY OPTIONS
DAYLIGHT SETUP
NAMING MENU
```

```
SELECT LOCATION
LIST OF CITIES
LATITUDE-LONGITUDE
```

```
Los Angeles, CA
Latitude: 34°N
Longitude: 118°W
Time zone: GMT-8
To accept the above
settings... HIT ENTER
```

Personalizing the Display options:

15. TAB to DISPLAY OPTIONS and press ENTER
16. TAB to select from the list of available features.
17. Scroll to edit the various display options available.
18. Before exiting SYSTEM OPTIONS, TAB down to HIT ENTER (press enter) to save settings
19. EXIT to SYSTEM OPTIONS menu once complete.

```
SYSTEM OPTIONS
KEYBOARD LOCK CODE
SELECT LOCATION
DISPLAY OPTIONS
DAYLIGHT SETUP
NAMING MENU
```

```
Military Time: NO
Seconds Visible: YES
Daylight Saving: YES
Temperature F/C: °F
RS-232 K-BAUD: 57.6
Modem mode: 0
Photocell mode: NEW
To save: HIT ENTER
```

```
Military Time: NO
Seconds Visible: YES
Daylight Saving: YES
Temperature F/C: °F
RS-232 K-BAUD: 57.6
Modem mode: 0
Photocell mode: NEW
To save: HIT ENTER
```

Setting Daylight Parameters:

- TAB to DAYLIGHT SETUP and press ENTER
- At the DAYLIGHT PARAMETERS menu, TAB to select the date when daylight starts/ends and SCROLL to edit
- EXIT to SYSTEM OPTIONS menu once complete.

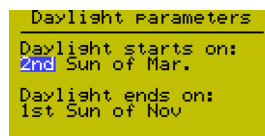

Setting Names for Groups, Schedules, Panel/Loads or Switches/Buttons on the bus:

- TAB to NAMING MENU and press ENTER
- TAB down to the specific parameter and press ENTER

NOTE: Naming Parameter

- GROUP NAMES
- SCHEDULE NAMES
- PANEL-LOAD NAME
- SWITCH-BUTTON NAMES

- TAB or select to edit pre-set name and press ENTER
- TAB to the number position in the name.
- Scroll to choose different numbers.
- EXIT when done.

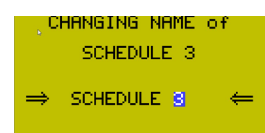
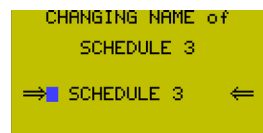
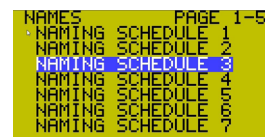
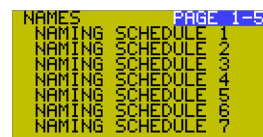

EDIT HOLIDAYS

Starting at the main screen, press ENTER to get to the USER MENU

- TAB to SETUP MENU and press ENTER
- TAB to SYSTEM SETUP MENU and press ENTER
- TAB to EDIT HOLIDAYS and press ENTER
- HOLIDAY LIST 1 is highlighted, press ENTER
- PAGE 1 is highlighted
- SCROLL to edit the page
- TAB to the Holiday on the list to be edited and SCROLL to enable the selected Holiday (NO/YES)
- Press EXIT to save changes and SCROLL to YES/NO and press ENTER
- Repeat the steps above to edit HOLIDAY LIST 2

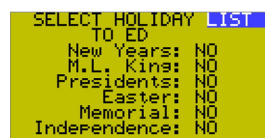
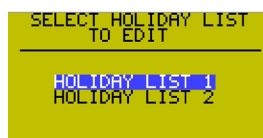
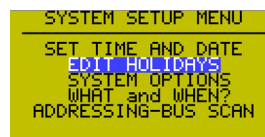
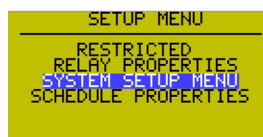
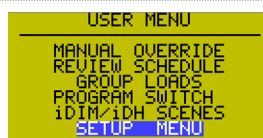

BUTTON / INPUT CONTROL FUNCTIONS

Programming Switch Buttons

Starting at the main screen, press ENTER to get to the USER MENU

- TAB to PROGRAM SWITCH and press ENTER
- TAB to the desired switch ID number and press ENTER.
- TAB to the switch button number you want to program and press ENTER.

NOTE: If there are more than 6 buttons on the switch, use the Page number field at the top right of the screen to select the next set of buttons.

- The control function field will be highlighted, SCROLL to the desired control function (Refer to CONTROL FUNCTIONS explained above).
- TAB to LCP field and SCROLL to the desired LCP number (1, 2, 3 etc.).
- TAB to LOAD field
- SCROLL to the desired LOAD
- Press ENTER to add /delete the LOAD to/from the list
- SCROLL to next LOAD and press ENTER to add / delete more LOADS on the same LCP.
- Repeat steps 5-9 to add /delete LOADS for additional LCPs. Note: If more than 8 LOADS are assigned to a button, the screen will display a message, allowing the user to select No/Yes to automatically create a GROUP when exiting. If No is selected, all changes will be discarded. Button settings can only be edited in GROUP LOADS once the GROUP is created.
- Press EXIT when complete.
- Repeat steps 2-11 to program the next button

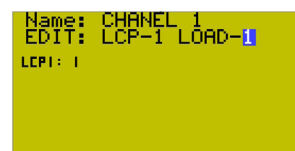
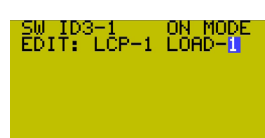
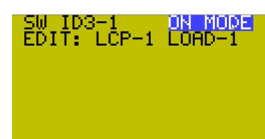
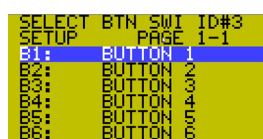

Programming Photocell Cards:

Starting at the main screen, press ENTER to get to the USER MENU

13. TAB to PROGRAM SWITCH and press ENTER

14. TAB to the desired photocell card ID number and press ENTER.

15. TAB to the trigger number you want to program and press ENTER.

16. The control function field will be highlighted, SCROLL to the desired control function (Refer to CONTROL FUNCTIONS explained above).

17. TAB to LCP field and SCROLL to the desired LCP number (1, 2, 3 etc.).

18. TAB to LOAD field

19. SCROLL to the desired LOAD

20. Press ENTER to add /delete the LOAD to/from the list
21. SCROLL to next LOAD and press ENTER to add / delete more LOADs on the same LCP.

22. Repeat steps 5-9 to add /delete LOADs for additional LCPs. Note: If more than 8 LOADs are assigned to a button, the screen will display a message, allowing the user to select No/Yes to automatically create a GROUP when exiting. If No is selected, all changes will be discarded. Button settings can only be edited in GROUP LOADS once the GROUP is created.

23. Press EXIT when complete.

24. Repeat steps 2-11 to program the next trigger.

```

USER MENU
-----
MANUAL OVERRIDE
REVIEW SCHEDULE
GROUP LOADS
PROGRAM SWITCH
1DIM/1DH SCENES
SETUP MENU
    
```

```

SWITCHES PAGE 1-1
#3: SWITCH 3
#13:PHOTOCELL 13
    
```

```

SELECT BTN SWI ID#13
PAGE 1-3
T1: TRIGGER 1
T2: TRIGGER 2
T3: TRIGGER 3
T4: TRIGGER 4
T5: TRIGGER 5
T6: TRIGGER 6
    
```

```

SELECT BTN SWI ID#13
PAGE 1-3
T1: TRIGGER 1
T2: TRIGGER 2
T3: TRIGGER 3
T4: TRIGGER 4
T5: TRIGGER 5
T6: TRIGGER 6
    
```

```

SW ID13-1 ON MODE
EDIT: LCP-1 LOAD-1
    
```

```

Name: LC PANEL 1
EDIT: LCP-1 LOAD-1
    
```

```

SW ID13-1 ON MODE
EDIT: LCP-1 LOAD-1
    
```

```

SW ID13-1 ON MODE
EDIT: LCP-1 LOAD-1
LCP: 1
    
```

Programming a DigiLink:

To program a digi link you will be bus mapping a 14 button or a 6 button switch depending the digi link.

- D14- Fourteen dry contacts programmable to control any combination of relay outputs.
- D6- Six dry contacts programmable to control any combination of relay outputs.

After bus mapping the appropriate digi link, refer to and repeat steps 1-12.

NOTE: Digi links will be used when wiring occupancy sensors over the bus, along with any other contact closure switches.

See Occupancy Sensor wiring diagrams for wiring details.

```

USER MENU
-----
MANUAL OVERRIDE
REVIEW SCHEDULE
GROUP LOADS
PROGRAM SWITCH
1DIM/1DH SCENES
SETUP MENU
    
```

```

SWITCHES PAGE 1-1
#3: SWITCH 3
#4: SWITCH 4
#13:PHOTOCELL 13
    
```

```

SELECT BTN SWI ID#4
SETUP PAGE 1-3
B1: BUTTON 1
B2: BUTTON 2
B3: BUTTON 3
B4: BUTTON 4
B5: BUTTON 5
B6: BUTTON 6
    
```

```

SELECT BTN SWI ID#4
SETUP PAGE 1-3
B1: BUTTON 1
B2: BUTTON 2
B3: BUTTON 3
B4: BUTTON 4
B5: BUTTON 5
B6: BUTTON 6
    
```

```

SW ID4-1 ON MODE
EDIT: LCP-1 LOAD-1
    
```

```

Name: LC PANEL 1
EDIT: LCP-1 LOAD-1
    
```

```

SW ID4-1 ON MODE
EDIT: LCP-1 LOAD-1
    
```

```

Name: CHANEL 1
EDIT: LCP-1 LOAD-1
LCP: 1
    
```

SCHEDULE PROGRAMMING

To program the schedules:

Starting at the main screen, press ENTER to get to the USER MENU

1. TAB down to REVIEW SCHEDULE and press ENTER
2. PAGE 1-6 is highlighted
3. SCROLL to choose desired page
4. TAB to highlight SCH # to edit and press ENTER
5. EXCEPT NONE is highlighted
6. SCROLL to select mode EXCEPT NONE: No holiday schedules EXCEPT H1: Holiday List 1 activated EXCEPT H2: Holiday List 2 activated EXCEPT H1+H2: Holiday List 1 and 2 activated
7. TAB to EVERY DAY

```

SCH 1 EXCEPT NONE
MONDAY-FRIDAY
ON TIME: 09:00am
OFF TIME: 05:00pm
SAT ON TIME: 09:00am
OFF TIME: 05:00pm
SUN ON TIME: 09:00am
OFF TIME: 05:00pm
    
```

```

SCH 1 BY DAY H1 H2
Mo Tu We Th Fr Sa Su
Select days to
edit or review.
from Jan 1 to Dec 31
    
```

```

USER MENU
-----
MANUAL OVERRIDE
REVIEW SCHEDULE
GROUP LOADS
PROGRAM SWITCH
SETUP MENU
    
```

```

SCHEDULES PAGE 1-6
SCH 1 UNUSED
SCH 2 UNUSED
SCH 3 UNUSED
SCH 4 UNUSED
SCH 5 UNUSED
SCH 6 UNUSED
    
```

```

SCHEDULES PAGE 2-8
SCH 7 UNUSED
SCH 8 UNUSED
SCH 9 UNUSED
SCH 10 UNUSED
SCH 11 UNUSED
SCH 12 UNUSED
    
```

```

SCHEDULES PAGE 2-8
Name: SCHEDULE 7
SCH 7 UNUSED
SCH 8 UNUSED
SCH 9 UNUSED
SCH 10 UNUSED
SCH 11 UNUSED
SCH 12 UNUSED
    
```

8. SCROLL to select mode:

- EVERY DAY: Same schedule 7 days a week
- MONDAY-FRIDAY: Same schedule Monday through Friday, alternate schedules Saturday and Sunday
- DAY BY DAY: Daily schedule varies

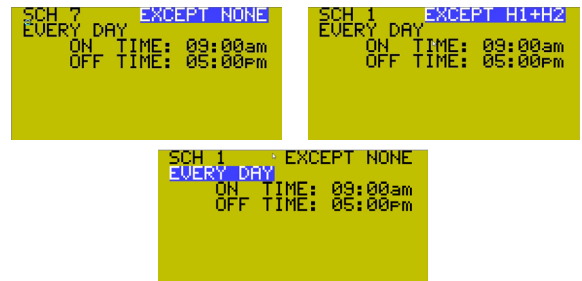

PROGRAMMING SCHEDULES - EVERY DAY

1. TAB to ON/OFF TIME field
2. SCROLL to select preferred settings:
 - TIME: ON/OFF by time of day
 - DAWN: ON/OFF by astronomical sunrise +/- offset time (H/M)
 - DUSK: ON/OFF by astronomical sunset +/- offset time (H/M)
 - NONE: No ON/OFF time

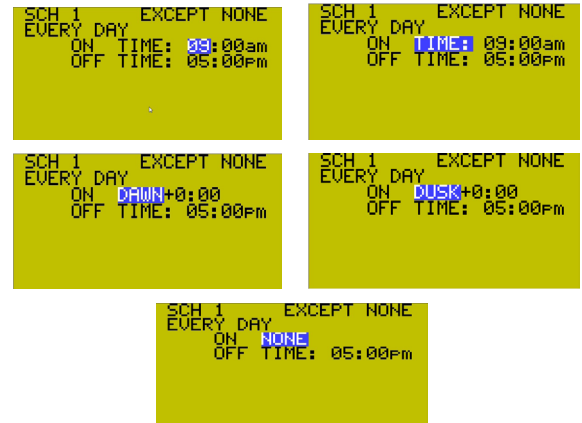

NOTE: this function assumes another device such as a photocell will trigger the controlled group on or off when appropriate. Do not create schedules with just a single on or off event. The group controlled may not operate as expected.

SETTING MULTIPLE SCHEDULES - BY DAY and MONDAY-FRIDAY

1. TAB down to {EVERY DAY} enter
2. SCROLL down to choose to program schedules for: BY DAY/ MONDAY -FRIDAY
3. TAB to select day and press ENTER (if applicable)
4. TAB down to {ON TIME:} or {OFF TIME:}
5. SCROLL to edit the time

NOTE: When all the steps of creating a schedule have been completed needs to move on to selecting and creating groups. See Group Programming.

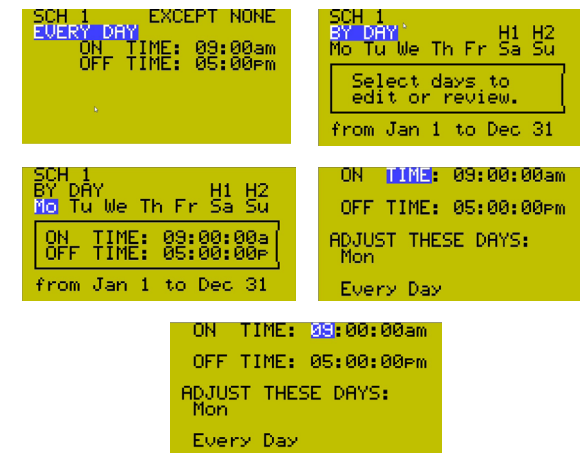

PROGRAMMING THE GROUPS

Starting at the main screen, press ENTER to get to the USER MENU

1. TAB to GROUP LOADS and press ENTER
2. TAB to the desired GROUP and press ENTER
3. The control function field will be highlighted, SCROLL to the desired control function.
4. TAB to LCP field and SCROLL to the desired LCP number (1,2,3 etc.).
5. TAB to LOAD field
6. SCROLL to the desired LOAD
7. Press ENTER to add /delete the LOAD to/from the list
8. SCROLL to next LOAD and press ENTER to add / delete more LOADs on the same LCP.
9. Repeat steps 6-8 to add /delete LOADs for additional LCPs.
10. Press EXIT when complete.



Testing group functions: This will toggle each load assigned to that group and raise or lower the associated dimming output. Once Groups are set, starting at Group Loads Menu.

- TAB down to the first group used.
- Scroll up to turn the group "ON"
- Scroll down to turn the group "OFF"

NOTE: If you have a long fade rate set on that dimming output channel (See Relay Properties) you will see a delay in the Loads turning off from when you turn the group off.

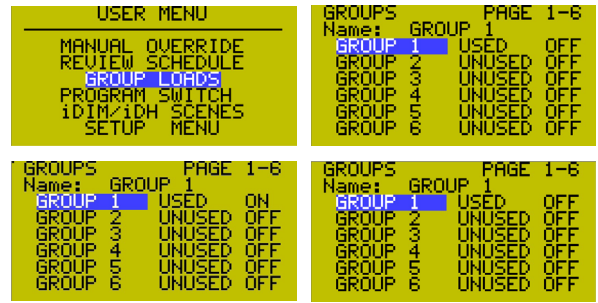

SCENE PROGRAMMING

Starting at the main screen, press ENTER to get to the USER MENU

1. TAB to IDIM/IDH SCENES and press ENTER
2. LCP field will be highlighted
3. SCROLL to change the LCP
4. TAB down to desired SCENE
5. SCROLL to select the preferred SCENE function:

- SCENE
- RAISE
- LOWER
- FREEZE
- NO AUTO
- ReStart
- FLIP-11
- PROGRAM

6. Press ENTER to edit the SCENE

NOTE: Only LCP numbers of devices utilizing scene functions (Bluebox LTD, Micropanel, X point dim, etc.) will be displayed in this field.

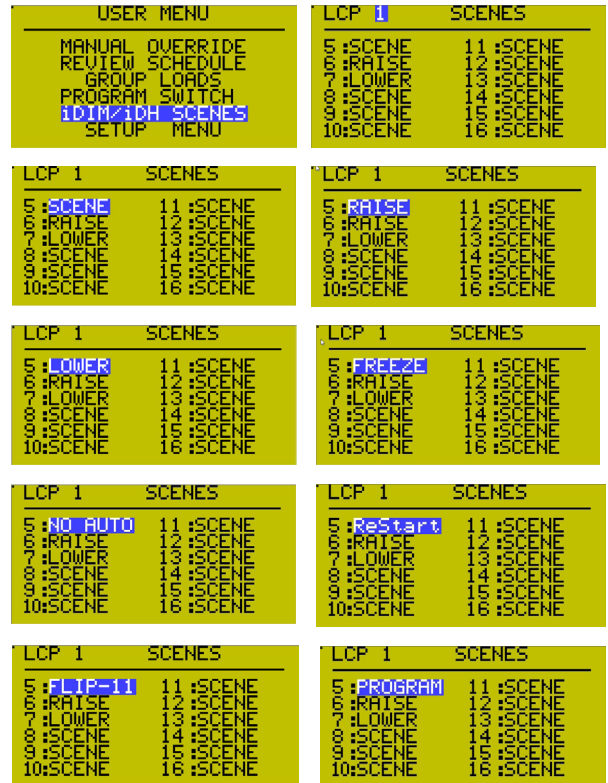

PROGRAMMING SCENES - SCENE

Editing Timer Values:

1. TAB down to desired SCENE
2. SCROLL to select the SCENE function
3. Press ENTER to edit the SCENE
4. NO TIMER field is highlighted
5. SCROLL on the field to activate/deactivate the delay to off timer
6. When Set to "TIMER", TAB down to the delay time (H/M/S)
7. CROLL to change the values

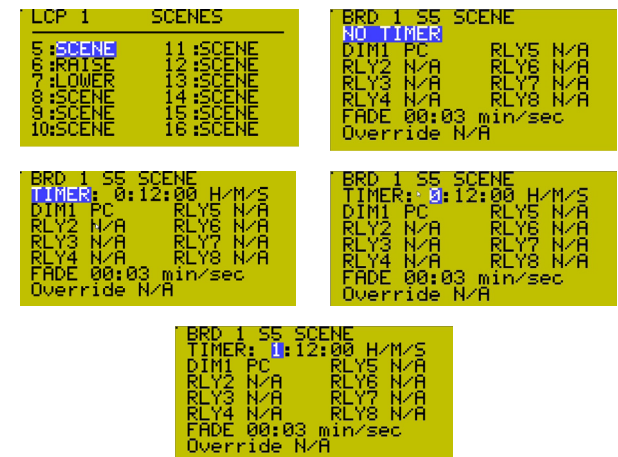

Editing the Dimming/Relay outputs:

8. TAB to select the output channel to edit
9. SCROLL to select the function or Dimming value (shown below)
 - 0-100%: Fixed value for output channel when SCENE is activated.



NOTE: You can also tap ENTER to jump in increments of 10 when setting the fixed value.

• PC: Output channel is controlled by Photocell when SCENE is activated. Press ENTER to edit Photocell settings. Refer to Photocell Programming below.

- N/A: Output channel is not affected when SCENE is activated
- 0% value equals OFF.

```
BRD 1 S5 SCENE
TIMER: 1:12:01 H/M/S
DIM1 N/A RLY5 N/A
RLY2 N/A RLY6 N/A
RLY3 N/A RLY7 N/A
RLY4 N/A RLY8 N/A
```

```
BRD 1 S5 SCENE
TIMER: 1:12:01 H/M/S
DIM1 0% RLY5 N/A
RLY2 N/A RLY6 N/A
RLY3 N/A RLY7 N/A
RLY4 N/A RLY8 N/A
FADE 00:03 min/sec
```

Photocell Programming:

1. Pcell (input) field is highlighted. Press ENTER
2. SCROLL to select Local Photocell input (IN1-IN4) or Global Photocell address/input number, if installed. Photocell light level is shown next to the Pcell input field. Note: Unused Local Photocell input will display a light level value of 1000.
3. TAB to FADE UP/FADE DOWN fields to edit Photocell fade rate (min/sec). Default setting is 20 seconds.
4. SCROLL to set the fade time

NOTE: The default fade rate is 3 seconds. Fade rate is set in minutes and seconds up to 99 minutes and 59 seconds. This is the rate at which the output channel dims up or down from 0 to 100%.

5. TAB to OFF(END) value and SCROLL to select OFF: Turns off output channel when output level equals 0 END: Output channel goes to minimum dim level and remains ON

NOTE: minimum dim level for each channel can be set using the trim function in the relay properties settings. See Relay Properties.

6. TAB to START/MID/OFF(END) fields to edit the Photocell response curve START: Output channel begins to dim MID: Output channel curve mid-point OFF (END): Output channel minimum level
7. SCROLL to change value by 1. To increment by 10, the number cannot end in a 0. Press ENTER. To increment by 100, the number must end in a 0. Press ENTER.
8. TAB to TIME FROM OFF field (the time the Photocell is deactivated once it reaches the minimum dim level, to prevent short cycling on cloudy days).
9. SCROLL to select delay time (min/sec)
10. TAB to MUST TURN ON field (minimum light level to immediately release TIME FROM OFF delay). Must be lower than the Photocell response curve START value.
11. SCROLL to select light level
12. EXIT to previous menu

```
BOARD 1 Sc5-DIM1
Pcell IN1 1000
Fade UP 00:20 min/sec
FADE DN 00:20 min/sec
START MID OFF
50 100 200
Time from OFF 05:00
Must Turn ON 125
```

```
BOARD 1 Sc5-DIM1
Pcell IN1 1000
Fade UP 00:20 min/sec
FADE DN 00:20 min/sec
START MID OFF
50 100 200
Time from OFF 05:00
Must Turn ON 125
```

```
BOARD 1 Sc5-DIM1
Pcell IN1 1000
Fade UP 00:20 min/sec
FADE DN 00:20 min/sec
START MID OFF
51 200 200
Time from OFF 05:00
Must Turn ON 125
```

```
BOARD 1 Sc5-DIM1
Pcell IN1 1000
Fade UP 00:20 min/sec
FADE DN 00:20 min/sec
START MID OFF
150 200 200
Time from OFF 05:00
Must Turn ON 125
```

```
BOARD 1 Sc5-DIM1
Pcell IN1 1000
Fade UP 00:20 min/sec
FADE DN 00:20 min/sec
START MID OFF
150 200 200
Time from OFF 01:00
Must Turn ON 125
```

```
BOARD 1 Sc5-DIM1
Pcell IN1 1000
Fade UP 00:20 min/sec
FADE DN 00:20 min/sec
START MID OFF
150 200 200
Time from OFF 01:00
Must Turn ON 100
```

```
BRD 1 S5 SCENE
TIMER: 0:12:00 H/M/S
DIM1 0% RLY5 N/A
DIM2 N/A RLY6 N/A
DIM3 N/A RLY7 N/A
DIM4 N/A RLY8 N/A
FADE 00:04 min/sec
Override N/A
```

```
BRD 1 S5 SCENE
TIMER: 3:12:01 H/M/S
DIM1 0% RLY5 N/A
RLY2 N/A RLY6 N/A
RLY3 N/A RLY7 N/A
RLY4 N/A RLY8 N/A
FADE 00:03 min/sec
Override N/A
```

```
BOARD 1 Sc5-DIM1
Pcell IN1 0
Fade UP 00:01 min/sec
FADE DN 00:01 min/sec
START MID OFF
50 100 200
Time from OFF 00:00
Must Turn ON 125
```

```
BOARD 1 Sc5-DIM1
Pcell IN1 0
Fade UP 01:01 min/sec
FADE DN 00:01 min/sec
START MID OFF
50 100 200
Time from OFF 00:00
Must Turn ON 125
```

PROGRAMMING SCENE - RAISE/LOWER

1. TAB to SCENE
2. SCROLL to select the SCENE function RAISE/LOWER and press ENTER
3. Output channel DIM1 (SCENES 5-8) or MAX/MIN field (SCENES 9-16) is highlighted
4. SCROLL to select the function (shown below) N/A: Output channel is not affected when SCENE is activated

```
LCP 1 SCENES
5: SCENE 11: PROGRAM
6: PROGRAM 12: PROGRAM
7: NO AUTO 13: PROGRAM
8: PROGRAM 14: PROGRAM
9: PROGRAM 15: PROGRAM
10: PROGRAM 16: PROGRAM
```

```
LCP 1 SCENES
5: RAISE 11: PROGRAM
6: LOWER 12: PROGRAM
7: PROGRAM 13: PROGRAM
8: PROGRAM 14: PROGRAM
9: PROGRAM 15: PROGRAM
10: PROGRAM 16: PROGRAM
```

RAISE: (Only available if raise scene function is selected.)

Dimming output channel will raise from its current value for the duration the SCENE is activated. MAX: SCENES 9-16 have the option to operate at full range (0-100%) or be limited by the light level set by the selected Photocell SCENE (SCENES 5-8) ON: Non-dimming output channel turns on when the SCENE is activated.

```
BRD 1 S5 RAISE
DIM1 N/A RLY5 N/A
DIM2 RAISE RLY6 N/A
DIM3 N/A RLY7 N/A
DIM4 N/A RLY8 N/A
FADE 00:04 min/sec
Tap Jump: 25%
```

```
BRD 1 S5 RAISE
DIM1 RAISE RLY5 N/A
DIM2 RAISE RLY6 N/A
DIM3 N/A RLY7 N/A
DIM4 N/A RLY8 N/A
FADE 00:04 min/sec
Tap Jump: 25%
```

LOWER: (Only available if lower scene function is selected.)

Dimming output channel lowers from its current value for the duration the SCENE is activated. MIN: Dimming output channel turns

```
BRD 1 S5 LOWER
MIN OFF
DIM1 LOWER RLY5 N/A
DIM2 LOWER RLY6 N/A
DIM3 N/A RLY7 N/A
DIM4 N/A RLY8 N/A
FADE 00:04 min/sec
Tap Jump: 25%
```

off the relay at 0 output (OFF) or remains on at minimum trim level (1%) OFF: Non-dimming output channel turns off when the SCENE is activated. (Scene function for lower 9-16)

Setting the Fade Rate: This is the rate at which the output channel goes from 0-100%.

- 5. TAB to FADE RATE: The default fade rate is 3 seconds. Fade rate is set in minutes and seconds up to 99 minutes and 59 seconds.
- 6. SCROLL to edit (min/sec)

```
BRD 1 S5 LOWER
MIN OFF
DIM1 LOWER RLY5 N/A
DIM2 LOWER RLY6 N/A
DIM3 N/A RLY7 N/A
DIM4 N/A RLY8 N/A
FADE 00:03 min/sec
Tap JUMP: 25%
```

```
BRD 1 S5 LOWER
MIN OFF
DIM1 LOWER RLY5 N/A
DIM2 LOWER RLY6 N/A
DIM3 N/A RLY7 N/A
DIM4 N/A RLY8 N/A
FADE 00:03 min/sec
Tap JUMP: N/A
```

Setting the Tap Jump Function: The Tap Jump Function will allow you to lower or raise the output levels but a set percentage, with a single tap of a button on a digital switch or contact closure.

- 7. TAB to TAP JUMP
- 8. SCROLL to N/A or percent value (factory default is N/A)
N/A: Continuous fade of light output when SCENE is activated
- 9. EXIT to SCENES menu

```
BRD 1 S5 LOWER
MIN OFF
DIM1 LOWER RLY5 N/A
DIM2 LOWER RLY6 N/A
DIM3 N/A RLY7 N/A
DIM4 N/A RLY8 N/A
FADE 00:03 min/sec
Tap JUMP: 10%
```

```
LCP 1 SCENES
5: LOWER 11:PROGRAM
6: LOWER 12:PROGRAM
7:PROGRAM 13:PROGRAM
8:PROGRAM 14:PROGRAM
9:PROGRAM 15:PROGRAM
10:PROGRAM 16:PROGRAM
```

PROGRAMMING SCENE - FREEZE

- 1. TAB to SCENE
- 2. SCROLL to select the SCENE function FREEZE and press ENTER
- 3. The SCENE to be frozen (ON SCENE) is highlighted
- 4. SCROLL to select the SCENE number
- 5. TAB to LOCK OUT BUS
- 6. SCROLL to edit (NO/YES)
- 7. TAB to NO TIMER/TIMER field
- 8. SCROLL to select mode

NOTE: activating this feature will prevent the selected scene from being changed by commands from network devices such as switches, time schedules, contact closure input devices, etc

```
LCP 1 SCENES
5: FREEZE 11:PROGRAM
6: LOWER 12:PROGRAM
7:PROGRAM 13:PROGRAM
8:PROGRAM 14:PROGRAM
9:PROGRAM 15:PROGRAM
10:PROGRAM 16:PROGRAM
```

```
BRD 1 S5 FREEZE
On Scene 5:
Ignores PCELL & OCC.
Lock out bus: No
until cancel
then returns to
scene.
TIMER: 0:12:00 H/M/S
```

```
BRD 1 S5 FREEZE
On Scene 6:
Ignores PCELL & OCC.
Lock out bus: No
until cancel
then returns to
scene.
TIMER: 0:12:00 H/M/S
```

```
BRD 1 S5 FREEZE
On Scene 6:
Ignores PCELL & OCC.
Lock out bus: Yes
until cancel
then returns to
scene.
TIMER: 0:12:00 H/M/S
```

```
BRD 1 S5 FREEZE
On Scene 6:
Ignores PCELL & OCC.
Lock out bus: Yes
until cancel
then returns to
scene.
TIMER: 0:12:00 H/M/S
```

Setting the Timer values:

- 9. In TIMER mode TAB to edit timer values (H/M/S) and SCROLL to edit time. hours/minutes/seconds (H/M/S)
- 10. EXIT to SCENES menu

NOTE: if activated this timer will count down for the period shown and automatically unfreeze the controlled scene at the end of the time delay. If the timer function is not activated the controlled scene will remain frozen until manually release.

```
BRD 1 S5 FREEZE
On Scene 6:
Ignores PCELL & OCC.
Lock out bus: Yes
until cancel
then returns to
scene.
TIMER: 0:12:00 H/M/S
```

```
BRD 1 S5 FREEZE
On Scene 6:
Ignores PCELL & OCC.
Lock out bus: Yes
until cancel
then returns to
scene.
TIMER: 0:12:00 H/M/S
```

```
LCP 1 SCENES
5: FREEZE 11:PROGRAM
6: LOWER 12:PROGRAM
7:PROGRAM 13:PROGRAM
8:PROGRAM 14:PROGRAM
9:PROGRAM 15:PROGRAM
10:PROGRAM 16:PROGRAM
```

PROGRAMMING SCENE - PROGRAM

- 1. TAB to SCENE
- 2. SCROLL to select the SCENE function PROGRAM and press ENTER
- 3. First output channel is highlighted
- 4. TAB to select initial default preset levels Note: Initial preset light levels may be set in the programming or the active channel may be selected by changing the value (non N/A) to allow storing preset light level with a push button
- 5. Refer to PROGRAMMING SCENES- SCENE for additional programming steps.

NOTE: leaving a control channel set for N/A will prevent that channel from storing light levels.

```
LCP 1 SCENES
5: PROGRAM 11:PROGRAM
6: LOWER 12:PROGRAM
7:PROGRAM 13:PROGRAM
8:PROGRAM 14:PROGRAM
9:PROGRAM 15:PROGRAM
10:PROGRAM 16:PROGRAM
```

```
BRD 1 S5 PROGRAM
DIM1 100% RLY5 N/A
DIM2 1% RLY6 N/A
DIM3 N/A RLY7 N/A
DIM4 N/A RLY8 N/A
FADE 00:03 min/sec
```

BLUE BOX™ LTD

OCCUPANCY SENSOR HOOK UP

OCCUPANCY SENSOR OVERVIEW

We recommend using occupancy sensors provided by Acuity Brands. Occupancy sensors may be powered by the regulated 24 V dc/300 mA supply on the control card. You can use pull-high, pull-low or contact closure occupancy sensors.

WARNING: Do not use line voltage output occupancy sensors.

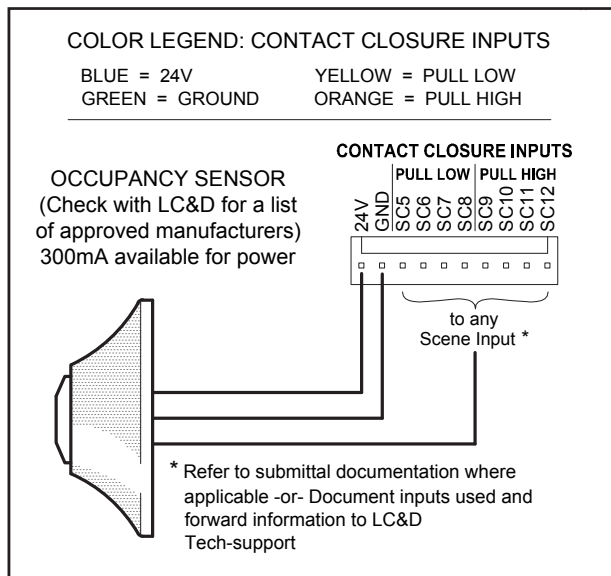

OVERRIDE SWITCHES

The quickest and easiest way to add an override switch is to connect a digital GR2400 switch to the same bus. The switch can be programmed from the DTC or by the factory over a phone line connection.

If a hard wired switch is being used, then the type of switch must be specified in the Relay Properties menu. (See Blue Box LTD Programming Guide for programming details)

| Devices | Signal | Termination | Input Type |
|--|---------------------------|-------------|---|
| Occupancy Sensor (Pull-Low) | Normally open/contact out | Scene 5-8 | Maintain |
| | Common | GND | |
| | Power in | 24 Volt | |
| Occupancy Sensor (Pull-High) | Control output | Scene 9-12 | Maintain |
| | Common | GND | |
| | Power in | 24 Volt | |
| Maintained, Toggle or Momentary Switch | Output signal | Scene 5-8 | Maintain, Toggle or Momentary (as applicable) |
| | Ground | GND | |

MULTIPLE OCCUPANCY SENSORS

If more than one Occupancy Sensor is being used, the sensors can be wired in parallel if controlling the same lighting zone. If sensors are controlling different lighting zones then use different scene inputs.



Support (800)345-4448
 www.acuitycontrols.com

©2015 Acuity Brands Lighting. All Rights Reserved. Rev. 2.6.2015

BLUE BOXTM LTD

TROUBLESHOOTING WITH AN OSCILLOSCOPE

USING AN OSCILLOSCOPE TO TEST A DIGITAL BUS

In troubleshooting a system or a bus, the “Final Activation Checklist” is always the first and most important step. An Oscilloscope is a visual aid to troubleshoot the bus better.

The Oscilloscope will let one test the stability of the bus while everything is powered up. This will show if the bus is getting noise, how clean the bus signal is, if the bus is properly terminated, if there is a bad device present on the bus, and give an indication of crimp quality.

Below are some examples where the use of an Oscilloscope is definitely needed:

1. The Hardware Activation Tests included the Blue Box LTD Quick Start Guide passed, but when the system is powered up, devices appear/disappear on the bus scan.
2. The Hardware Activation Tests passed, but some devices don't seem to be working if the bus is connected, and the same devices work perfectly fine when connected directly to a master panel.
3. Everything else was checked (The Hardware Activation Tests passed and all devices are good) but the bus is still unstable.

HOW TO SETUP THE OSCILLOSCOPE FOR TESTING

Make sure the Oscilloscope is not earth grounded in any way. A battery powered scope or isolated input type is highly recommended.

1. Connect the probe leads to the system's A & B terminals; A “Bus Checker Card” may be used to make the testing easier. Attach the alligator clip (which is the ground lead of the probe) to the bus checker card's B terminal, then connect the main probe lead (which is usually a retractable hook tip) to the bus checker card's A terminal.
2. Adjust the vertical & horizontal controls accordingly and set the input coupling to DC. You should be able to see your bus signal which is a “Square Wave Signal.”
3. The advisable setting would be “1.0 volts/div” & “20 μ s to 50 μ s sec/div”. This setting should display a decent size waveform on the screen (10-1 Probe).
4. A completely “Stable Bus” should show a clean & balanced square wave signals. The baseline must be centered at “0V” and never changes.
5. If the bus is not terminated properly, some “ringing” may be seen. With less loading, the Vpp is higher. If there are no bad devices, the baseline is still at 0V.

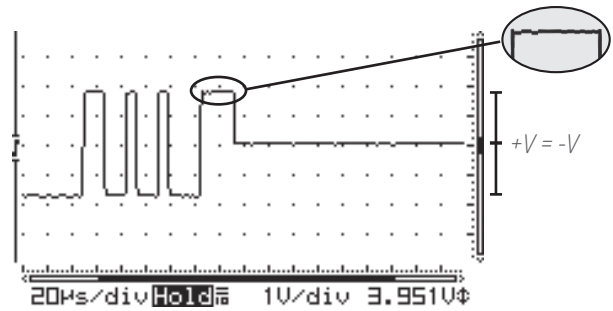
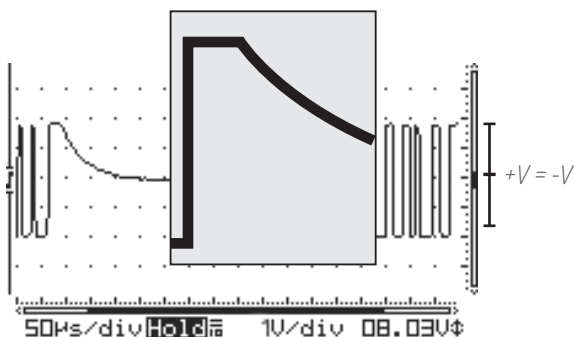

Ideal wave form; Square waves with no ring or dampening means the bus is terminated. +V = -V means no bad devices.

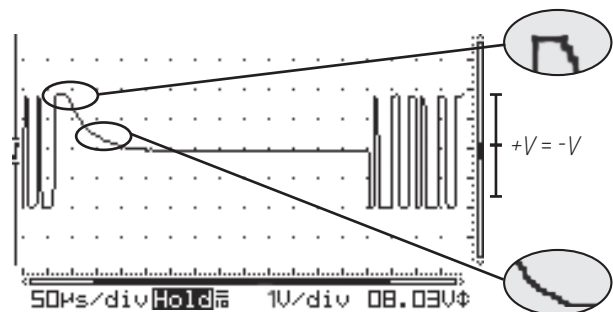

Problematic: Dampened square wave means the bus is missing one or both terminators. +V = -V means no bad devices.

6. With a partially bad device, it is sometimes hard to distinguish because it looks very similar to a good bus. One has to carefully examine the waveform and see if the baseline is centered at 0V.
7. A bad device cause the baseline to shift and the bus becomes unbalanced. (Baseline is not at 0V anymore). Below are three examples where A & B are not equal.
8. Use the Bus-Splitting technique to find the problem.

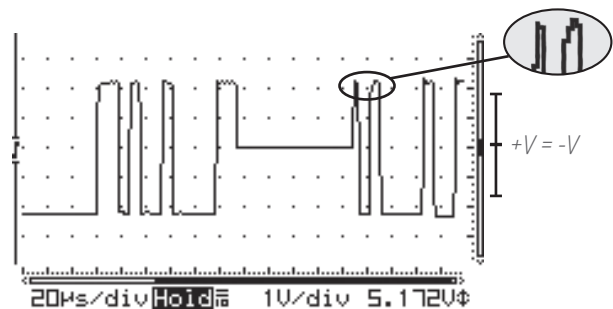

Problematic: Ringing on peak of square wave means the bus is missing one or both terminators. +V = -V means no bad devices.

USING AN OSCILLOSCOPE TO TEST A DIGITAL BUS (Continued)

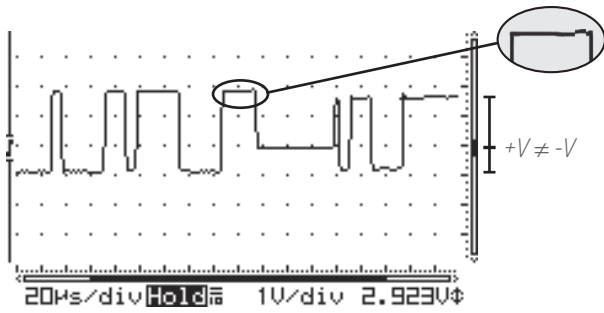

Problematic: Clean square waves mean the bus is terminated. But $+V \neq -V$ means damaged devices. Usually caused by over-voltage: static, lightning, or line voltage.

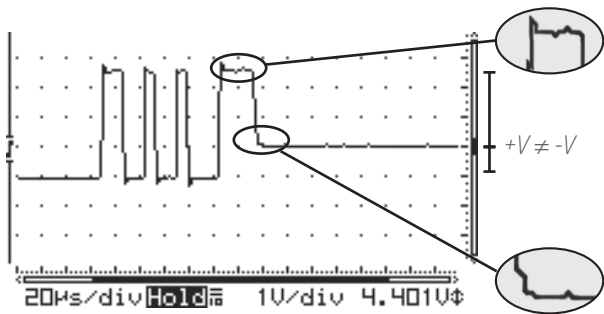

Problematic: Ringing and dampened square wave means that the bus is missing one or both terminators. $+V \neq -V$ means damaged devices. Usually caused by over-voltage: static, lightning, or line voltage.

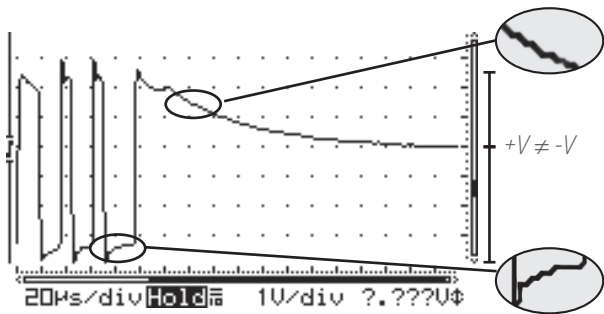

Problematic: Ringing and extremely dampened square wave means the bus is missing one or both terminators. $+V \neq -V$ means damaged devices. Usually caused by over-voltage: static, lightning, or line voltage.

BUS SPLITTING TECHNIQUE

! Note: To speed up troubleshooting when readings are less than 200Ω **■** on the Continuity or Short-Circuit test, refer to the “Bus Length Chart” before splitting the bus; this can provide an approximate distance to a shorted pair or extra terminator from the test point.

1. On the middle device of the bus, disconnect one Cat. 5 cable to create two smaller “half-buses”.
2. Test each “half-bus” to find the side with the out-of-range values.
3. Repeat steps 1 & 2 on the out-of-range “half-bus,” to create another “half-bus” until the cable, crimp or device creating the out of range measurements is located.

The idea is to split a bus in half, then half again – over and over until the bad area has been located. It is also OK to visually inspect each cable, crimp or device to detect the problem.

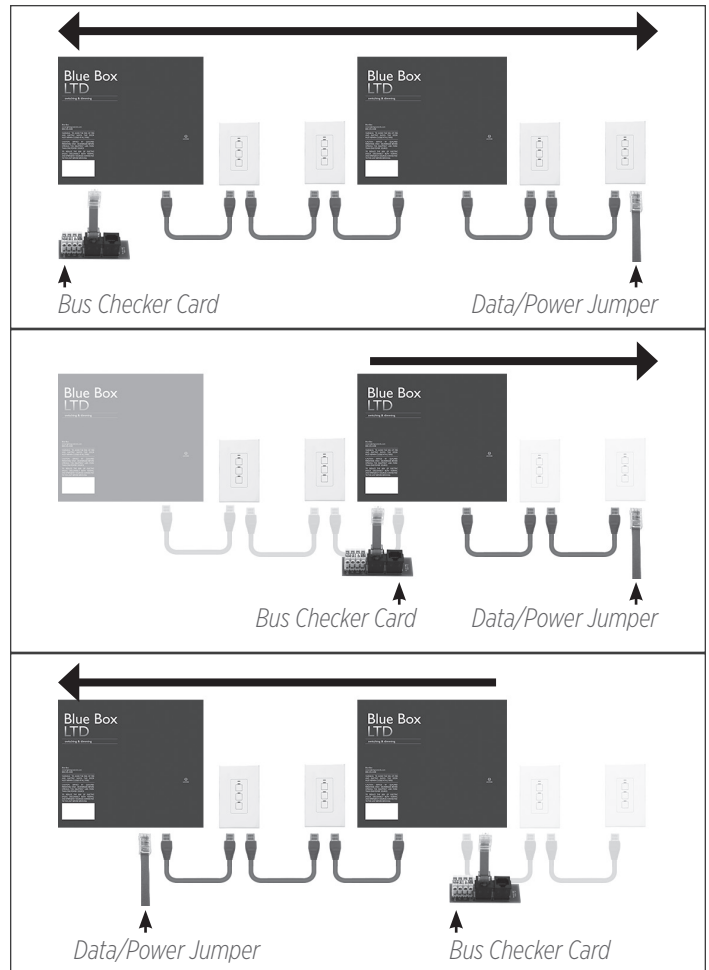

BLUE BOX™ LTD

PHOTOCELL HOOK UP GUIDE

INTRODUCTION

PCELL 3WI TZ (3 WIRE LOCAL INDOOR PHOTOCELL), PCELL 2WI (2 WIRE GLOBAL INDOOR PHOTOCELL) AND PCELL 2WO (2 WIRE GLOBAL OUTDOOR PHOTOCELL)

The PCELL 3WI TZ is connected directly to the analog inputs of a Blue Box LTD card. Typically 3 # 18 wires are used for runs of up to 150 ft from Blue Box LTD. Longer distances may require the use of shielded wires and/or heavier guage conductors .

The PCELL 2WI/2WO are two wire photocells that connect to a Photocell Control Card (PCC). Typically 2 #18 twisted pair wires are used for runs of up to 200 ft from Blue Box LTD. Longer distances may require the use of shielded wires and/or heavier guage conductors .

| Photocell Type | Description | Wire Color | Wire Gauge | Termination | Required Accessories |
|---------------------|--|------------|------------|--------------------------------|----------------------------|
| PCELL 3WI TZ | 3 wire local indoor photocell | Blue | #18 AWG | Any one of the 4 analog inputs | Direct to the control card |
| | | Green | | Ground | |
| | | Red | | 24 volt | |
| PCELL 2WI/PCELL 2WO | 2 wire global indoor/outdoor photocell | Blue | #18 AWG | Analog input | PCC1/PCC3 |
| | | Red | | 8 volt | |

GLOBAL PHOTOCELL (PCELL 2WI/PCELL 2WO) / PHOTOCELL CARDS (PCC1, PCC3)

The PCC1 one input for a single photocell. It is not generally used for indoor photocells since it does not have a digital enable/disable feature.

The PCC3 cards accepts three photocells which may be enabled or disabled over the bus. For switching relay panels the PCC1 or PCC3 act like light level controlled switches and may turn ON/OFF specific relays.

When used for dimming control, the reported readings from the photocell are used in the scene programming to control the loads.

Sensitivity adjustment is available at the control card per input.

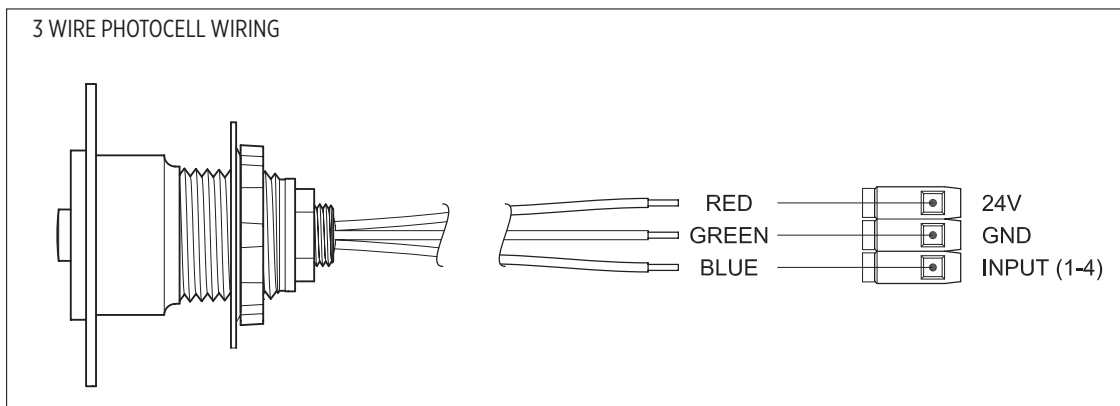

PHOTOCELL PLACEMENT - OPEN LOOP

The photocell reads the level of the ambient light outside the room, coming in through a skylight or a window. It assumes that the relationship between the brightness of the light entering the area and the brightness of the area is relatively constant. This proves to be true in practice and makes for easier setting of the control curves.

Make sure the photocell can see an area that represents the brightness to be measured. Do not place where it can see direct sunlight. Make sure there is no contribution from the lights being dimmed.

PHOTOCELL PLACEMENT - CLOSED LOOP

The photocell reads the level of the ambient light made up of both the light being dimmed and the contribution from a window or a skylight.

Make sure the photocell can see an area that represents the brightness to be measured. Do not place where it can see direct sunlight. Make sure the contribution from the lights being dimmed is approximately equal to the contribution from daylight.

BLOCKING OFF OVERLY BRIGHT AREAS

A direct light source can overwhelm the photocell, impairing its functionality. In this case, use the clip on shields to protect the photocell from the light source.

NOTES FOR ADDRESSING GLOBAL PHOTOCCELL CARDS

Only 10 Photocell Cards (PCC) may be used for providing global readings on the bus. Since each of those cards can be a PCC3 this means that up to 30 photocells may be global. This count does not include the photocells that plug directly into the Blue Box LTD control card. The number is limited in order to ensure sufficient speed of update, (once per second with 30 photocells and quicker with less) while not clogging up the bus with data.

The Photocell Cards must have sequential addresses in order to be accessed. If an additional Photocell Card is used for some other feature such as an outdoor photocell, it can be placed at a non sequential address that has a higher number. Refer to the Blue Box LTD Programming Guide for setup details.



WARRANTY

Lighting Control & Design Inc. warrants each new unit for 36 months from date of shipment to be free of defects in material and workmanship under conditions of normal use and specified ambient temperature when installed and operated under LC&D's product specifications and in accordance with the National Electrical Code. LC&D shall at its option, repair or replace any defective unit which in its opinion, has not been improperly installed, wired, insulated, used or maintained, provided however that LC&D shall not be required to remove, install or reinstall any defective unit and provided that LC&D is properly notified of said defect within the aforementioned warranty period. Additionally, LC&D shall also replace any relay that fails within the first 36 months under a "no questions asked" exchange policy. The foregoing warranty and optional remedies are exclusive and, except for the foregoing warranties THERE ARE NO OTHER WARRANTIES OF MERCHANTABILITY OR OF ANY OTHER TYPE. In no event shall LC&D or any other seller be liable for consequential or special damages, nor for any repair work, undertaken without its prior written consent, nor shall LC&D's liability on any claim for damages arising out of or connected with the manufacture, sale, installation, delivery or use of said unit ever exceed the price paid therefore.

BLUE BOX™ LTD

PARTS REPLACEMENT GUIDE

WARNINGS

1. All servicing should be performed by qualified service personnel.
2. “WARNING, Battery may explode if mistreated. Do not recharge, disassemble or dispose of in fire.”
3. “CAUTION - This equipment provides more than one power supply output source. To reduce the risk of electric shock disconnect both normal and emergency sources within this unit before servicing any equipment connected to this unit”
4. When using electrical equipment, basic safety precautions should always be followed including the following:
 - a. READ AND FOLLOW ALL SAFETY INSTRUCTIONS.
 - b. Do not use outdoors.
 - c. Do not mount near gas or electric heaters.
 - d. Equipment should be mounted in locations and at heights where it will not readily be subjected to tampering by unauthorized personnel.
 - e. The use of accessory equipment not recommended by the manufacturer may cause an unsafe condition.
 - f. Do not use this equipment for other than intended use.
 - g. SAVE THESE INSTRUCTIONS.
5. If any Emergency Circuits are fed or controlled from this panel, it must be located electrically where fed from a UPS, generator, or other guaranteed source of power during emergency and power outage situations.

BLUE BOX LTD REPLACEMENT PARTS OVERVIEW

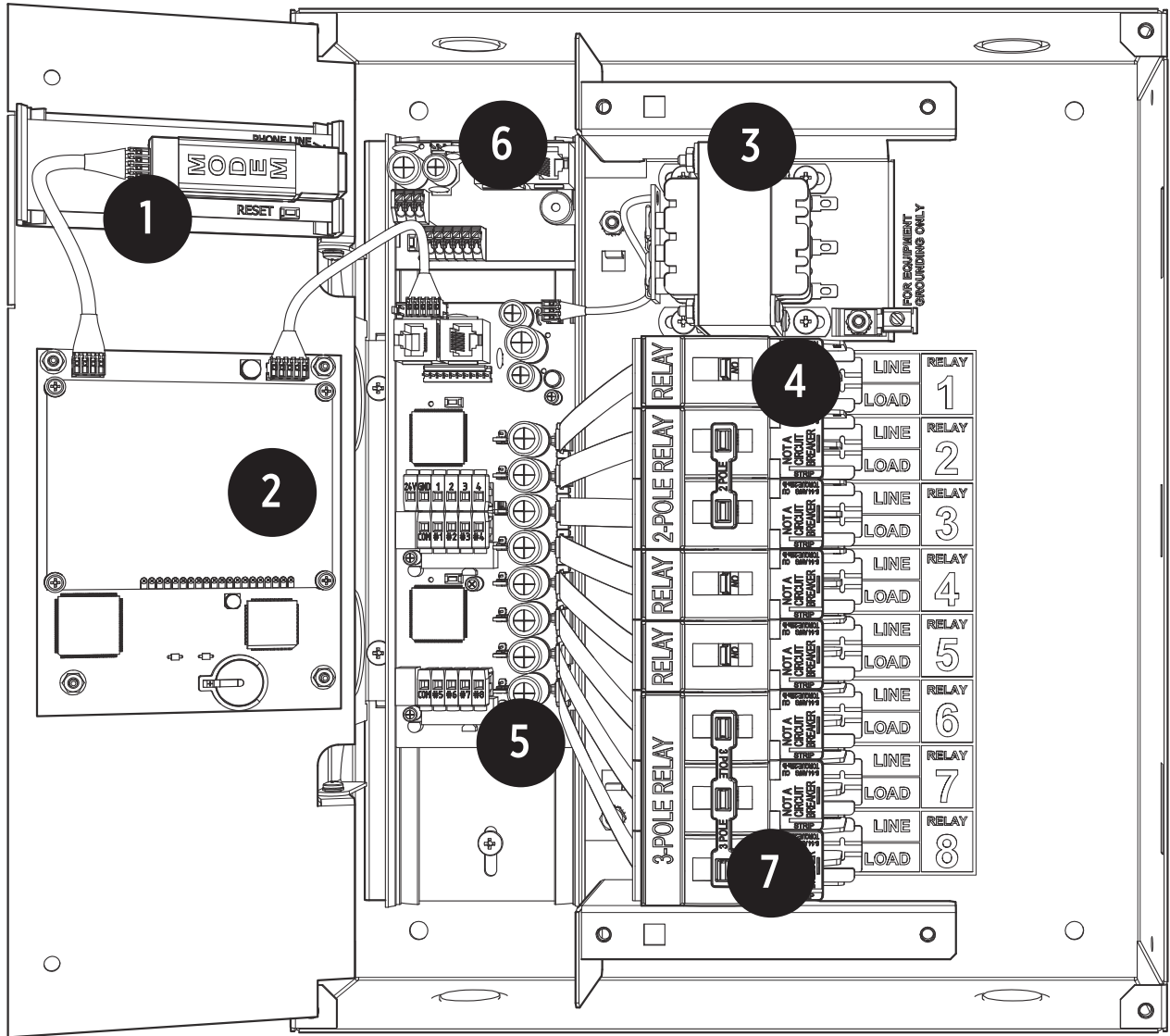

REPLACEMENT PARTS ORDERING INFORMATION

1. Blue Box LTD Modem - GR1400 MOD
2. Digital Time Clock - GR1400 LTD DTC
3. Transformer - LCDACC DV 56VA
4. DIN Relay - LCDACC FCR40
5. Blue Box LTD Control Cards - LCDACC 1404DM PCBA, LCDACC 1408DM PCBA and LCDACC 1416DM PCBA
6. Blue Box LTD Digilink - GR1400 LTD DIGILINK D6 (6 inputs) and GR1400 LTD DIGILINK D14 (14 inputs)
7. DIN Relay Clips - LCDACC FCR CNVTKIT

PARTS REPLACEMENT INSTRUCTIONS

RELAY REPLACEMENT AND INSTALLATION

To remove a relay:

1. For master panels: Unscrew and open the hinged display-panel door to expose the low-voltage section.
2. De-energize all breakers feeding relays and disconnect the AC power from transformer to the control card.
3. Disconnect the low voltage jumper that connects the relay to the control card.
4. Unscrew and open the dead-front cover to expose the high-voltage section.
5. Disconnect line and load wires from the terminals on the relay to be replaced.
6. Apply a flat head screw driver to the white tab at the bottom of the relay, high voltage side. Pull the tab away from the relay until it “clicks” un-securing the relay from the DIN rail.
7. Multiple connections and clips may need to be removed for multi-pole relays.

To install a relay:

1. Align the relay on the DIN rail. Push in the white tab on the high voltage side until it “clicks”.
2. Reconnect the low voltage jumper between the relay and the relay driver pins on the control card.
3. Reconnect Line and Load conductors to the connection lugs.

WARNING: Tighten down relay terminal screws per torque spec, located in the high voltage compartment. Failure to do so may result in loose contact, electrical shock, overheating and/or permanent component damage!

4. Re-apply low voltage and high voltage dead fronts and screw down.
5. After the part replacement installation is complete, return the part using the prepaid UPS return label to factory.

[Note: If the part is not returned within a 30-day period, your account will be automatically billed for the part.]

To test the replacement relay:

1. Switch the breakers powering all the relays and the transformer back ON.
2. Navigate on the DTC to USER MENU > MANUAL OVERRIDE and TAB or SCROLL to the correct LCP and Load (relay) and press ENTER to cycle the relay on and off 3 or 4 times, allowing a second or two between cycles. Visually confirm that the relay is functioning properly.

DI CARD REPLACEMENT AND INSTALLATION

To remove a DI Card:

1. Note the programming and the address of the existing DI Card. Refer to the Panel Schedule located in the master panel or use the READ

ADDRESS function (Refer to Blue Box LTD Hardware Troubleshooting manual).

2. Disconnect the RJ45 jumper cable from the DI card (leave it connected to the control card).
3. Label and remove all low voltage conductors for contact closure devices from the input/output terminals by pushing down the release button next to the wire.
4. Remove the DI card out of the plastic track by inserting a flat-blade screw driver into the slot on the side of the card and twisting to release the board.

To install a DI card:

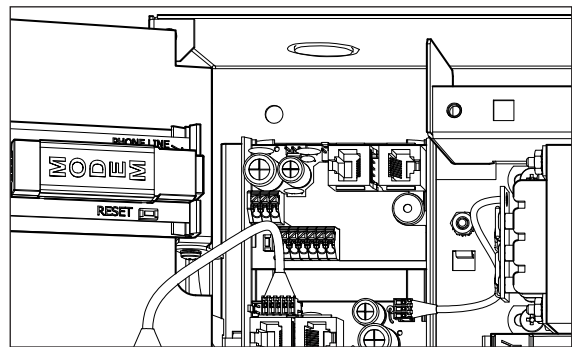

1. Snap the new DI card into the upper slot of the plastic track .
2. Reconnect all low voltage conductors for contact closure devices to the input/output terminals.
3. Re-connect the RJ45 jumper cable to the DI card.
4. Proceed to addressing the DI card.
5. After the part replacement installation is complete, return the part using the prepaid UPS return label to factory.

[Note: If the part is not returned within a 30-day period, your account will be automatically billed for the part.]

To address the replacement DI card

1. Navigate to the AUTO-ADDRESSING screen: USER MENU> SETUP MENU> RESTRICTED (PASSCODE: 900001) > ADDRESSING-BUS SCAN > AUTO ADDRESSING.
2. SCROLL UP until the address of the previous DI is displayed.
3. Press the address button on the DI card.
4. If the DI “takes” the address, the display will increment by one (e.g. from “3” to “4”).

To verify the bus recognizes the replacement DI card:

1. Navigate to SCAN BY SERIAL NUMBER screen: USER MENU > SETUP MENU > RESTRICTED (PASSCODE 900001) > ADDRESSING – BUS SCAN> BUS DIAGNOSTICS > MORE DIAGNOSTICS > DEVICE MANAGEMENT > SCAN BY SERIAL#
2. ENTER to begin a system scan.
3. The screen should show no collisions or “0” addressed devices. If collisions are present, refer to the “Scan by Serial Number” section of

the Blue Box LTD System Diagnostics Tools manual.

4. Reconnect all low voltage conductors for contact closure devices to the low voltage input/output terminals.
5. Program the new DI card according to previous card programming. Refer to Panel Schedule located in the master panel.

CONTROL CARD REPLACEMENT AND INSTALLATION

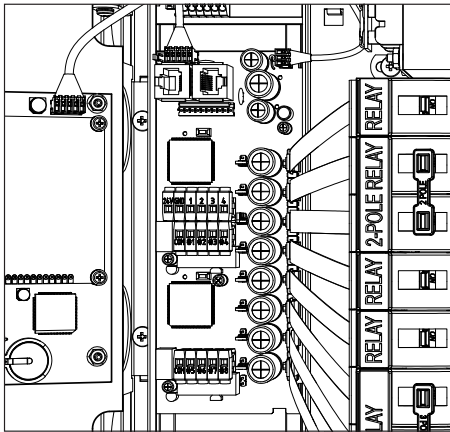

To remove a control card

1. Disconnect the AC input from the transformer to the control card.
2. Once the panel is de-powered, disconnect all cables connected to the control card.
3. For the GR1416 LTD panel: separate the primary from the secondary control card before removing from the snap track by sliding the boards apart to disengage the connector. Insert a flat blade screw driver into the slot between the two boards and twist to separate the boards. Remove one card a time.
4. Remove card by inserting a flat blade screw driver into the slots on the right side of each control card and twist to snap out of the plastic track.

To install a control card

WARNING: Misalignment of pins with mating connector can cause permanent board damage. See Blue Box LTD Hardware Troubleshooting before removing or replacing the LTD control card.

1. Snap the control card into the upper groove of the plastic track by inserting the left side of the card first, then pressing down on the right side. For the GR1416 LTD panel: insert the two cards separately before joining the 20 position connectors. Slide both control cards together.
2. Re-connect all cables and conductors to the control card.
3. Power up the Blue Box LTD panel, look for the blinking “on line” LEDs on the control card(s).
4. After the part replacement installation is complete, return the part using the prepaid UPS return label to factory.

[Note: If the part is not returned within a 30-day period, your account will be automatically billed for the part.]

Re-program control card:

Note: Please refer to Blue Box LTD Programming Guide for details.

1. Address device to previous addresses.
2. Add the LCP back into any pre-existing groups that it was programmed into. Any groups which had relays in the replaced LCP(s) will need to be modified to add back the relays from the replaced LCP(s). Relays from other LCPs that are online at the time will automatically appear on the Groups screens.
3. Reprogram the scenes that were previously used.
4. If the onboard contact closures are being used, set the contact closure input modes according to previously used configuration.
5. Set relay properties if changed from factory default programming on the previous board

DTC DISPLAY REPLACEMENT AND INSTALLATION

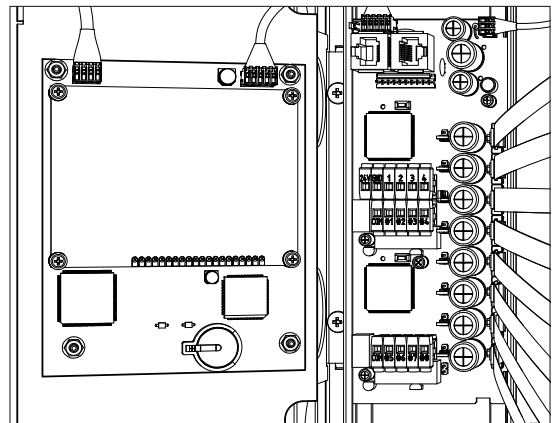

1. Unplug the cable(s) at the back of the DTC.
2. Unscrew the four fasteners on the back of the DTC.
3. Mount the new DTC.
4. Re-connect the cable(s) to the new DTC.
5. After the part replacement installation is complete, return the part using the prepaid UPS return label to factory.

[Note: If the part is not returned within a 30-day period, your account will be automatically billed for the part.]

Re-program DTC:

Note: Please refer to Blue Box LTD Programming Guide for details.

1. Time schedules
2. Reassign groups to time schedules
3. Re-input bus map
4. Set time and date
5. Set location
6. If necessary disable daylight savings time

TRANSFORMER REPLACEMENT AND INSTALLATION

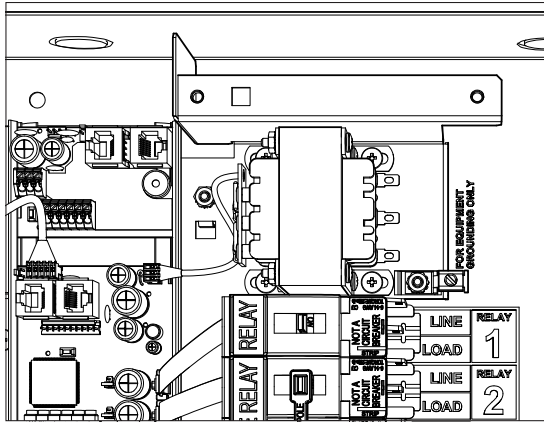

To remove a transformer

1. De-energize the Blue Box LTD by switching off the breaker feeding the power supply (the relays in that panel will close). De-energize any other breakers that may present a hazard during installation.
2. For master panels: Unscrew and open the hinged display-panel door to expose the low-voltage section.
3. Unscrew and open the dead-front cover to expose the high-voltage section.
4. Disconnect the hot and neutral wires from the transformer input leads.
5. Unplug the low voltage power lead that connects the transformer to the control card.
6. Remove the four screws at the base of the transformer.

To install a transformer

1. Mount the new transformer with the four screws.
2. Reconnect the low voltage connectors.
3. Reconnect hot and neutral conductors.
4. Install high-voltage dead-front cover to the panel.
5. Re-energize breakers.
6. Visually inspect that the ONLINE LED on the control card is blinking.
7. If a master panel: verify the DTC is powered up and fasten the low-voltage dead-front cover.
8. After the part replacement installation is complete, return the part using the prepaid UPS return label to factory.

[Note: If the part is not returned within a 30-day period, your account will be automatically billed for the part.]

CHELSEA DIGITAL SWITCH

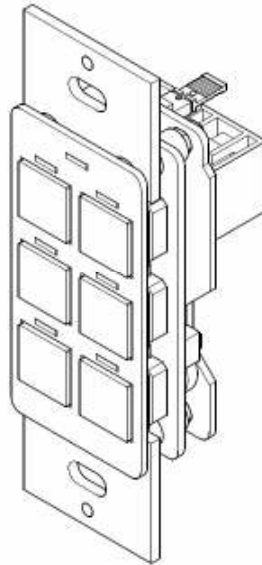

ADVANCED PROGRAMMING GUIDE

CONTENTS

| | |
|---|---------|
| 1. Overview..... | Page 1 |
| 2. Important Programming Notes | Page 2 |
| 3. The Switch Setup Screen (First Screen) | Page 3 |
| a. 7 On = _____ | Page 4 |
| b. 8 On = _____ | Page 5 |
| c. BTN Beep | Page 6 |
| d. Button 1 Address | Page 6 |
| e. 9-14 disable 1-6 | Page 7 |
| f. Debounce | Page 7 |
| 4. The Switch Setup Screen (Second Screen) | Page 9 |
| a. ALL-OFF logic except groups | Page 9 |
| b. LED logic for other buttons | Page 10 |
| 5. The Button Edit Screen | Page 11 |
| a. LED mode | Page 11 |
| b. Toggle mode | Page 12 |
| c. Debounce | Page 12 |
| 6. Common Applications | Page 13 |
| a. How do I disable a particular switch button? | Page 13 |
| b. How do I set a button to give an audible “error” beep when someone presses a disabled button? | Page 14 |
| c. How do I make a switch give an audible alert during a blink warning period? | Page 15 |
| d. How do I set up a room with a partition, so that the switches change their function depending on whether the partition is open or closed? | Page 17 |

Overview

The Chelsea Digital Switch has been updated with several new programmable features. In summary, they are:

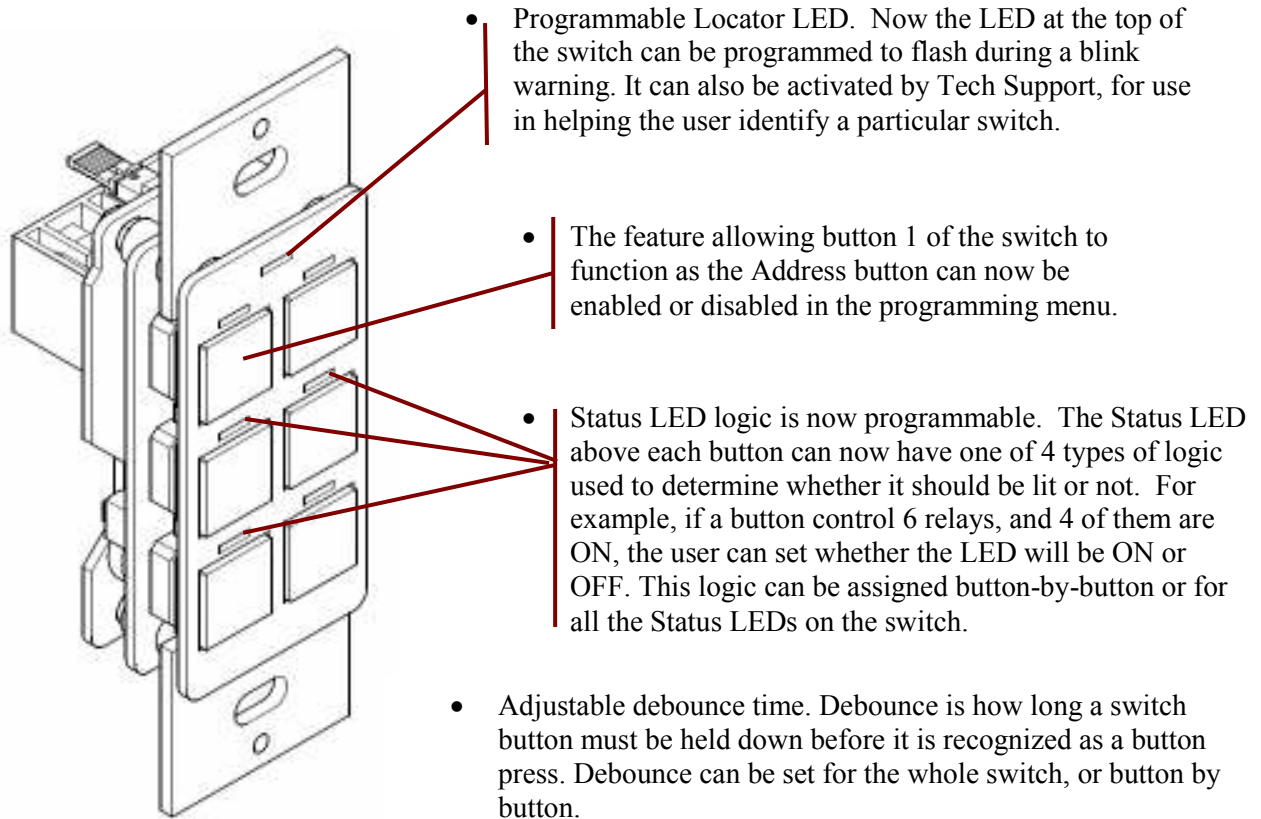

- Audible beep alert which can be used to notify users during a blink warning period before the lights shut off. The beep pattern is programmable and can also be used by Tech Support to help the customer locate a specific switch on the bus.
- Alternate button programming. Chelsea Digital Switches can now have two sets of programming for six buttons, or three sets of programming for three buttons. Each set of programming can be activated by a time schedule, override switch, etc. This feature is useful for setting buttons to function differently at different times of day, or in partitionable rooms where a switch functions differently depending on whether a partition is open or closed.
- Programmable Toggle logic. If a button controls multiple relays, it is important to synchronize them when toggling them all at once. If some of the relays are ON and some are OFF, it is now possible to specify whether the switch syncs them all ON or all OFF when toggling.
- Enabling and disabling individual switch buttons is still an available feature carried over from the previous version of the Chelsea. Enabling and disabling buttons can now be allowed or not allowed for a switch in the programming menu. Additionally, disabled buttons can be set to trigger a rapid series of beeps when pressed, so the user knows that the button has specifically been disabled by programming.

! Important Programming Notes !

To use the advanced features of the new Chelsea Digital Switch, please ensure the following:

- Always set a Chelsea Digital Switch as a “14 Button Switch” in the Panel/Switch Types screen. This is true even if the switch only has 1, 2 or 3 physical buttons. The reason for this is because advanced programming requires setting parameters for buttons 7-14, even though they are “virtual” buttons and not physically present on the switch.
- To access advanced programming functions of the Chelsea Switch, you must have DTC clock version 4.48 or later.
- To use advanced programming functions of the Chelsea Switch, you must be using switch firmware 1.12 or later. The version of firmware a switch has is displayed in the lower left corner of the SETUP screen for that switch.

The Switch Setup Screen (First Screen)

To access the screen, navigate to the switch you want to program, highlight the word **SETUP** and press **ENTER**.

USER MENU → PROGRAM SWITCH → SWITCH# → SETUP

Select "SETUP"
and press
ENTER

```
SELECT BTN SWI ID#7
SETUP      PAGE 1-3
B1:      BUTTON 1
B2:      BUTTON 2
B3:      BUTTON 3
B4:      BUTTON 4
B5:      BUTTON 5
B6:      BUTTON 6
```

The Switch Setup Screen has a number of parameters which can be set as shown below.

7 ON = _____
8 ON = _____
Btn Beep
Button 1 Address
9-14 Disables 1-6
Debounce

```
SWITCH ID#7 SETUP
7 ON= Beep
8 ON= Normal
Btn Beep: Off
Button 1 Address: Y
9-14 Disables 1-6: N
Debounce: By Button
Ver 1.12
```

More

Table 1.1

| 7 ON = _____ | |
|---|--|
| <p>This field determines what happens when the LED status light associated with Button 7 is turned ON.</p> <p style="text-align: center;">Generally if the button is set to ON MODE and the relay it controls is ON, the LED will turn ON as well. This also applies to the opposite mode: if the button is set to OFF MODE and the relay it controls is OFF, the LED will also generally turn ON (the only exceptions are if the logic of the Status LEDs are changed as described later in this guide).</p> <p>Note that there is no physical Button 7 or physical Status LED for Button 7 on a Chelsea Digital Switch. So Buttons 7-14 are virtual buttons used for programming purposes only, and the associated Status LEDs are also just virtual placeholders that are turned on and off. Usually, virtual Buttons 7 and 8 will be set to operate a spare relay or an empty relay position rather than a relay with a connected load.</p> | |
| Possible Values | Result |
| Normal (default value) | None. Setting this value to “Normal” in a Chelsea Digital Switch means that nothing will happen when the virtual LED associated with Button 7 is turned ON. |
| BTS 1-6 < 9 - 14 | When the virtual LED associated with Button 7 is ON, the programming for buttons 1-6 will be replaced with the programming for buttons 9-14. When the LED is OFF, buttons 1-6 will revert to their original programming. |
| BTS 1-3 < 9 - 11 | When the virtual LED associated with Button 7 is ON, the programming for buttons 1-3 will be replaced with the programming for buttons 9-11. When the relay is OFF, buttons 1-3 will revert to their original programming. |
| BEEP | When the virtual LED associated with Button 7 is ON, the switch will make a beeping sound. Highlighting the word BEEP and pressing ENTER will allow you to set the beep pattern. |
| Locator | When the virtual LED associated with Button 7 is ON, the switch’s Locator LED will flash. Highlighting the word Locator and pressing ENTER will allow you to set the flash pattern. |
| Disable 1-6 | When the virtual LED associated with Button 7 is ON, buttons 1-6 will be disabled. |
| Disable 1-14 | For a Chelsea Switch, this has the same effect as “Disable 1-6”. However, when programming a Digilink, it allows all Digilink inputs (1-14) to be disabled. |
| Beep + Locator | When the virtual LED associated with Button 7 is ON, the switch will make a beeping sound and the Locator LED will flash. Highlighting the words Beep + Locator and pressing ENTER will allow you to set the beep and flash pattern. |

Table 1.2

| 8 ON = _____ | |
|--|---|
| <p>This field determines what happens when the LED status light associated with Button 8 is turned ON.</p> <p>The operation of this field is almost identical in operation to the “7 ON = ___”. The parameters are the same as those given in Table 1.1 above with a few exceptions noted below.</p> <p>In general, the BTS 1-6 < 9 – 14, BEEP, Locator, and Disable 1-6 functions assigned to “7 ON = ___” take priority over their “8 ON = ___” counterparts.</p> <p>For example: If a switch is set to “7 ON = BEEP” and “8 ON = BEEP” and both virtual LEDs are ON, the switch will have the BEEP pattern of “7 ON = BEEP” not the pattern of “8ON = BEEP”.</p> <p>If a switch is set to “7 ON = LOCATOR” and “8 ON = BEEP” and both virtual LEDs are ON, the switch will blink the Locator LED and also beep.</p> | |
| Possible Values | Result |
| Normal (default value) | None. Setting this value to “Normal” in a Chelsea Digital Switch means that nothing will happen when the virtual LED associated with Button 8 is turned ON. |
| BTS 1-6 < 9 – 14 BEEP Locator Disable 1-6 | These settings operate in the same way as they are described in table 1.1 |
| BTS 1-3 < 12-14 | When the virtual LED associated with Button 8 is ON, the programming for buttons 1-3 will be replaced with the programming for buttons 12-14. When the relay is OFF, buttons 1-3 will revert to their original programming. |
| Disable 9-14 | Used only in Digilinks to disable higher numbered inputs. |

** “8 ON = ___” Does not have a “Beep + Locator” option.

Important Note On Using “7 ON = 1-3 ← 9-11” and “8 ON = 1-3 ← 12-14” in tandem:

If the switch has the settings “7 ON = 1-3 ← 9-11” and “8 ON = 1-3 ← 12-14”, and the relays operated by Button 7 and Button 8 are BOTH ON, then buttons 1-3 will execute both sets of programming (9-11 and 12-14) at the same time. Please ensure that there is no conflicting programming as the behavior of the loads controlled will become unpredictable. An example of conflicting programming is Button 9 turning ON a relay and Button 12 turning OFF a relay.

Table 1.3

| BTN Beep | |
|---|---|
| This field determines when the switch's buttons will cause a beeping sound. | |
| Possible Values | Result |
| OFF | There will never be a beeping sound when a button is pressed. Note that any beep alerts set to take place using the "7 On = _____" or "8 On = _____" fields will still be executed. Setting "BTN Beep" to OFF only effects normal button presses, not special alerts. |
| PUSH only | The buttons on the switch will beep when pressed. (Note that operating the same load(s) from another location will not cause the beep) There will be no rapid series of beeps when a disabled button is pressed, it will simply cause the standard single beep. |
| Disable | Buttons will not normally beep when pressed; however, if the user presses a disabled button, the switch will give a rapid series of beeps to alert them that the button will not operate as expected because it has been disabled. |
| Push + Disa. | Buttons on the switch will give a standard single beep when pressed. If the user presses a button that has been disabled, the switch will alert them with a rapid series of beeps. |

Table 1.4

| Button 1 Address | |
|--|--|
| This field determines whether Button 1 on the switch will act as the Address Button (meaning that the user can set and read the address by pushing Button 1 instead of having to press the Address Button on the back of the switch). This is generally set to "Y" (Yes) except on Digilinks, which are always set to "N". | |
| Possible Values | Result |
| Y | Yes, Button 1 will function as the Address Button |
| N | No, Button 1 will not function as the Address Button |

Table 1.5

| 9-14 disable 1-6 | |
|--|---|
| <p>Determines whether “virtual” buttons 9-14 can be used to disable buttons 1-6 on the physical switch. For example, if virtual Button 9 is set to turn on relay X, then any time relay X is ON, the physical Button 1 will be disabled. If relay X is OFF, then Button 1 will function normally.</p> <p>The same correspondence exists between virtual Button 10 and physical Button 2, virtual Button 11 and physical Button 3, etc.</p> | |
| Possible Values | Result |
| Y | <p>Yes, virtual Buttons 9-14 will enable and disable physical Buttons 1-6. This is the normal, default setting. However, there are times when you should not use this functionality as described below.</p> |
| N | <p>No, virtual Buttons 9-14 will NOT enable and disable physical Buttons 1-6. You should use this option in the following circumstances:</p> <ul style="list-style-type: none"> • If you have set up alternate button programming sets (e.g. you have set “7 ON = BTS 1-6 < 9 – 14” as described earlier in this section). • If you are already using other button disable settings, such as “7 On = Disable 1-14” described earlier in this section. • If you are programming a Digilink, which uses any of the inputs between 9 and 14. |

Table 1.6

| Debounce | |
|--|--|
| <p>This field sets how long the user must hold down a switch button before the system recognizes the button press. If the button is released before the full duration of the debounce time, the press is ignored and no programming is executed.</p> | |
| Possible Values | Result |
| By Button | <p>This value means that the Debounce will be set individually for each individual Button in the Button’s “Edit” menu. There will be no overall setting for all the buttons on the switch.</p> |

| | |
|---|--|
| Selectable value between 0.05 sec and 5.00 sec. | These are global values that apply to all of the switch's buttons. Whatever value is selected will be how long the user must hold down the button before its programming is activated. For example, setting the value to 2.00 sec means that when the user first presses a button on the switch, nothing will happen. However, if the user continues holding down the button for at least 2 full seconds, the button will then operate the relays it was set to control. The default setting is 0.05 sec. Debounce affects button beeping the same way it affects programming. |
|---|--|

Important Note on Debounce:

Use debounce carefully since a long debounce time can make it seem like a switch is not working. If a switch does not appear to function, always check for a debounce setting before assuming that the switch is bad.

MORE

To go to the second page of switch setup options, highlight the field "MORE" and press ENTER.

The Switch Setup Screen (Second Screen)

The Switch Setup Screen has additional parameters shown on a second page in the DTC screen. Along with the Debounce option on the first screen, these parameters are global in that they override any local LED logic set in the EDIT menu and apply to all buttons on a switch. These parameters can be set as shown below:

LED Logic for buttons in ALL-OFF mode, except buttons controlling MOMENTARY OFF groups.

LED logic for buttons in all other modes.

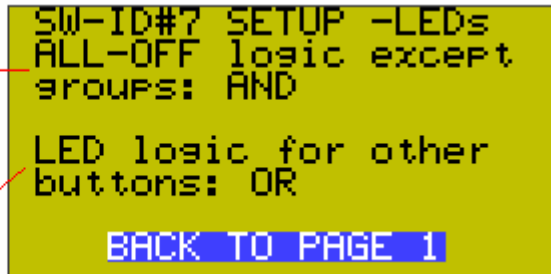

Table 2.1

| ALL-OFF logic except groups | |
|---|---|
| Sets the logic which determines if the Status LED over each of the switch's buttons should be on or off. This field applies only to buttons programmed in OFF MODE. If a button only turns lights OFF, then it is customary to have the Status LED be lit when all of the controlled relays are in the OFF position. However, there are some applications when different logic is needed. | |
| Possible Values | Result |
| AND | The Status LED on a button set to OFF MODE will light up only if ALL the controlled relays are OFF. (This is also called "True" switch logic and is usually used for buttons in OFF MODE or MIX MODE). |
| OR | The Status LED on a button set to OFF MODE will light up if one OR more of the controlled relays are OFF. |
| OR-INVERT | The Status LED on a button set to OFF MODE will light up only if NONE the controlled relays are OFF (i.e. they are all ON) |
| AND-INVERT | The Status LED on a button set to OFF MODE will light up if ONE OR MORE of the controlled relays are ON. Therefore, if they are all OFF, the LED light will not be lit, but if at least one relay is ON, the LED will be lit. |

Table 2.2

| LED logic for other buttons | |
|--|--|
| Sets the logic which determines if the Status LED over each of the switch's buttons should be on or off. This field applies to buttons in TOGGLE MODE, ON MODE, MAINTAIN, MIX MODE (all other settings except OFF MODE). | |
| Possible Values | Result |
| AND | The Status LED on a button will light up only if ALL the controlled relays are ON. In MIX MODE the LED will be lit only if ALL the controlled relays are in the state (ON or OFF) the button was programmed to set them to. (This is also called "True" switch logic. It is usually used for MIX MODE or OFF MODE buttons.) |
| OR | The Status LED on a button will light up if ONE OR MORE of the controlled relays are ON. In MIX MODE the LED will be lit if ONE OR MORE of the controlled relays are in the state (ON or OFF) the button was programmed to set them to. (Usually this logic is used for buttons that are set to something other than MIX MODE or OFF MODE). |
| OR-INVERT | The Status LED on a button will light up only if NONE of the controlled relays are ON (i.e., they are all OFF). In MIX MODE the LED will be lit only if NONE of the controlled relays are in the state (ON or OFF) the button was programmed to set them to (they must all be in the opposite state from what the button was assigned to set them to). |
| AND-INVERT | The Status LED on a button will light up only if ONE OR MORE of the controlled relays are OFF. In MIX MODE the LED will be lit only if ONE OR MORE of the controlled relays are in the opposite state from what the button was programmed to set them to. |

| BACK TO PAGE 1 |
|---|
| To go back to the first page of switch setup options, highlight the field "BACK TO PAGE 1" and press ENTER. |

The Button Edit Screen

To access the Button EDIT screen, navigate to the switch button you want to program, highlight the word EDIT and press ENTER. These parameters are local, meaning that they apply to each individual button only, not the entire switch.

USER MENU → PROGRAM SWITCH → SWITCH# → BUTTON# → EDIT

Select "EDIT"
and press
ENTER

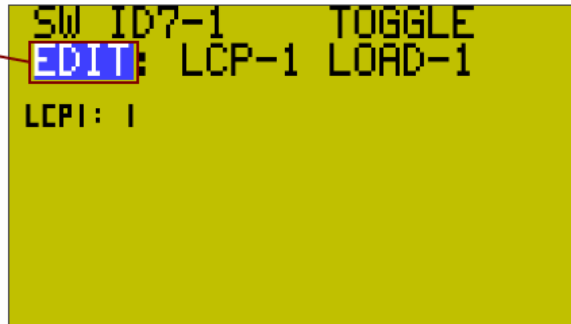

The Button Edit Screen has the parameters which can be set as shown below.

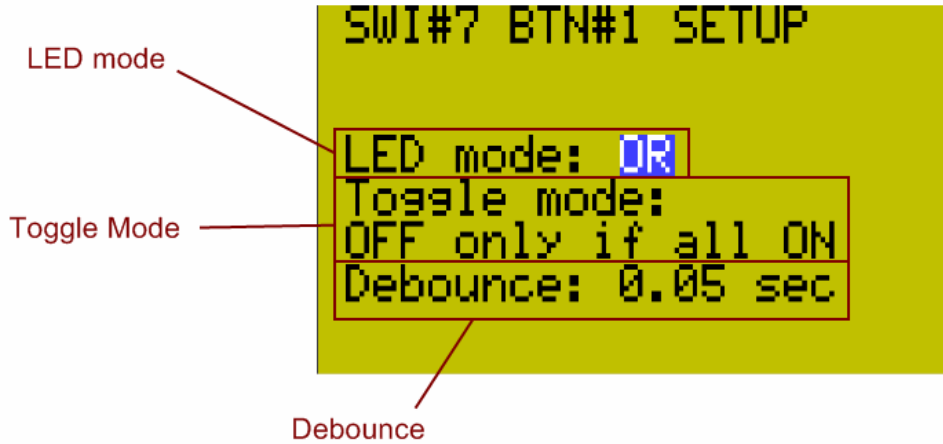

Table 3.1

| LED mode |
|--|
| <p>Sets the logic which determines if the Status LED over the button should be on or off.</p> <p>The operation of this field is identical in operation to the SETUP second screen LED logic except these settings apply only to a single button because they are local settings. The parameters are the same as those given in Table 2.1, if OFF MODE is used, or Table 2.2 above for all other modes.</p> |

Table 3.2

| Toggle mode | |
|---|---|
| <p>Sets how the button synchronizes multiple relays when toggling. For example, if a switch button is toggling relay X, relay Y and relay Z, the user can decide what happens when relay Y is ON and relays X and Z are OFF. The least desirable behavior is to have the relays just flip states so that no matter how the TOGGLE button is pressed either, relay Y is OFF and relays X and Z are ON, or relay Y is ON and relays X and Z are OFF. This would make it impossible to get all the lights ON or OFF at the same time. Therefore, one of the two types of logic below is used to sync the relays that are being toggled by a switch button.</p> | |
| Possible Values | Result |
| OFF if any load ON | If any ONE OR MORE of the relays controlled by the switch button are ON, then pressing the toggle button will turn ALL relays OFF. |
| OFF only if all ON | If the relays are out of sync, the toggle button will first bring them all ON. Then, once they are all ON, pressing the toggle button again will turn them all OFF. |

Table 3.3

| Debounce |
|---|
| <p>Works in the same manner as SETUP menu Debounce except it applies to individual buttons, has no “By Button” option, and only appears on screen if SETUP menu Debounce is set as “By Button”.</p> |

Important Note on Debounce:
Use debounce carefully since a long debounce time can make it seem like a switch is not working. If a switch does not appear to function, always check for a debounce setting before assuming that the switch is bad.

Common Applications

Question:

How do I disable a particular switch button (for example, button 3)?

Answer:

1. Go to the Program Switch screen and select the switch you want to disable the button for. For physical Button 3, you would use the virtual Button 11 to enable and disable it. (See table 4.1 below)

| Button Enable / Disable Relationships | |
|---------------------------------------|---------------------------------------|
| This virtual button: | Disables this physical button: |
| 9 | 1 |
| 10 | 2 |
| 11 | 3 |
| 12 | 4 |
| 13 | 5 |
| 14 | 6 |

2. Select Button 11 on the Program Switch Screen. Assign a spare relay or empty relay position to this button and make sure it is set to ON MODE.
3. Back on the Program Switch screen, again select the switch you want to program and then go to the “SETUP” field and press ENTER.
4. Ensure that the option “**9-14 disable 1-6**” is set to “**Y**” (for Yes). See table 1.5 earlier in this guide for details.
5. Now, when you turn the relay you selected in step 2 above ON, Button 3 will be disabled and not function. When you turn the relay OFF, Button 3 will function again. Remember, you can turn this relay ON and OFF using schedules, groups, other switches, or even photocells that pass a certain light level!

Question:

How do I set a button to give an audible “error” beep when someone presses a disabled button?

Answer:

It can be very frustrating or confusing to a user when they press a button that usually turns certain lights on and off, only to find that nothing is happening. Sometimes, this happens when a switch button has been programmed to be disabled, but the user has no way of knowing. Therefore, it is helpful to set up the switch to make an “error” beep if the user presses a disabled button. To do this, follow the steps below:

1. Go to the Program Switch screen and select the switch you want to set up the error beep for.
2. Highlight the “SETUP” field and press ENTER
3. Set the option labeled “**BTN Beep**” to “**Disable**”. This causes the switch to emit a rapid series of beeps if a user presses a button that has been disabled. See Table 1.3 earlier in this guide for details.
4. If you want the switch to make a standard beep whenever an enabled button is pressed, and a rapid series of beeps when a disabled button is pressed, set the “**BTN Beep**” option to “**Push + Disa.**” See Table 1.3 earlier in this guide for more details.

Question:

How do I make a switch give an audible alert during a blink warning period?

Answer:

It is a fairly common request to have users notified a few minutes before the lights turn off, so they have an opportunity to override the off-sweep. Instead of having the lights flash, or a separate horn installed, the new switch can be set to generate a beeping alert pattern as a warning that the lights will be shutting off shortly. To do this:

1. First, create a Maintain+Blink Group containing the relays that are going to be turned on and off with the schedule. You can use any Timer and Blink Warning settings you wish; typical values are a 2 hour Timer and a 5 minute Blink Warning. Make sure that you include one spare relay or empty relay position in the group. This will be the "Horn Driver relay"
2. Once you have created the Maintain + Blink Group above, go to the Relay Properties Screen for the individual relay you set as the "Horn Driver relay". Change the Horn Driver Mode parameter to "Y" (for Yes). Set the Horn One parameter to the length of time you want the audible alert to last. Then exit out of the screen.
3. (Optional) You will probably want to set the "No Blink" option to "Y" (for Yes) for all the relays in the Group to prevent them from flashing OFF and then ON again when the Blink Warning starts. Sometimes, the flash is desirable, but since there is going to be an audible alert, the lights blinking will most likely not be necessary.
4. Now create a new MOMENTARY ON Group that contains all the same relays as your group from step 1 above, including the Horn Driver Relay.
5. Assign the MOMENTARY ON Group to the switch and button that you want to behave as an override, to turn the lights on or keep them on at the end of the schedule / blink warning period.
6. For the same switch, go to the PROGRAM SWITCH screen, select the switch, highlight the "SETUP" field and press ENTER.
7. On the switch SETUP screen, set either the "7 ON =" or "8 ON =" field to the option "BEEP". (See Tables 1.1 and 1.2 earlier in this guide for full details).
8. In the Program Switch Screen, set either Button 7 or Button 8 (depending on which you selected in the previous step) to ON MODE, and have it associated with the relay you set earlier as the Horn Driver Relay.

9. That's it. Now, at the end of the schedule, the switch will start beeping to signal that the lights will be shutting off shortly. If the user presses the override button on the switch, the beep alert will stop, and the lights will stay on for an additional 2 hours (or whatever duration the Timer was set to in the Maintain+Blink Group). At the end of this 2 hour period, the switch will start beeping again to signify the lights will be shutting off, at which point the user can override the shutoff again and start the cycle over again, or simply let the lights go off.

** The procedure just described can also be used to make the Locator LED blink. Just replace "BEEP" in step 7 with "Locator".

Question:

How do I set up a room with a partition, so that the switches change their function depending on whether the partition is open or closed?

Answer:

Let's take a scenario where a room has a switch on the north wall, a switch on the south wall, and a partition that can separate the room into a north half and a south half.

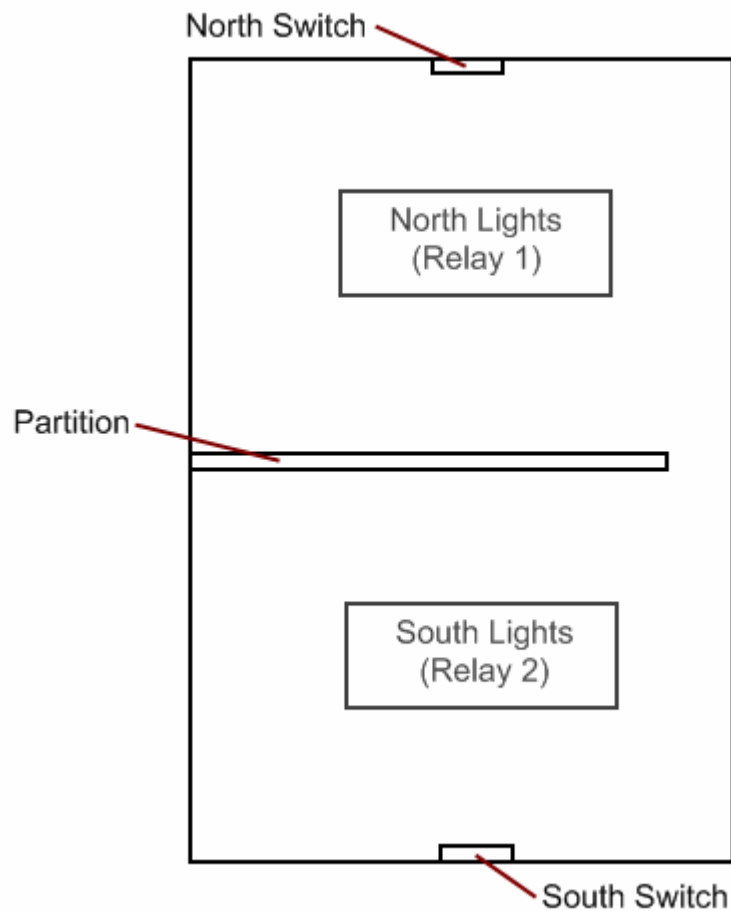

Each switch has an ON button and an OFF button. When the partition is open, the switches control both sets of lights in the room (North *and* South lights, i.e. Relay 1 *and* Relay 2). When the partition is closed, the South Switch turns on and off the South Lights (Relay 2) *only*, and the North Switch turns on and off the North Lights (Relay 1) *only*.

Here are the steps to accomplish this:

1. For the North Switch, program Button 1 to ON MODE for Relay 1 and Relay 2. Program Button 2 to OFF MODE for Relay 1 and Relay 2.
2. While still in the Program Switch screen for the North Switch, set Button 9 to ON MODE for Relay 1 *only*. Program Button 10 to OFF MODE for Relay 1 *only*.
3. Program Button 7 to ON MODE for a spare relay or empty relay position (Relay X).
4. Now go to the North Switch “SETUP” screen and set the parameter “7 ON =” to the option “BTS 1-6 < 9 – 14”. (See Table 1.1 for full details).
5. Now, for the South Switch, program Button 1 to ON MODE for Relay 1 and Relay 2. Program Button 2 to OFF MODE for Relay 1 and Relay 2.
6. While still in the Program Switch screen for the South Switch, set Button 9 to ON MODE for Relay 2 *only*. Program Button 10 to OFF MODE for Relay 2 *only*.
7. Program Button 7 to ON MODE for the same spare or empty relay position you used in step 3 above (Relay X).
8. Now go to the South Switch “SETUP” screen and set the parameter “7 ON =” to the option “BTS 1-6 < 9 – 14”. (See Table 1.1 for full details).
9. Set another switch button, or a Digilink with an input coming from a partition sensor, to turn ON Relay X when the partition is CLOSED and turn OFF Relay X when the partition is OPEN.
10. That’s it. When the partition is closed or separate switch button is pressed, each switch will only control the lights in their half of the room. When the partition is open, each switch controls ALL of the lights in the room.

ADDITIONAL BLUE BOX RESOURCES

(hyperlinks provided below)

Software Guides

[Unity GX2™ Customer Submission Guide](#)

[Unity 2.2 Software](#)

[Unity VClock Software](#)

[BACnet Configurator](#)