



Blue Box LT Operation, Programming and Maintenance Manual

Project Name:
Project Location:
Acuity Agency:
Order #:
PO #:
Project ID:
Date:

Controls Tech Support:

1-800-535-2465 - option 1: nLight; option 2: SSI; option 3: Fresco; option 4: Synergy; option 5: LC&D/Bluebox; option 6 ROAM
To preschedule a call with tech support (providing a 4 hour business lead time) go to the following link: <http://www.acuitybrands.com/resources/schedule-support-request>

Additional Technical Literature:

<https://www.acuitybrands.com/products/controls/blue-box>

Table of Contents

<u>Blue Box LT O&M</u>	3
<u>Chelsea Digital Switch Programming Guide</u>	151
<u>Additional Resources (Product specific user guides, Programming documents, etc)</u>	171



THE BLUE BOX™ LT

OPERATION & MAINTENANCE MANUAL

LCDBOX M03Sept08



Lighting Control & Design
905 Allen Ave, Glendale CA 91201
Tel: 800-345-4448 • www.lightingcontrols.com

TABLE OF CONTENTS

OVERVIEW5

GRI404LT / GRI408LT Drawings & Details.7

 Relay Overview10

GRI416 LT Drawings & Details.11

 Introduction to The Blue Box LT™ Series.15

 The Blue Box LT™ vs. Lighting Contactors16

 Build Your System in 3 Steps17

 Most Popular Accessories20

 Applications.22-23

MAINTENANCE & TROUBLESHOOTING25

Making Up Cat. 5 Cable With RJ45 Connectors27

 How To Make Proper Crimps35

Adding a New Device39

Parts Replacement & Installation Guide.47

Hardware Troubleshooting59

Troubleshooting with An Oscilloscope.63

Programming67

 DTC Clock Navigation Basics69

 Manual Control of Relays70

 Programming Switches or DI Inputs.71

 Time Schedules.73

 Programming a Blue Box LT Photocell.76

 To Add a Holiday List to a Schedule77

 More Data on Scheduled Events78

 Group Types80

 Programming Groups.81

 Additional Groups Parameters.82

 Group FAQs83

 Other System / Set up Programming.86

 Daylight Saving Time.86

 Keyboard Lock Code.87

LCDBO&M01Sept08

TABLE OF CONTENTS (Continued)

Time Schedule Programming Examples.....	88
Exercise #1- Contact Closure Device Controlling 4 Relays.....	88
Exercise #2 - Contact Closure Device Controlling 10 Relays.....	88
Exercise #3 - Time Schedules with Override Switches.....	88
Exercise #4 - Retail Store.....	89
System Diagnostics Tools.....	91
System Start Up & Cabling Guide.....	95
Frequently Asked Questions.....	103
APPENDIX.....	111
Installation Guide GRI404 LT & GRI408 LT.....	113
Installation Guide GRI416.....	117
Chelsea Installation Guide.....	121
PCO Installation (Out Door Photocell) Installation Guide.....	123
Digital Input Card Installation Guide (For Contact Closures).....	125
Occupant Sensors (Hook-Up and Programming).....	129
Novitas® Brand Occupant Sensors.....	131
Sensor Switch® Brand Occupant Sensors.....	132
Wattstopper® Brand Occupant Sensors.....	133
Hubbell® Brand Occupant Sensors.....	134
LC&D® Brand Occupant Sensors.....	135
Clock /Programming Navigation Tree.....	137-139
Technical Glossary.....	141-143

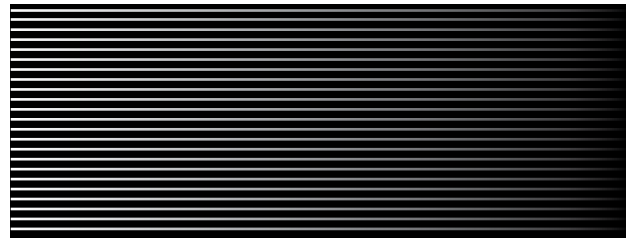
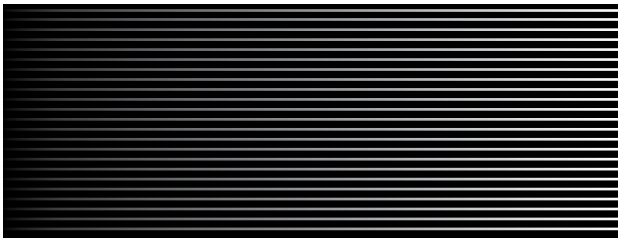

THE BLUE BOX™ LT

OVERVIEW

LCD880035sept08



Lighting Control & Design
905 Allen Ave, Glendale CA 91201
Tel: 800-345-4448 • www.lightingcontrols.com

TABLE OF CONTENTS

GRI404LT / GRI408LT Drawings & Details	7
Relay Overview	10
GRI416LT Drawings & Details	11
Introduction to The Blue Box™ LT Series	15
The Blue Box™ LT VS. Lighting Contactors	16
Build Your System In 3 Steps	17
3 Enclosure Sizes	18
2 Panel Configurations	19
Master Relay Panel	19
Slave Relay Panel	19
Most Popular Accessories	20
Applications	22
Small Parking Lot (Single Control Panel)	22
Retail Stores (With 6 Override Zones)	22
Warehouse (Multiple Control Panels)	23
Blue Box Technical Support	24

GR1404LT / GR1408LT DRAWINGS & DETAILS

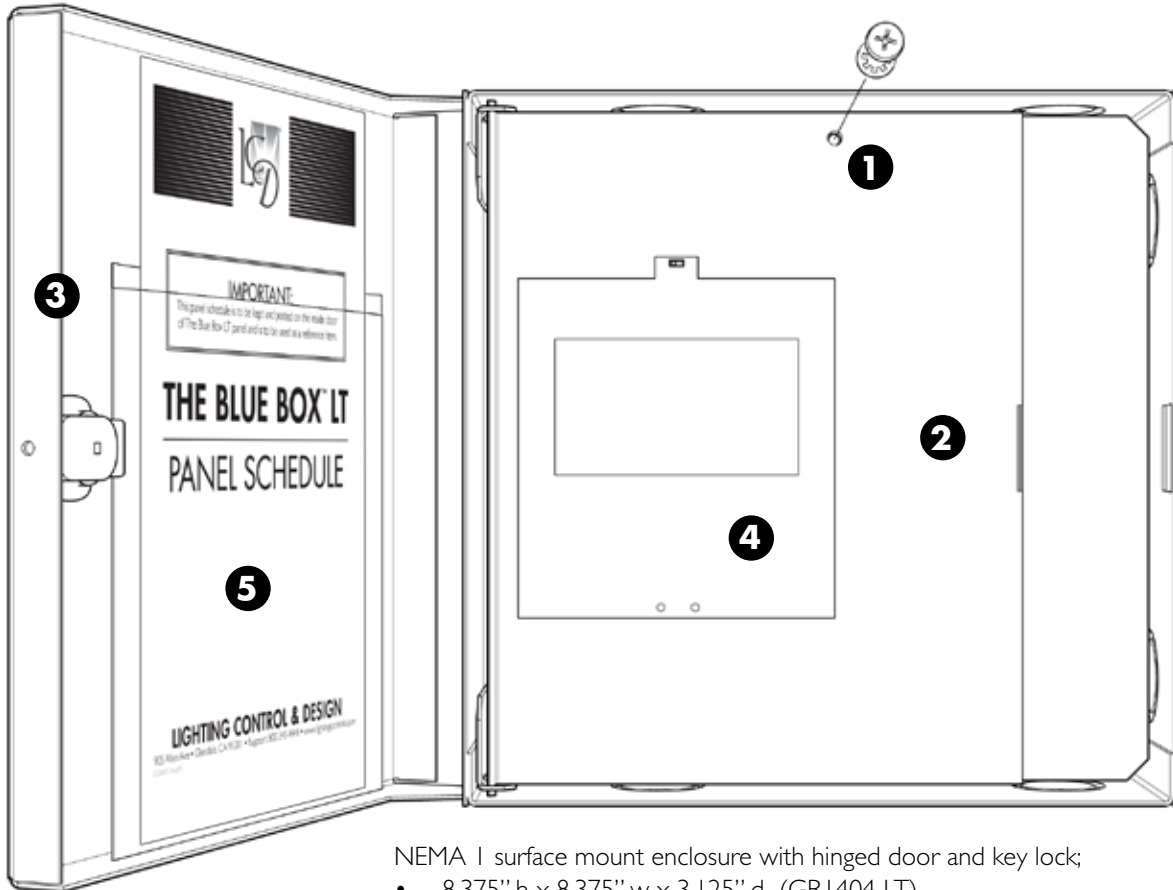

NEMA 1 surface mount enclosure with hinged door and key lock;

- 8.375" h x 8.375" w x 3.125" d (GR1404 LT)
- 13.5" h x 8.5" w x 3.125" d (GR1408 LT)

GR1404/08 LT (FRONT DOOR OPEN)

- | | |
|---|--|
| <ol style="list-style-type: none"> 1. Screw fastener secures white door (Master only). 2. White door provides a barrier between Control Interface and High Voltage connections beneath (Master only). 3. Hinged locking blue door. 4. DTC Clock / Display & Programming Interface: 32-channel, 365-day astronomical clock with Scroll and Tab to access control features for entire system (Master only). 5. Door pocket contains the following documenta- | <p>tion: Refer to the Blue Box LT Installation Guide for more information on these documents.</p> <ol style="list-style-type: none"> a) Panel Schedule b) (optional) DI Card schedule. c) If this is a Master panel, the System Device Schedule on the back of the Panel Schedule should also be filled-out. It lists out all of the digital lighting controls devices, where they are and what they do. (see System Start-Up Guide for more information. |
|---|--|

LCD880035sept08

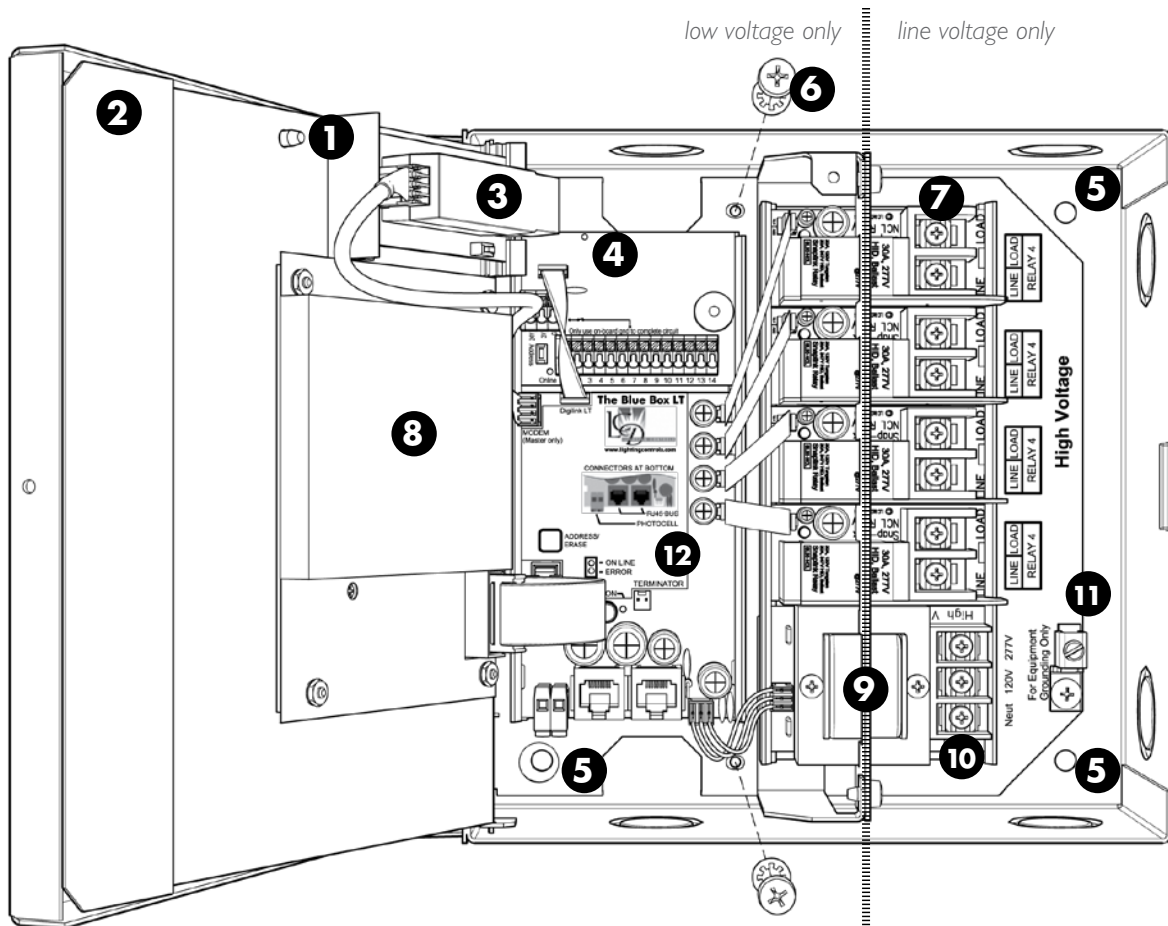

GR1404/08 LT (WHITE DOOR OPEN)

1. Screw fastener secures hinged Control Panel Door (Master only).
2. White door provides barrier between human interface and line voltage connections beneath (Master only).
3. Optional Modem. Free factory dial-up programming.
4. Optional DI contact closure interface card.
5. $\text{\O}1/4$ " mounting holes at 4 places.
6. Optional: Unfasten two screws to remove chassis assembly from enclosure providing full access to mounting holes if required.
7. SnapLink™ relays, Normally-Closed (NC). Status LED is ON when relay is OFF.
8. DTC Clock / Display & Programming Interface: 32-channel, 365-day astronomical clock with Scroll and Tab to access control features for entire system (Master only).
9. Voltage barrier separates line voltage (class 1) & low (class 2) connections.
10. Dual Voltage Power Supply Input: Blue Box LT™ operates on either 120V or 277V.
11. Ground Lug for equipment grounding.
12. Relay Control Card provides interface between control network and relays. The Relay Control Card in the Master panel also holds time schedules and system mapping.

GR1404/08 SLAVE PANEL RELAY CONTROL CARD

GR1404/08 MASTER PANEL RELAY CONTROL CARD

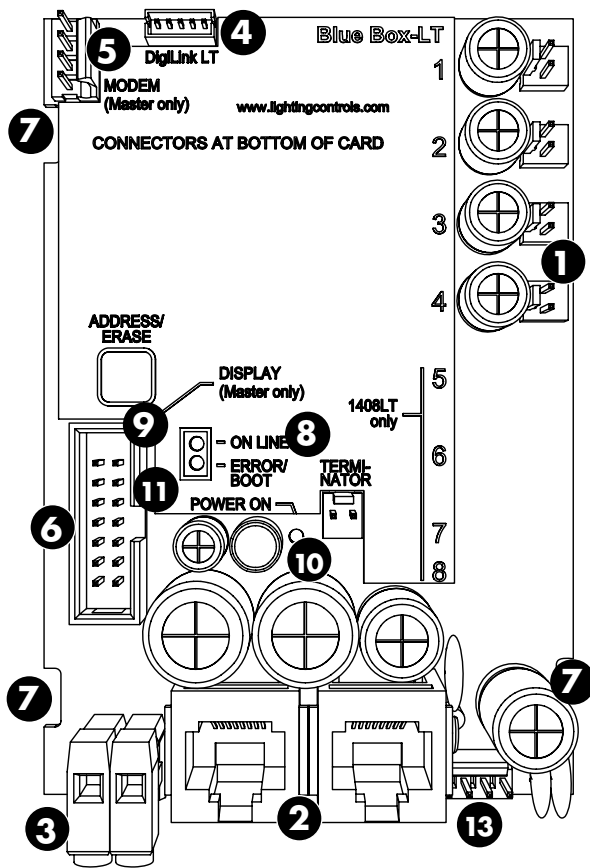
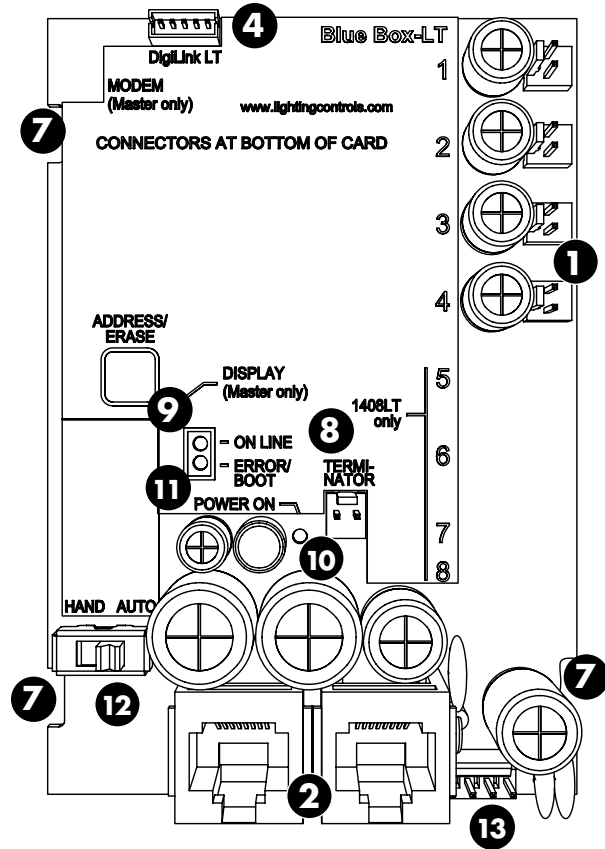

1. Relay Drivers. Opto-isolated to prevent line voltage back-feed and to help prevent RF and EMF noise interference. Relay drivers will close latching relays upon loss of power to the Control Card.
2. RJ45 sockets for digital bus. Digital devices (relay panels, digital switches, etc) connect to this panel using a bus (daisy-chain) topology.
3. Photocell port (master panel only). +V output with a photocell input. Photocells are polarized - follow color code.
4. Power/data connector for DI Card.
5. Power/data connector for modem (master panel).
6. Power/data connector for DTC clock/display (master panel only).
7. Removal slots for control card. Used with a flat blade screw driver to remove the Control Card.
8. Terminator pins. Add terminator here if this is the first or last item on a bus (follow the "System Start-Up & Cabling Guide").
9. Online LED indicates the communications micro-processor is functioning, not that the panel can see the digital bus.
10. Power ON LED indicates the control card is receiving power from the transformer and has successfully converted it to DC.
11. Error/Boot LED. Flashes continuously if system failed to boot.
12. Hand/Auto Switch (slave panel only). In Auto mode, relays will react to schedules and switches. In Hand mode, relays will remain closed.
13. Power input from transformer.

LCD880035Sept08

BLUE BOX LT 1404/1408 INTERNAL SCHEMATIC

1. 3#18 AWG. Supplies power from transformer to relay control card.
2. 14 conductor ribbon cable: carries control signal between DTC and relay control card (master panel only).
3. 2 conductor ribbon cable: carries control signal from smacker strip to relays - one per relay.
4. 5 conductor ribbon cable: carries digital signal from relay control card to (optional) digital input card.
5. 4#22AWG carries RS-232 signal from (optional) modem to relay control card (master panel only).
6. Terminator pins. Add terminator here if this is the first or last item on a bus (follow the "System Start-Up & Cabling Guide").

For more information about external hook-ups, refer to GR 1404 LT Installation Guide.

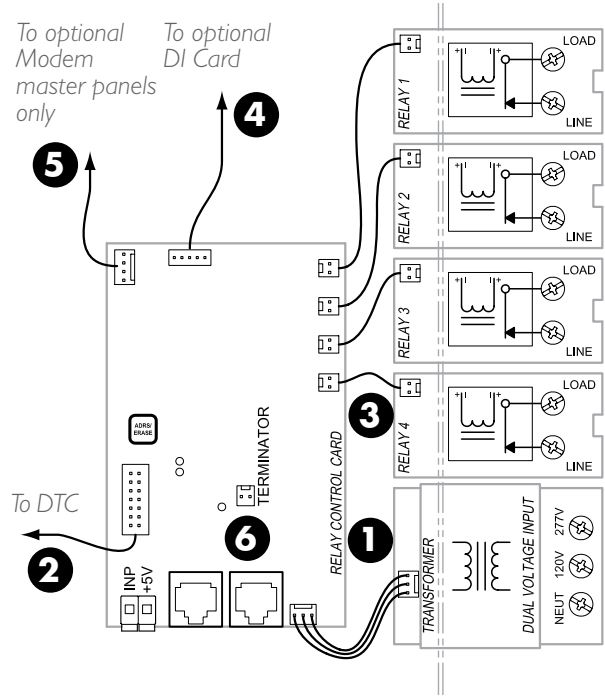

RELAY OVERVIEW

1. Low voltage connector.
2. Status indicator LED.
3. Quick removal slot.
4. High conductivity terminal block.

SnapLink™ Latching Relay: Normally closed latching (NCL), UL listed for 30 amps lighting (ballast, HID) at 277v, 20 amps at 347v and 20 amps Tungsten at 120v, 18,000 amp SCCR at 277v, rated 250,000 on/off cycles, 3 yr. warranty.

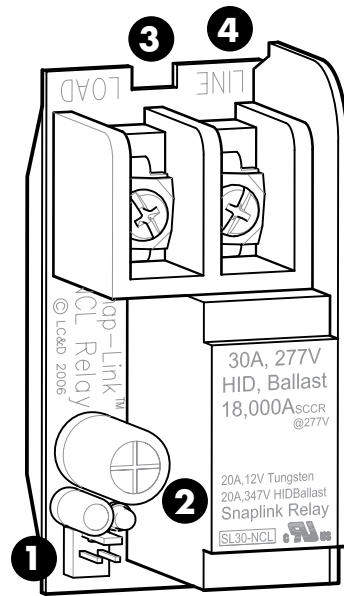

GR1416LT DRAWINGS & DETAILS

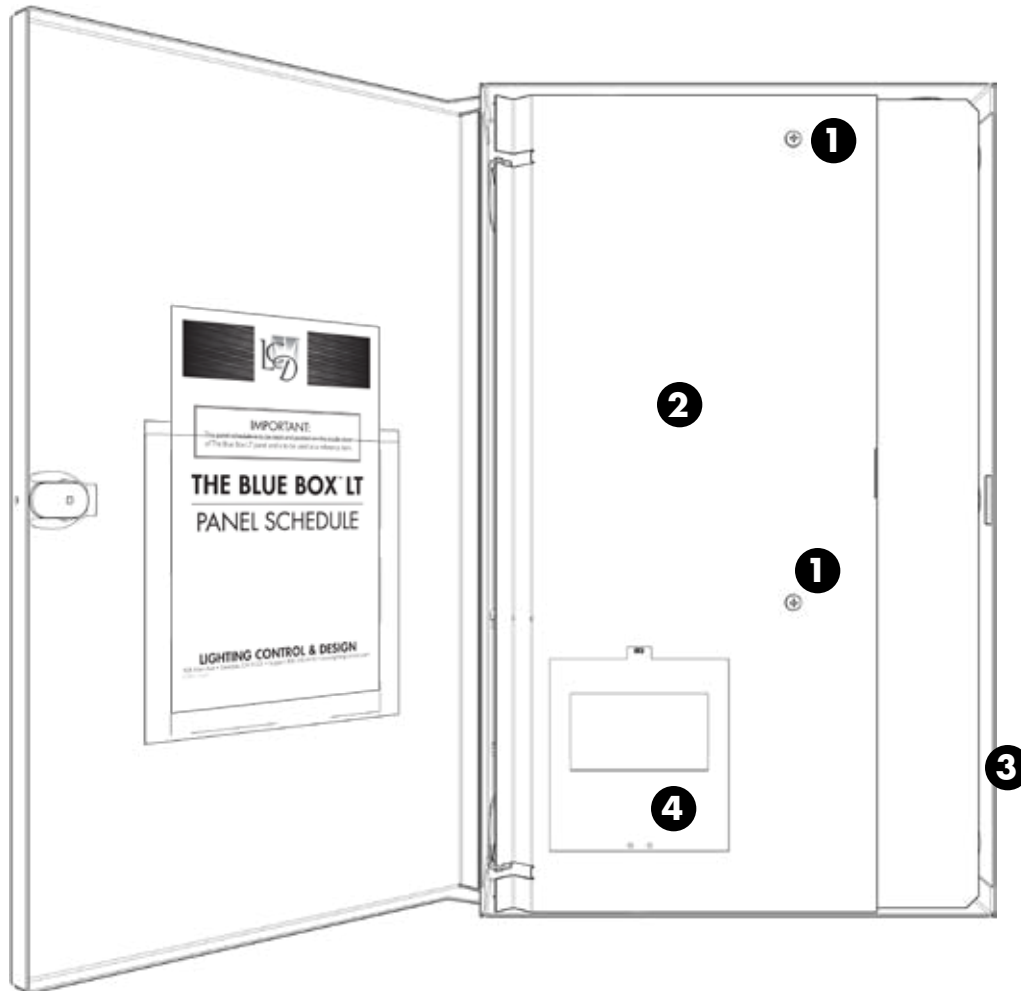

GR1416 LT (FRONT DOOR OPEN)

1. Screw fastener secures hinged Control Panel Door (Master only).
2. Hinged Door Panel provides a barrier between Control Interface and High Voltage connections beneath (Master only).
3. NEMA 1 surface mount enclosure with hinged door and key lock; $\varnothing 1/4$ " mounting holes at 4 places (hardware not included).
4. DTC Clock / Display & Programming Interface: 32-channel, 365-day astronomical clock with Scroll and Tab to access control features for entire system (Master only).

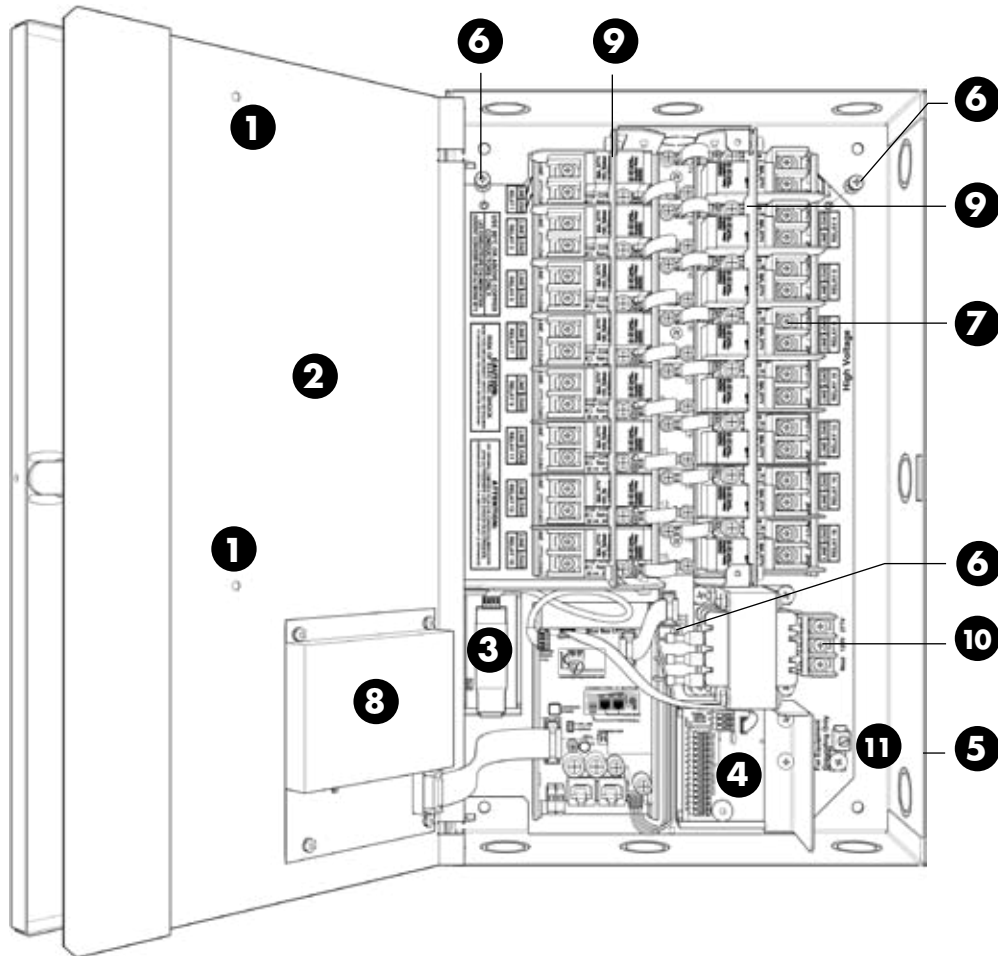

GR1416 LT (WHITE DOOR OPEN)

1. Screw fastener secures hinged Control Panel Door (Master only).
2. Hinged Door Panel provides a barrier between Control Interface and High Voltage connections beneath (Master only).
3. Optional Modem. Free factory dial-up programming.
4. Optional DI contact closure interface card.
5. NEMA 1 surface mount enclosure with hinged door and key lock; Ø1/4" mounting holes at 4 places (hardware not included).
6. Optional: Unfasten three screws to remove chassis assembly from enclosure providing full access to mounting holes if required.
7. SnapLink™ relays, Normally-Closed (NC). Status LED: ON when relay is OFF (NC).
8. DTC Clock / Display & Programming Interface: 32-channel, 365-day astronomical clock with Scroll and Tab to access control features for entire system (Master only).
9. Voltage barrier separates low & line voltage connections.
10. Dual Voltage Input: Blue Box LT™ operates on either 120V or 277V.
11. Ground Lug for equipment grounding.

GR1416 LT SLAVE PANEL RELAY CONTROL CARD

GR1416 LT MASTER PANEL RELAY CONTROL CARD

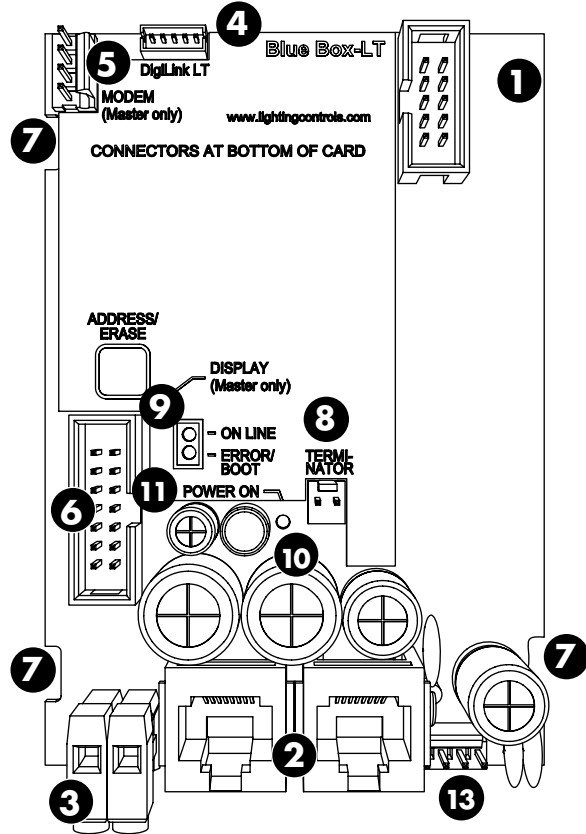
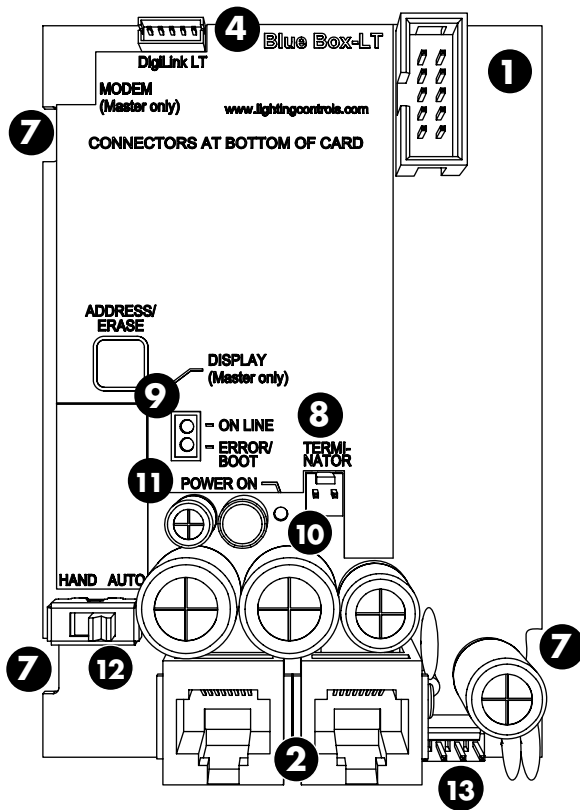

1. Relay Drivers connect to Smacker Strip. Relay drivers will close latching relays upon loss of power to the Control Card.
2. RJ45 sockets for digital bus. Digital devices (relay panels, digital switches, etc) connect to this panel using a bus (daisy-chain) topology.
3. Photocell port (master panel only). +V output with a photocell input. Photocells are polarized - follow color code.
4. Power/data connector for DI Card.
5. Power/data connector for modem (master panel).
6. Power/data connector for DTC clock/display (master panel only).
7. Removal slots for control card. Used with a flat blade screw driver to remove the Control Card.
8. Terminator pins. Add terminator here if this is an end-of-bus panel (per "System Start-Up & Cabling Guide").
9. Online LED indicates the communications micro-processor is functioning, not that the panel can see the digital bus.
10. Power ON LED indicates the control card is receiving power from the transformer and has successfully converted it to DC.
11. Error/Boot LED. Flashing constantly if card cannot boot on start up.
12. Hand/Auto Switch. (slave panel only) In Auto mode, relays will react to schedules and switches. In Hand mode, relays will remain closed.
13. Power input from transformer.

LCD880035sept08

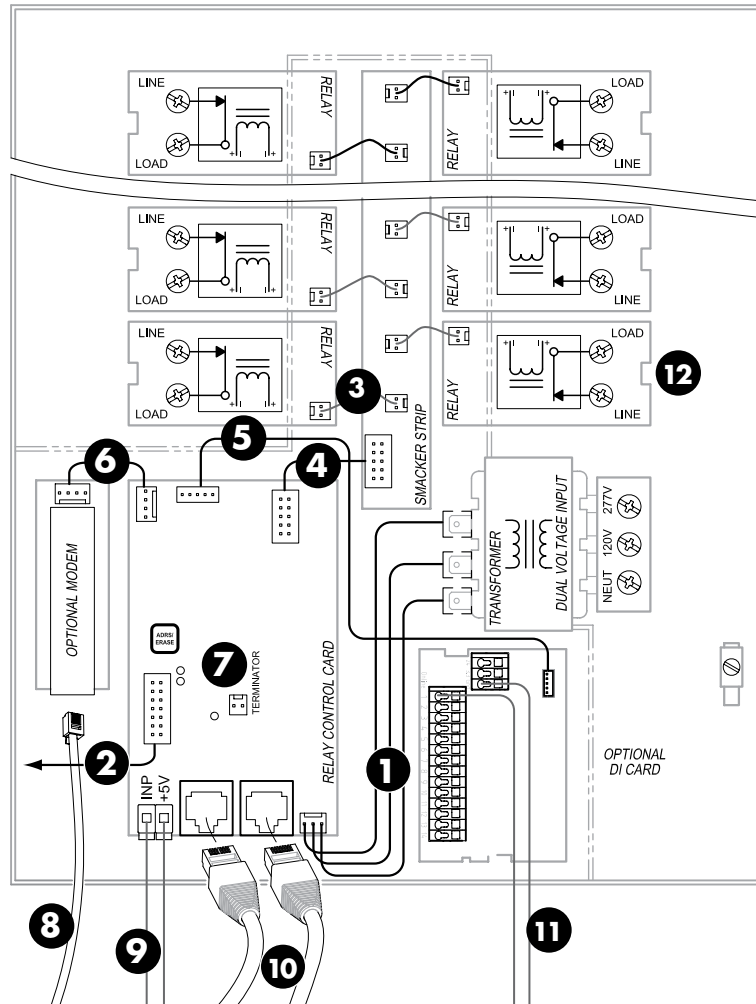

GR1416 LT (DOOR OPEN) INTERNAL SCHEMATIC

1. 3#18 AWG. Supplies power from transformer to relay control card.
2. 14 conductor ribbon cable: carries control signal between DTC and relay control card (master panel only).
3. 2 conductor ribbon cable: carries control signal from smacker strip to relays - one per relay.
4. 10 conductor ribbon cable: carries digital signal from relay control card to smacker strip.
5. 5 conductor ribbon cable: carries digital signal from relay control card to (optional) digital input card.
6. 4#22 AWG carries RS-232 signal from (optional) modem to relay control card (master panel only).

7. Terminator/terminator pins to terminate bus line.
8. 4#24 flat cable from modem to analog phone jack. Always note phone number of modem.
9. 2#18 AWG to Blue Box photocell. Up to 300 feet.
10. Cat. 5 cable with RJ45 connectors links Blue Box to other digital devices (other blue box panels or digital switches).
11. Contact closure inputs & DI card common "GND" + 1 #18 per input.
12. Line and load relay lugs.

For information about cabling for contact closure switches or occupant sensors. Refer to DI Card Installation Guide for options and details.

INTRODUCTION TO THE BLUE BOX™ LT SERIES

The only panel you will ever need for small to medium projects - quicker to install than traditional lighting contactors and much easier to configure. The Blue Box™ LT Series is UL Listed and complies with every energy code in the USA.



LCD880035sept08

THE BLUE BOX™ LT VS. LIGHTING CONTACTORS

SMART RELAY PANEL

The Blue Box™ LT Series is the only panel you will ever need for small to medium projects.

It is quicker to install than traditional lighting contactors as well as more flexible.

With purchase of the optional modem you receive free lifetime dial-up programming support from the factory. Or you can connect remotely using our free software.

The Blue Box™ LT is part of the GR 2400 lighting control system, from LC&D.

Control up to 16 devices.

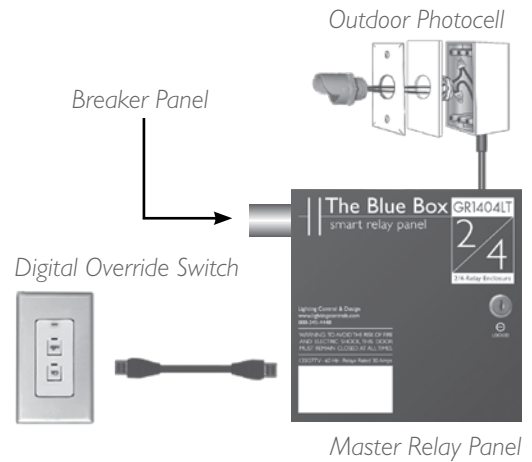

DITCH THE OLD WAY OF DOING THINGS

Traditional lighting contactor panels require an electrical-mechanical assembly specific to the job at hand. This means parts and pieces must be field-assembled and field-programmed.

Any programming or hard-wire changes made to lighting contactor panels require you to go back to the site.



BUILD YOUR SYSTEM IN 3 STEPS

Every system must have a Master Panel which contains the clock and photocell inputs and connections for the optional modem.

STEP 1: MASTER PANEL

How many circuits (relays) do you need to control? (See pgs. 6-7 for enclosure sizes).

Do you need a modem for remote dial-up programming? (See pg. 10, "Modem").

Do you need inputs for occupant sensors, or contact closure switches? (See pg. 10, "Digital Input Card")



Master Relay Panel

Each system needs one master panel. Use one Blue Box™ for each electric room you are controlling lighting circuits in.

STEP 2: SLAVE PANELS

For each additional Blue Box™ LT, how many circuits (relays) do you need to control? (See pgs. 6-7).

For each additional Blue Box™ LT Series, do you need inputs for occupant sensors, or contact closure switches? (See pg. 10, "Digital Input Card")

Up to 16 panels and switches may be controlled on the bus.

Slave Relay Panel



Slave Relay Panel

Master Relay Panel

STEP 3: SWITCHES, OUTDOOR PHOTOCELLS & ACCESSORIES

How many override switches do you need?

How many buttons on each switch? (1 to 6 buttons cost the same).

Will you need a photocell to supplement the DTC astronomical clock? (See pg. 10, "Digital Photocell").

Add other accessories as shown on pages 10-11.

Control up to 16 devices.

Slave Relay Panel

Outdoor Photocell

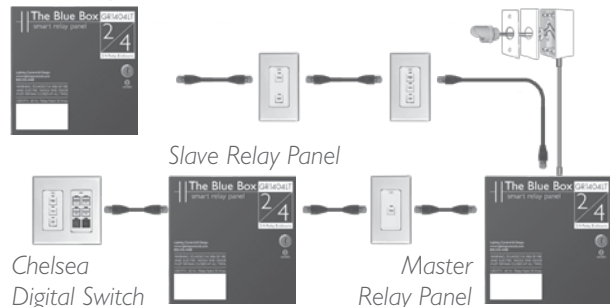

Chelsea Digital Switch

Master Relay Panel

LCD88003Sept108

3 ENCLOSURE SIZES

DESIGNING WITH LIMITED SPACE?

The Blue Box™ LT Series comes pre-assembled and ready for installation in three compact enclosure sizes!

This 100% digital panel can be programmed to operate any lighting scenario and is equipped with a number of accessory devices:

- Easy energy code compliance
- 277V, 30a relays UL Listed for 18,000 SCCR
- Competitively priced against lighting contactors and astronomical or multi-channel clocks
- Digital Switches can turn relays on or off or override time schedules for energy code compliance
- Our simple, intuitive network connects multiple panels and switches using Cat. 5 with RJ45s
- Panels can share the same time schedules and photocell
- Additional relays can be purchased for partially filled panels.
- Hinged locking door

GRI404LT

- Shipped with 2 or 4 relays
- Master or slave configuration
- 8.4"H x 8.4"W x 3"D



GRI408LT

- Shipped with 4 or 8 relays
- Master or slave configuration
- 13.4"H x 8.4"W x 3"D



GRI416LT

- Shipped with 8 or 16 relays
- Master or slave configuration
- 17.1"H x 10.6"W x 3"D



LCD BBO03sept08

2 PANEL CONFIGURATIONS

MASTER RELAY PANEL

Each system needs one master panel equipped with: DTC clock/programmer: Program schedules, switches and photocells for multiple panels.

- 365-day/7-day/astronomical 32 channel clock
- Plain English command prompts
- Non-volatile memory for all programming, 10 year battery back-up for time of day

Photocell Input: One photocell can control any relay in any panel.

Optional modem and Digital Input Card (See pgs. 10-11, "Accessories").

Control up to 16 devices.

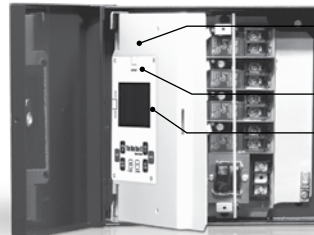

Master Relay Panel

- Modem for remote programming
- Optional Hand/Auto Switch
- DTC clock/programmer
- 32 channel 365 day, 7 day astronomical clock
- Programming access for time schedules, switches, photocell etc.
- Large format screen

SLAVE RELAY PANEL

The slave panel is a fully programmable panel that networks to the DTC, modem, and photocell from the master panel.

No DTC, photocell input, or modem is required in a slave panel, as it uses the master panel.

Option: Digital Input Card allows dry-contact closure switches to control any relay in any panel – wall switches, momentary switches, occupant sensors or any other dry contact switch

(See pgs. 10-11, "Accessories").

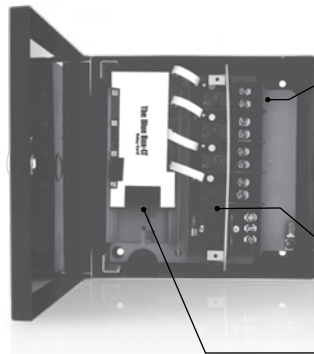

Slave Relay Panel

- Lighting relays:
 - 30A @ 277V Ballast
 - 20A @ 120V Tungsten
 - 20A @ 347V Ballast
 - SCCR 18,000 Amps
- Power supply:
 - 120V/277V
- RJ45s inputs for digital bus

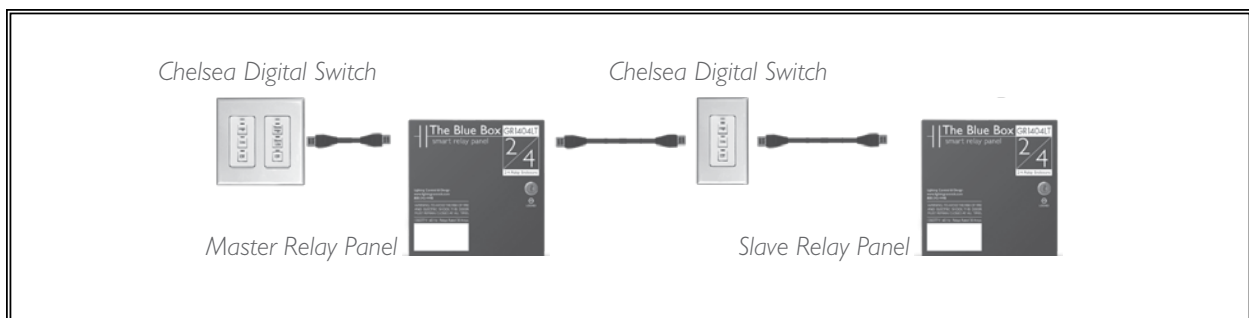

LCD88003Sept08

MOST POPULAR ACCESSORIES

These represent the most popular LC&D accessories. For a complete list of accessories refer to the LC&D Catalog.

Product:	Description:
	<p>Digital Outdoor Photocell (PCO): Connects to the master panel. Recommended for stormy regions (where it may darken early) to supplement the astronomical clock.</p> <p>Product Code: PCO</p>
	<p>Chelsea Digital Switch: With 1, 2, 3, 4 and 6 buttons and free factory engraving. Ideal for override of automatic controls and manual control of lighting. Link with Cat. 5 cable with RJ45s.</p> <p>Product Code: CH-1, 2, 3, 4 and 6</p>
	<p>Modem: Allows you to make changes to the Blue Box™ LT remotely over dial-up. Or call our technical support line and have us do it for you (for free) for the life of the system.</p> <p>Product Code: MOD</p>
	<p>Digital Input Card: Plugs into master or slave panels. For projects that require non-digital switches, including: standard wall switches, center-off momentary switches, occupant sensors, or any dry-contact closure. DI 6 inputs may be enabled / disabled over the bus.</p> <p>Product Code: DI 6 or DI 14</p>
	<p>SnapLink™ Latching Relay: Normally closed latching (NCL), UL listed for 30 amps lighting (ballast, HID) at 277v, 20 amps at 347v and 20 amps Tungsten at 120v, 18,000 amp SCCR at 277v, rated 250,000 on/off cycles, 3 yr. warranty.</p> <p>Product Code: SLNC or SLNO</p>

The accessories below may not be available as a stocking product, but can be ordered.

Product:	Description:
	<p>SwitchBolt: One or two vandal resistance buttons per gang. Switches can be mounted outdoors or almost any location.</p> <p>Product Code: SB-1 or 2</p>
	<p>Link-To PC/Ethernet: Connect multiple computers to the GR 2400 system from any RS232, USB port or an ethernet network connection.</p> <p>Product Code: L2-PC</p>
	<p>Occupant Sensors: A full line of sensors. One sensor can control any relay(s) in any panel(s). Occupant sensors require a Digital Input Card.</p> <p>Product Code: (Contact LC&D factory)</p>
	<p>Digital Rocker Switch: Looks like a regular decora style switch; operates like a 2-button digital switch.</p> <p>Product Code: RS</p>
	<p>Digital Thermostats/T-Link: A single T-Link card can control up to 32 digital thermostats (heat-pump or multi-stage).</p> <p>Product Code: T-LINK (Contact factory for T-STAT ordering.)</p>

LCDBB0035sept08

APPLICATIONS

See how easy it is to design and install the Blue Box™ LT in different applications. We stand behind each of our products with a 3 year warranty.

SMALL PARKING LOT (SINGLE CONTROL PANEL)

Select a master panel with the correct number of relays. The DTC astronomical clock does the rest. Order an outdoor photocell (PCO) as a back up for stormy days (not required for code compliance).

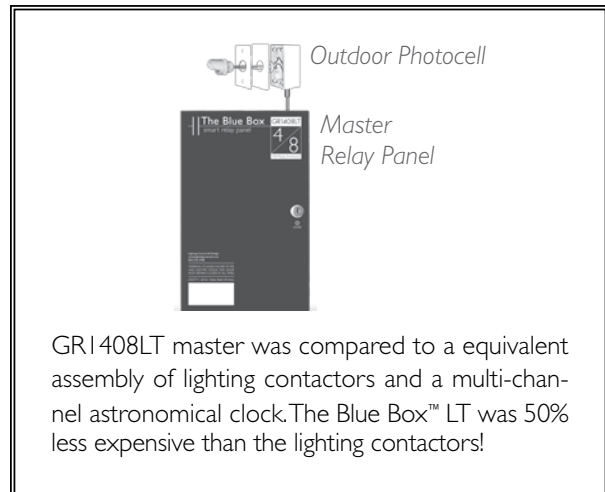

RETAIL STORES (WITH 6 OVERRIDE ZONES)

Separately zone lighting circuits to comply with local codes, and use the DTC clock to schedule the off-sweeps. A multi-button digital switch is the override and manual control, and complies with energy codes.

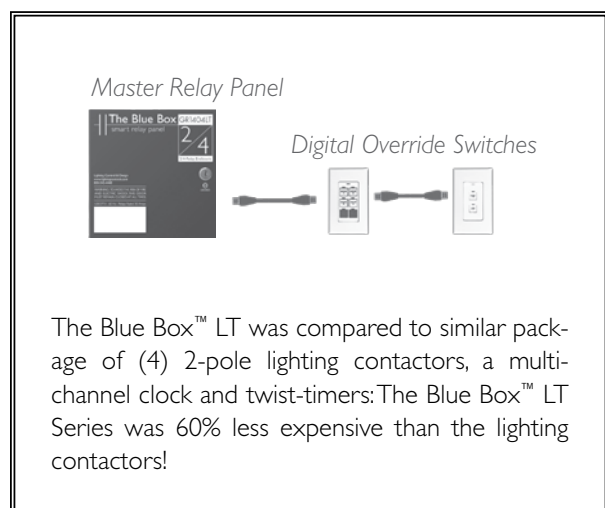

APPLICATIONS (Continued)

How Does the Blue Box™ LT Series Stack-up? In a nationwide survey of Electrical Contractors, the cost to purchase and field-assemble lighting contactor panels was compared to the cost of the Blue Box™ LT Series.

WAREHOUSE (MULTIPLE CONTROL PANELS)

Locate multiple Blue Box™ LT panels and digital switches where you need them and then link them with Cat. 5 cable.

One Blue Box™ LT master (with a Digital Time Clock (DTC) can control relays in multiple slave panels and digital switches (up to 16 digital devices).

Digital switches are used for manual control and after-hours override.

A photocell can be used as back up for outdoor lighting, or even as a simple daylight harvesting system for skylights.

Check your local codes for how large an area each switch can override.

If you are unsure, visit www.lightingcontrols.com for a free code excerpt for your state.

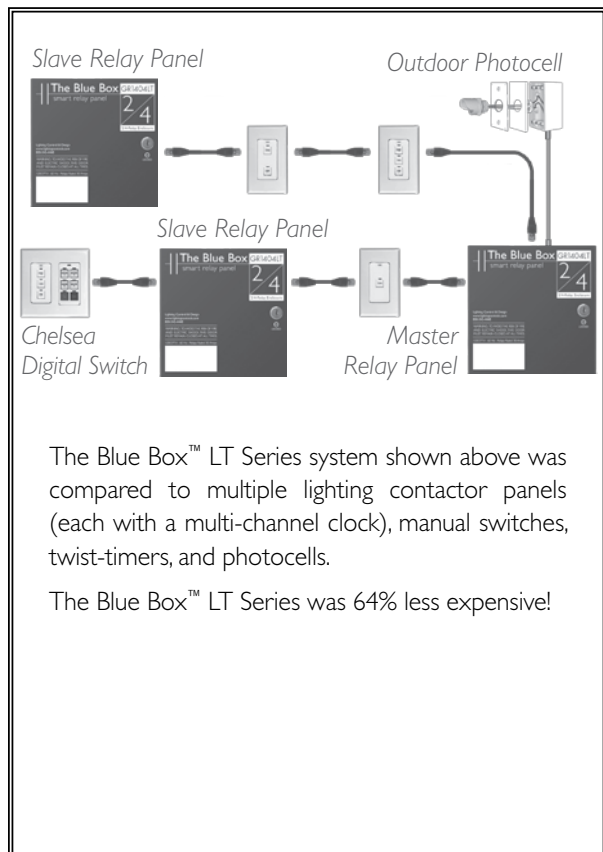

BLUE BOX TECHNICAL SUPPORT

AFTER-MARKET SUPPORT

The Blue Box™ LT Series comes with LC&D's top-notch customer support and, when connected to a phone line, includes free lifetime dial-up programming.

Make changes to the Blue Box™ LT Series remotely (with purchase of a modem) over dial-up. Or call our Technical Support line and have us do it for you (for free) for the life of the system.

DITCH THE OLD WAY OF DOING THINGS

Traditional lighting contactor panels require an electrical-mechanical assembly specific to the job at hand. This means design, parts/pieces and assembly time. Any customer changes require re-wiring and re-assembly.

LIGHTING CONTROL & DESIGN

905 Allen Ave • Glendale, CA 91201 • Support 800-345-4448 • www.lightingcontrols.com

MAINTENANCE & TROUBLESHOOTING

MAINTENANCE & TROUBLESHOOTING

- a) Making Up Cat. 5 with RJ45 Connectors
- b) Adding a New Device
- c) Parts Replacement Guide
- d) Hardware Troubleshooting



THE BLUE BOX™ LT

MAKING UP CAT. 5 CABLE WITH RJ45 CONNECTORS

LCDB874/CAT03Sept08



Lighting Control & Design
905 Allen Ave, Glendale CA 91201
Tel: 800-345-4448 • www.lightingcontrols.com

LIGHTING CONTROLS

TABLE OF CONTENTS

Introduction	29
Ethernet Network	29
The GR 2400 Bus and RS485 Communications Protocol.	30
Cable and Crimping Quality	31
The Importance of a Proper Crimp.	31
Type of Wire	31
The Ideal Scene: Professionally Made Commercial Cables	32
Reasons Why It's Hard to Make Good Crimps on RJ45s	33
Solid Wire is Ductile.	33
The Right Crimping Tool	33
The Right Modular Connector	34
How to Make Proper Crimps	35
Sequence of Actions	35
Miscellaneous Information	37
Cable Kinks	37
Dirty RJ45 Sockets	37
Summary	38
Stable Datums on Crimping Cat. 5.	38

INTRODUCTION

All Lighting Control & Design systems use Cat. 5 cable with RJ45 connectors to network devices. While both our system & Ethernet networks use Cat. 5 cabling, there are huge differences between the two (Note: Cat. 6 is often substituted for Cat. 5. Our system accepts either type of cable.)

ETHERNET NETWORK

Typically Ethernet networks have multiple devices connected to a central point, this design scheme is called a star topology (Figure 1.1 illustrates a multi-level star topology). In this example, the four workstations are connected directly to a switch/hub, which is connected to another star to access either the file server, printer or router.

The hub/switch receives the data sent by the four workstations; upon receipt of the data, the hub/switch checks the data for errors and re-transmits to another switch to access the other devices on the network. The data travels only one section of the cable before it gets cleaned up or repeated and forwarded to another point. Thus any incon-

sistent quality in the Cat. 5 cable or crimp will not severely impact this network's stability. It may slow the data transmission on one leg of the network, but not as to affect the other nodes on the network.

In an Ethernet network, one cable is connected to the switch, workstation, printer, etc. and terminated at a jack socket in the wall (Figure 1.2a and 1.2b). This socket has insulation displacement connections, which do not require crimping. The cable from the wall socket to the device is typically a factory-manufactured cable. These cables use flexible stranded wires and crimps made on pneumatic crimping machines, which exert several hundred pounds of pressure to ensure an excellent crimp.

Figure 1.1 - Typical Ethernet Network Setup
 Ethernet uses Cat. 5 cables, each cable does not exceed 100 meters (330ft).

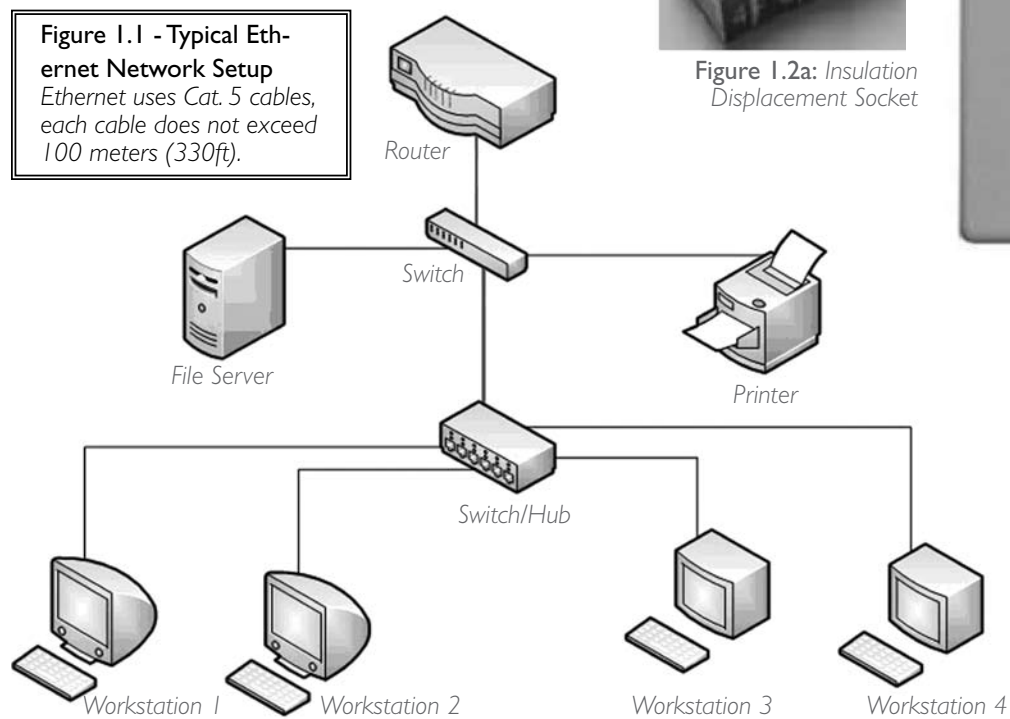

Figure 1.2a: Insulation Displacement Socket



Figure 1.2b

LCD88W/CAT03Sept08

INTRODUCTION (Continued)

THE GR 2400 BUS AND RS485 COMMUNICATIONS PROTOCOL

LC&D devices communicate using a method known simply as half duplex RS485. This data communication method uses one twisted pair of the stranded Cat. 5 cable to transmit data; and the other three pairs to carry power to the switches.

All devices are connected in a single line (or bus). This RS485 network allows multiple items on a bus to be connected in parallel, also called "Daisy Chain" wiring.

Each item on our system has two RJ45 jacks that allow the cabling to come in on one side and go out the other.

To illustrate the "daisy chain" method, Figure 1.3 shows a diagram of an LC&D GR2400 lighting control system.

One can see how a bad connection, say at the digital switch, can prevent communication from the Master Panel /DTC from reaching the rest of the bus.

Small imperfections in the Cat. 5 cable crimps tend to be the most common "bad connections."

Though a single imperfection may only slow down the communication by a small margin it gets multiplied up over the length of the chain.

RJ45 connectors simplify the wiring and connections of our system, but the importance of having a good crimp is paramount.

Figure 1.3

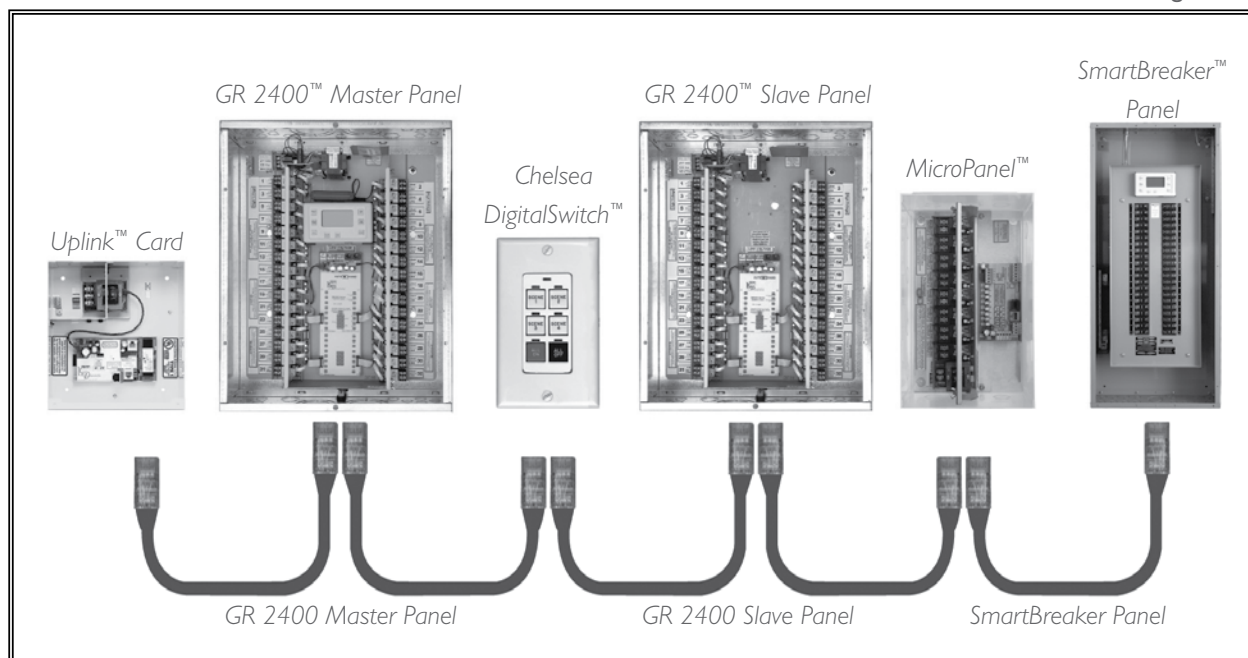

CABLE AND CRIMPING QUALITY

THE IMPORTANCE OF A PROPER CRIMP

Imperfections in a crimp adds a resistive and capacitive load at that point in the network. For example, if the voltage is dropped to 75% of its previous value at each crimp, the signal voltage will drop from 5V to 3.75V on the first crimp and 2.8V after the second.

Therefore, multiple bad crimps can cause the signal to be lost in the noise threshold after consecutive voltage drops; this loss of signal through the length of a cable is called attenuation. Impedance is the measurement of cable resistance to a signal, measured in ohms.

If the RJ45 connectors are improperly terminated, the additional resistance and capacitance at the connector changes the “character” of the wire causing what is called an impedance mismatch.

Impedance mismatch causes signal attenuation because part of the transmitted signal is reflected back much like an echo and does not reach the receiver. Inconsistent crimps compound these effects and cause a larger part of the signal to be reflected back.

When these reflected signals collide with the first discontinuity, part of the signal will return to the original

direction and create multiple echo effects. This results in an “unstable bus” because these reflections or echoes make it difficult for our devices to receive data.

Figure 1.4 shows a daisy-chained network; if there are bad crimps as described above the transmitted signal from the relay panel can lose strength with every device.

TYPE OF WIRE

There are three types of wire that use RJ45 crimped connectors. The first is a flat telephone cable, made of 26 gauge wires. It is not Cat. 5 since the wires all run parallel to each other and are not twisted and thus lack immunity to noise. We use this type cable for low frequency signals and short distances, such as to provide power to the clock.

The other two cables are round in form. They come in stranded and solid varieties. The stranded wires are used for “patch cables” from a computer to a wall socket.

Figure 1.4

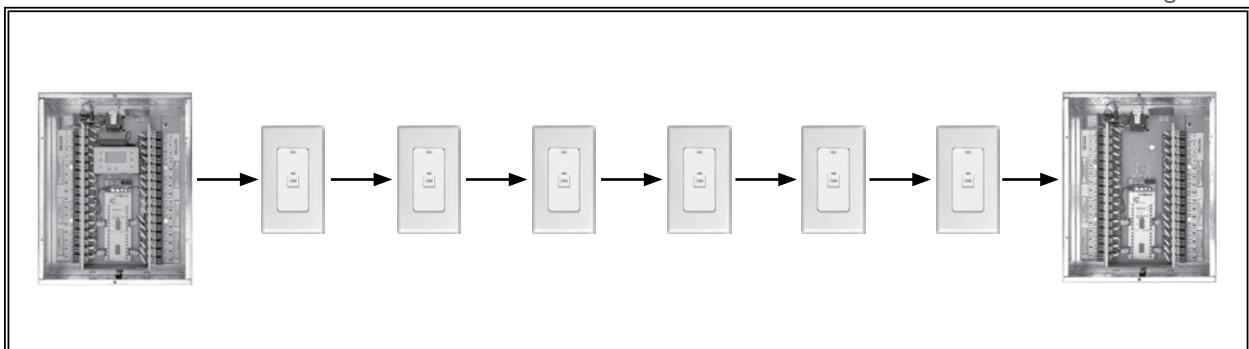

CABLE AND CRIMPING QUALITY (Continued)

Stranded wire does not fatigue as easily and break. Solid wire is usually used as "building wire." The reason being that it used to be cheaper and is not usually flexed after it has been installed. LC&D only recommends the use of stranded Cat. 5 wire.

The three types of wire have three types of crimps (Figures 1.5a & 1.5b show an RJ45 connector and three cable crimp types):

- Contacts for Stranded wires
- Contacts for Solid/Stranded wires
- Contacts for Solid wires.

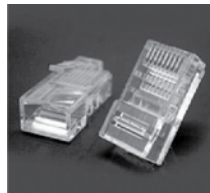

Figure 1.5a

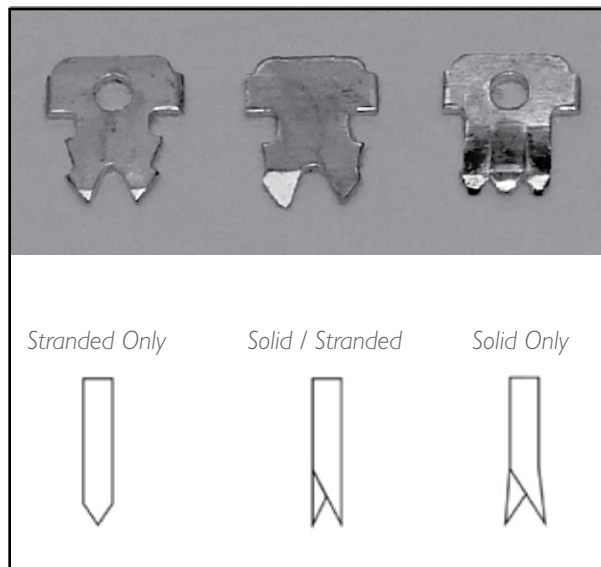

Figure 1.5b

(Note: It is very important that the correct crimps/ contacts are used for the right wire! The contacts that mate with the wires have different shapes for the different types of wire).

THE IDEAL SCENE: PROFESSIONALLY MADE COMMERCIAL CABLES

Common attributes of commercially made cables include:

- a) They always use stranded cable.
- b) The pneumatically crimped connectors have perfectly flat contacts.
- c) The strain reliefs are usually injection molded.

Figure 1.6 illustrates an example of a commercial cable. Take note of the injection molded strain relief. This prevents any movement of the connector from the cable to ensure the cable crimp stays engaged.

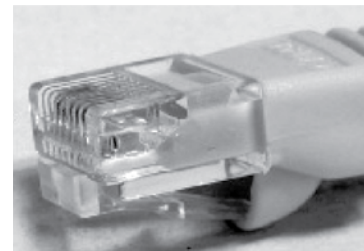

Figure 1.6

REASONS WHY IT'S HARD TO MAKE GOOD CRIMPS ON RJ45s

There are two components needed to crimp a Cat. 5 cable: a “crimper” and a “RJ45 modular connector.” A crimper is the tool used to make a crimp and seal the cable to the connector. RJ45 connectors create the interface for a connection and come in four sizes : 4-, 6-, 8-, and 10-position (position is the placement in the connector that holds a contact [pin]).

It is important to note, all crimpers and connectors are not created equal. We have performed many trials to determine a recommended crimper tool and connectors for our systems; these products will be discussed in a later section.

Note that no matter what brand of connector or crimp tool used, just the action of crimping a connector to a cable can cause it to deform and splay the connections.

Figure 1.7a

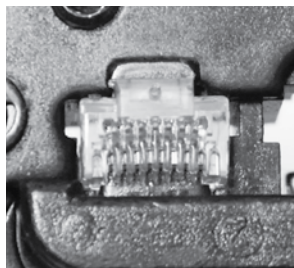

Figure 1.7b

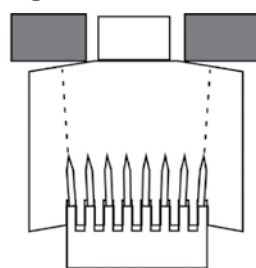
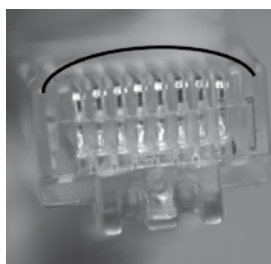

Figure 1.7a illustrates how the crimper head pushes the contacts down by the same distance but deforms the plastic case under the pressure; as you see in Figure 1.7b the contact causes the center crimp to not be adequately supported or seated. Figure 1.8 shows a crimp after release; notice how it has a “bowed” appearance.

Figure 1.8



A bowed crimp is a recipe for disaster. The two center pins do not have adequate contact with the wire. And for the purpose of LC&D lighting systems, the two center pins carry the data! The ONLY way to completely flush the

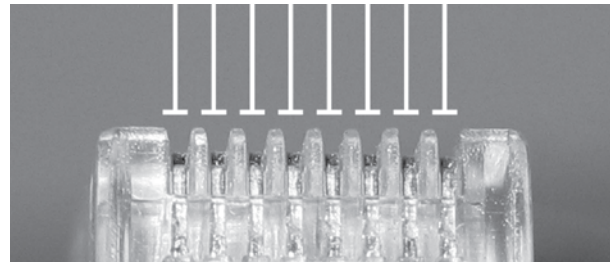

Figure 1.9a: *Contacts are seated properly.*



Figure 1.9b: *Contacts are **not** seated properly.*

center pins is to crimp multiple times (Note: we suggest 5-10 crimps for a successful Cat. 5 cable crimp) (Figure 1.9a and 1.9b are examples of properly seated and non-properly seated contacts).

SOLID WIRE IS DUCTILE

The action of pulling a cable side to side does two things:a) pulls the side wires out of the crimp and/or b) squashes the copper wire, first one way and then another. The copper “flows” into a new shape and stays there as if it has been hammered flat. An example of this pulling occurs unintentionally when a switch is pushed/forced into a tight space or wall enclosure. This can result in an “open” connection. This is why we do not recommend solid wire cable.

THE RIGHT CRIMPING TOOL

Choosing the right crimping tool is the most critical part of a cable crimping job. All crimping tools do pretty much the same thing, they force the contacts within the connectors onto the cable. But as we mentioned earlier, there is a big difference in the quality of crimps on different types of crimping tools. In trial testing, we found even the

LCD8B7W/CAT03Sept08

REASONS WHY IT'S HARD TO MAKE GOOD CRIMPS ON RJ45S (Continued)

expensive, solidly made crimping tools did not make good crimps. The best and recommended crimper is provided in the LC&D Crimping Kit. This crimping tool has no “stop” feature. The no “stop” feature allows “over-crimping” to ensure the wires are seated correctly; and thus it is possible to get the center contacts properly engaged.

THE RIGHT MODULAR CONNECTOR

After much research, we found a modular connector that is easy to setup and makes it possible to crimp a perfect Cat.5 cable every time. The brand is “EZ RJ45” (shown in figure I.11). It allows for faster terminations and is compatible with our crimper tool.

The EZ RJ45 crimp has holes in the front of the connector which allow the 24AWG wire to protrude from the end prior to crimping. (shown in figure I.11) This will ensure proper wire color arrangement and will also ensure that the wires will be pushed all the way into the end of the RJ45 connector:

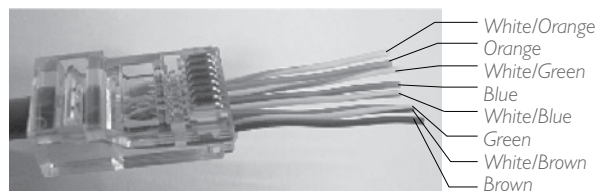

Figure I.11

The “EZ RJ45 Crimping Tool” (shown in Figures I.12a and I.12b) is specifically designed for these connectors and will cut through the excess wires protruding from the end of the RJ45 connector when crimped down.

It has some professional features such as the large crimping head but it is not capable of “over-crimping” to ensure that the center conductors have really been engaged.

Though this crimper is very convenient; it will NOT make good crimps. Use only the ratcheting crimper provided in the LC&D Crimping Kits. Thus it may ONLY be used as an initial crimper/cutter and then give the crimp multiple hits with our recommended ratcheting crimper.

One can use the “EZ-RJ45” connectors with any crimper. It just requires that the excess wire is cut off very close to the end of the connector; this can be done with flush cutters.

Care must be taken to prevent any excess wire protruding from the end of the connector since this will prevent the connector from seating properly in the jack.



Figure I.12a

There are two wiring standards used for making Cat.5 cables; 568A and 568B. Either one may be used, as long as it is consistent along the bus. This manual references the 568B convention in the examples and images.

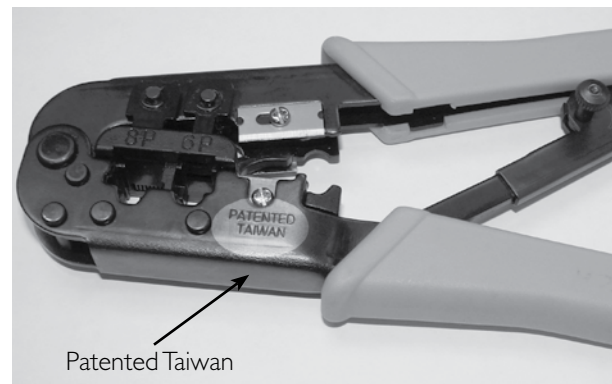

This crimper is available in the LC&D crimper kit. It is also private labeled under many brand names.

Figure I.12b

HOW TO MAKE PROPER CRIMPS

SEQUENCE OF ACTIONS

- a) Always use STRANDED cable!
- b) Only use "EZ-RJ45" brand connectors!
- c) Proper preparation of the wires is very important. Our kit comes with a wire stripper and cutter that is separate from the crimper (Figure I.13 shows a standard wire stripper/cutter)



Figure I.13

- d) Use a very light touch with the wire jacket stripper tool. Inspect the conductors for nicks, it is easy to nick the wires inside the jacket. This is especially true with stranded cables.

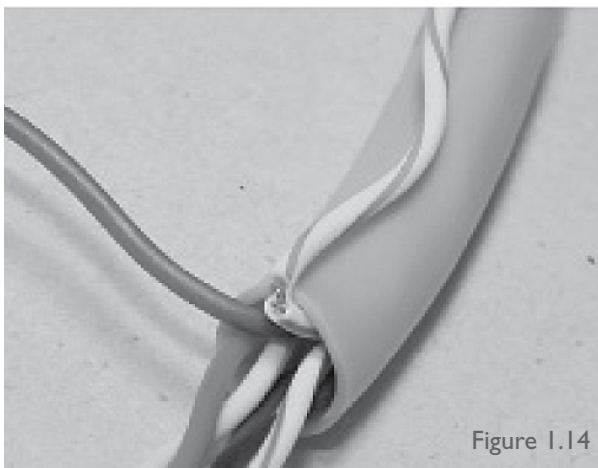

Figure I.14

- e) Untwist all four pairs and straighten/smooth out the kinks (as shown in Figure I.15).

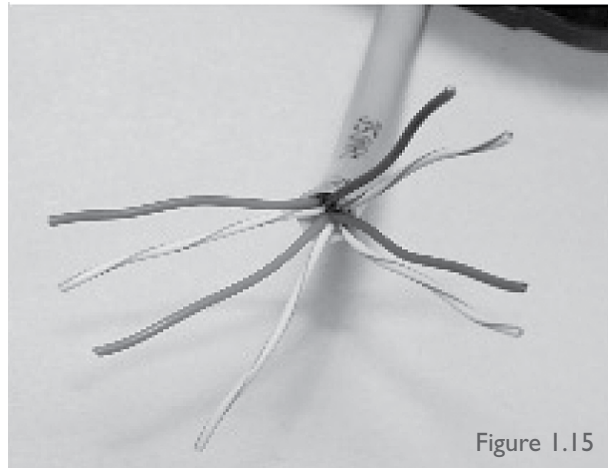

Figure I.15

Now put the wires in order. It is really easy to remember the order with the following stable datums.

- i. Every white/color wire is followed by a solid color wire.
- ii. Start with White/Orange.
- iii. The two center pairs (Green and Blue) straddle each other with the blue in the middle.
- iv. The order goes as follows:
 White/Orange
 Orange
 White/Green
 Blue
 White/Blue
 Green
 White/Brown
 Brown.

Once the wires are all in line, hold them solidly about 1/2 inch from the insulation and cut straight across the wires to get even ends. The twists in the wires are hard to smooth out at the very end so cutting prevents the wires crossing up once inside the connector.

After cutting the wires do not let go of the insulation before pushing the wires into an EZ-RJ45 connector - make

HOW TO MAKE PROPER CRIMPS (Continued)

sure the locking prongs are facing down. Make sure that the insulation is well under the strain relief and that the wires are in the right order:

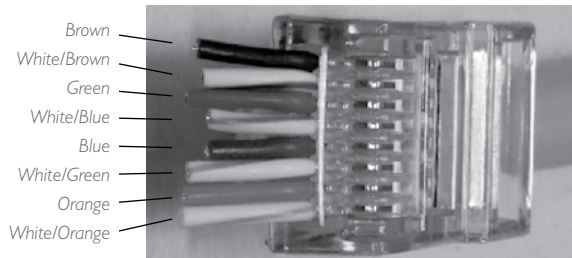

Figure 1.16

Figure 1.16 shows an example of the proper wire sequence (from right to left):

- f) Depending on preference one can cut the ends of the wires off at this point or after they have been crimped. The positive of cutting the ends off right now is that one can use flush cutters and then pull the wires back into the connector so that they are just inside prior to crimping. This may be easier than cutting the wire after being crimped. Having the wires protrude before being cut off allows one to do a double check to make sure that the color code is correct.
- g) Crimp the connector multiple times, we recommend at least 5 to 10 times. (Note: Fast hard crimps will help the contacts seat better than slow crimps.)
- h) Visually inspect the crimp! Crimps must NOT be bowed or arched. If they are, hit them again multiple times with the ratcheting crimper.
- i) If the wires have not been cut short as shown in figure 1.16, the excess wire has to be cut off right next to the connector. We want to make sure there are no stubs protruding that prevent the crimp from latching into a jack (see figure 1.17).

Figure 1.18 shows front view of a correctly made Cat. 5 cable. Observe that none of the strands are in a position to short to another strand or cause problems.

- j) Assemble the other end the same way for a straight through cable. Test each cable for continuity using a LAN tester. While testing, wiggle and tug to verify a solid crimp.

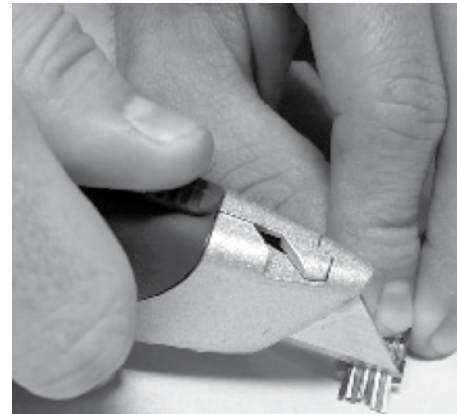

Figure 1.17

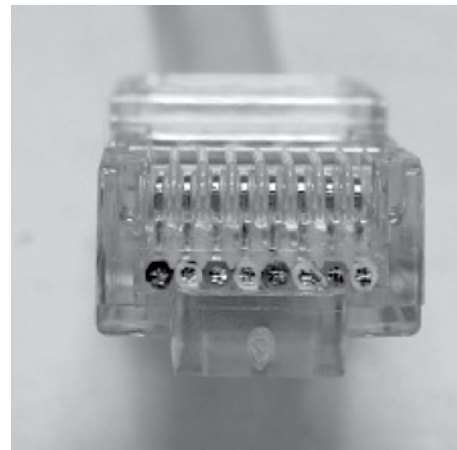

Figure 1.18

MISCELLANEOUS INFORMATION

Our cables are made up as "Straight Through" cables. The connectors at each end look identical. Notice that the green pair straddles the blue while the orange and brown take up the edges.



Never ever have a mixed pair on pins (4) and (5). Such as Blue on (4) and White Green on (5). This will cause major data loss. It is hard to find since the cable tester will tell you that the cable is OK.

An additional comment on cable testers. They only tell you if the wires have continuity from one end of the cable to the other and that they are in the same order at each



end. They do not tell you if you have good crimps or if your cables will work. The cables are part of the GR 2400 system. They are the part of the system that is manufactured in the field. Thus LC&D has the least amount of control over it. We have had cables that were tested with high end, high frequency equipment that pass individually but when plugged in end to end, the system did not work. visual inspection of each crimp however showed bowed crimps. When corrected the system was fine.

CABLE KINKS

Cable kinks cause loss of data! Cat. 5 specifications say a cable must have a radius of 1" going round a corner. Wires that have been tightened up and then straightened out cause data loss on our bus. If an electrician pulls a kink it must be cut out and the wires pulled again.

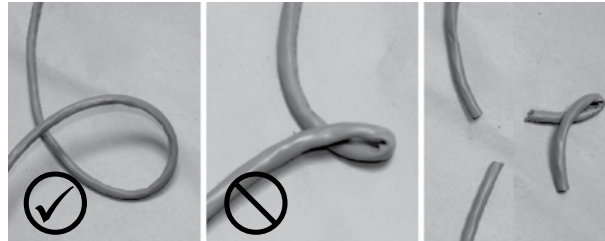

DIRTY RJ45 SOCKETS

A panel can be installed and sit in a dusty electrical room for days or months while the building is being readied. In this way the sockets can get dirty. The grit inside the socket can prevent a proper electrical connection. It may allow some contact but eventually this connection can cause problems.

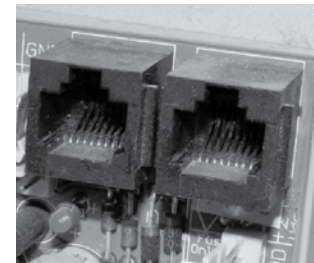

Be aware of this and make sure that the socket plugs provided are replaced if a cable is removed.

Additionally one can push the RJ45 connector into the socket upside down; this causes the gold plated spring contacts to be deformed. The only solution in this case is to replace the entire card.

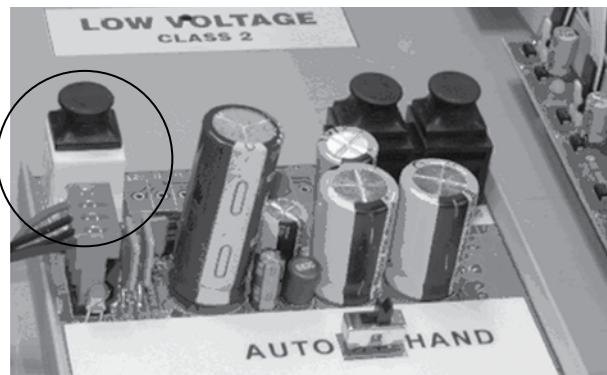

LCD8874/CAT03Sept08

MISCELLANEOUS INFORMATION (Continued)

LC&D ships all relay panels with caps for the RJ45 connectors to get rid of the possibility of contamination.

SUMMARY

There is a lot to know about making good Cat.5 cables with RJ45 connectors. The purpose of this guide is to cover the basics of crimping Cat.5 cable; which is vital to LC&D system installation, operation and maintenance. Please follow the steps outlined in this guide thoroughly; if you have any questions or need assistance call Tech Support (800) 345-4448.

STABLE DATUMS ON CRIMPING CAT.5

1. Ethernet cabling standards are different from our GR 2400 Cat. 5 cabling. Ethernet cables max out at 100m (330ft). RS485 can go to 4000ft.
2. A cable can pass a LAN cable test but still cause an unstable bus, no matter how expensive the cable tester.
3. Inconsistent crimping causes problems in a network. The expression "weakest link in the chain" really applies on a DAISY CHAINED system. If there is a bad connection in the chain, nothing on the far side of that connection can communicate back to the beginning of the chain.
4. Inconsistent crimps that may work fine on an Ethernet network may yet cause problems on a "multi-drop" or "daisy chained" bus.
5. Professionally made wires use stranded RJ45 cable. Always use stranded wire. It is only slightly more expensive than solid cable and yet can save hours and hours of tracking down and correcting bad crimps.
6. LC&D can only recommend EZ-RJ45 brand modular connectors.
7. The EZ-RJ45 brand crimper that also cuts off the wires is NOT recommended since it still produces bowed crimps no matter how many times you hit the crimp. The recommended crimper is provided in the LC&D crimper kit. It's also widely available from other suppliers who private label the same crimper. They all look the same.

8. When you crimp an RJ45, always crimp it down multiple times to ensure properly aligned and evenly seated contacts on the connector.
9. Never bend Cat. 5 with a radius of less than 1". Cut out and throw away sections of cables that have been kinked and straightened out. They can cause drop outs.
10. Always VISUALLY inspect crimps. This one action can save a lot of work. Always follow up with a cable tester once both ends of the cable have been crimped.

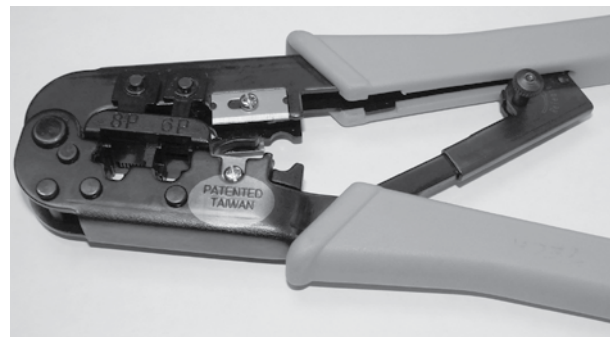

RECOMMENDED CRIMPER - Patented Taiwan



LC&D CRIMP KIT - Ships with 50EZ RJ45 Connectors and is provided at LC&D cost.

LIGHTING CONTROL & DESIGN

905 Allen Ave • Glendale, CA 91201 • Support 800-345-4448 • www.lightingcontrols.com



THE BLUE BOX™ LT

ADDING A NEW DEVICE

INSTRUCTIONS:

STEP 1:

Install new devices and note down their serial numbers on the "System Device Schedule" in the Master Panel (Refer to Installation Guides)

STEP 2:

Remove terminators from both ends of the bus.

STEP 3:

Pull Cat. 5 cable in a daisy-chain to new devices. If convenient new devices can be added to the middle of the existing bus. (Never splice Cat. 5 cable!). Add "EZ" brand RJ 45 connectors to cable ends using the proper color code. . . . Pg.41

STEP 4:

Test new cables with a LAN tester and once passed plug each in. Do not power-up devices until Step 7.Pg.41-42

STEP 5:

Verify proper connections and cabling for the entire bus using the Hardware Activation Tests.Pg.42

STEP 6:

Make up low voltage cabling and connections for contact closure devices and photocells. . . (See Installation Guides)

STEP 7:

Power-up and auto-address new devices. Pg.43

STEP 8:

Verify the system is operating without errors. . . .Pg.45-46

STEP 9:

Begin Programming.(See O&M Manual)

Digital Network:

Locate multiple Blue Box LTs and control stations where you need them and then link them all with Cat. 5 cable. One master panel (with a Digital Time Clock) for 16 digital devices. Control stations provide combined manual control and after-hours override.

Note: The photocell is not on the digital bus and should not be connected until Step 5.

Slave Relay Panel



Chelsea Digital Switch



Slave Relay Panel



Master Relay Panel

Outdoor Photocell



LCDBRAN1D04Sept08

LOW VOLTAGE CABLING

Digital devices have two RJ45 connectors and are daisy-chained using Cat. 5 (see cover). Non-digital devices (photosensors, toggle switches, etc.) are cabled per their installation guides (not daisy-chained).

- ! Adhere to 568A or 568B standards for Cat. 5 cables.
- Always use a dedicated pair for the center pins.

Refer to individual product installation guides for line-voltage cabling details and low voltage connection details. Do not “home run” digital switches back to a relay panel. No spurs or T-Taps are allowed. Do not exceed 16 devices on any system with a Blue Box LT Master.

ELIMINATE INTERFERENCE; ISOLATE CAT. 5 CABLES

...From Line Voltage Cable: Cat. 5 cable must be at least 12" from all line voltage conductors, except to cross or make terminations.

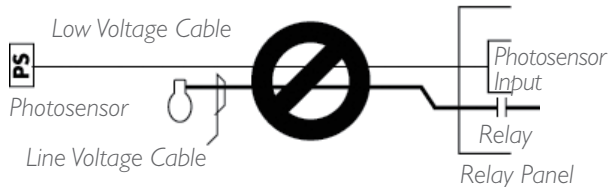

Low voltage cabling must not be run in parallel with line voltage cable, and must not share the same conduit, whether digital cable (Cat. 5) or low voltage cable (3#18 from a photosensor).

...From Line Voltage Devices: Low voltage cabling must avoid EMF or RF from ballasts, arc welders or other “noisy” loads. EMF or RF interference can create an unstable bus.

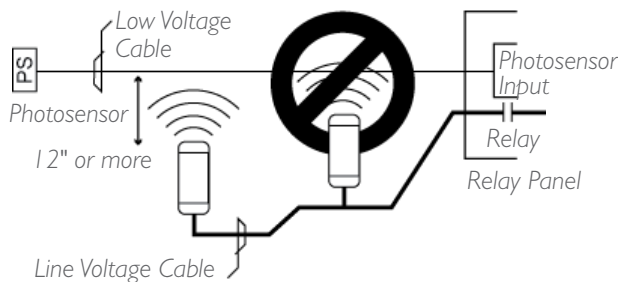

DON'T CAUSE VOLTAGE DROP!

There is a limit to how many switches and photocell cards you can add in a row over long runs of Cat. 5 cabling.

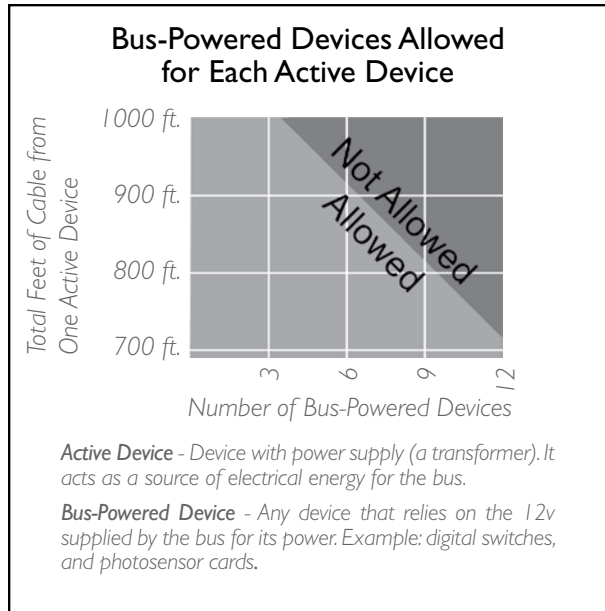

The more feet of Cat. 5 cable used, the fewer bus-powered devices before adding another active device.

Examples: Per the above chart, up to 3 bus-powered devices may be powered across 1,000 feet of Cat. 5 cable.

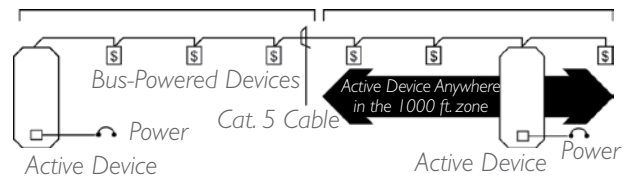

The active device may be located anywhere within the 1,000 foot region.

Multiple active devices in the same location will not increase the distance allowed.

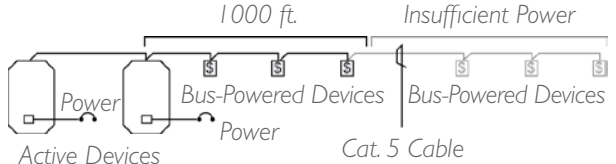

For the above, the correct solution is to connect the active devices (relay panels) as the center of the network and have two runs of cable. Call the Tech Support if cable runs exceed 1000ft without active devices.

MAKING UP RJ45 CONNECTORS

Never made up RJ45 connectors before? Its easy. Just follow the steps below. For a short lesson on making RJ45 connectors, refer to The Blue Box LT "O&M Manual".

To be successful, only use the ratcheting crimping tool recommended by LC&D and a Local Area Network (LAN) cable tester that allows remote testing — the ends of the cable will be remote from each other.

! Only use stranded Cat. 5 cable.

! Only use EZ RJ45 brand connectors provided by Lighting Control & Design (LC&D).

1. Remove two inches of the Cat. 5 jacket - use the wire stripper and cutter provided in our kit. Carefully inspect the conductors for nicks.
2. Untwist all four pairs, and straighten/smooth out each conductor.
3. Reorganize the conductors in the order shown in the illustration below. Bring all conductors together until they touch.

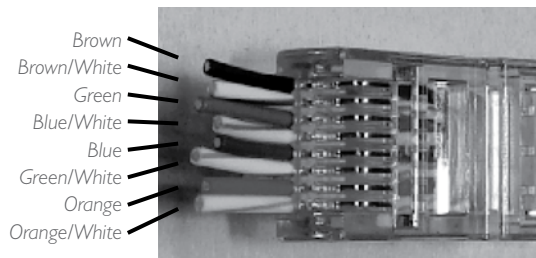

4. Place an EZ connector on the end of the cable with the locking prong facing down.
5. Push conductors completely through and (using flush cutters or box cutters) trim-off all excess cable. Conductors should butt up to the end of the connector — they must not protrude or be too short.

! Always follow acceptable safety procedures when using a sharp cutting tool. Tools must be sharp; dull tools cause more hazards than sharp ones.

6. Using the recommended ratcheting crimp tool, crimp at least five times for the best possible connection.



Contacts were not correctly cut off - will prevent proper seating in socket.

7. Visually inspect each connector: Contacts should be pushed into the insulation of each conductor.
8. Repeat on the other end of the cable for a straight-through cable.



Contacts not seated properly (bowed crimping).

9. Test every cable for continuity with a LAN cable tester. While testing, wiggle and tug on each connector to test for a solid crimp.

Never make "hot" RJ45 crimps (crimping the other end of a cable that has been plugged into a powered device). This can damage equipment.

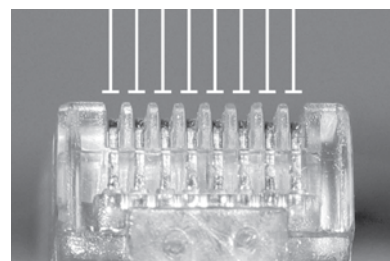

Contacts properly seated (flat crimping).

HARDWARE ACTIVATION TESTS

Before starting, note total approximate bus cable length:

--

Once each cable has been checked with a LAN cable tester and plugged-in, it is still possible for the entire connected cable structure to be problematic. For instance, dirt may have accumulated inside the RJ45 sockets, the strain on the Cat. 5 when pushing switches into the wall may weaken connections or even break the conductors, or the bus length may exceed 4000 ft.

Each test must be passed before moving onto the next. If any readings are out of range, refer to "Hardware Activation Troubleshooting" section at the end of this document or call Technical Support at 1-800-345-4448.

CONTINUITY TEST

This test is intended to verify bus length, continuity, and detect crossed data-pair wires.

1. De-power every item on the bus and check the voltage at both ends to ensure a reading of 0vdc. Remove any terminators.
2. At one end of the bus, plug in the "Data/Power Jumper."
3. At the other end of the bus, plug in the "Bus Checker Card" and measure resistance across the following terminals:

Gnd to A	___ohms	B to +12	___ohms
----------	---------	----------	---------

4. All test values must be within 10% of the values in the chart below to be considered valid!

Continuity Test Results (Gnd to A & B to +12)

Length	Ohms	Length	Ohms
100 ft	3 Ω to 6 Ω	2000 ft	68 Ω to 80 Ω
500 ft	12 Ω to 20 Ω	3000 ft	102 Ω to 120 Ω
1000 ft	34 Ω to 40 Ω	4000 ft	130 Ω to 160 Ω

SHORT CIRCUIT TEST

This test is intended to detect any short circuits along the bus. Please use the lowest resistance range (200 Ω) setting on your multimeter. DO NOT use a "beep" test.

5. Remove the "Data Power Jumper." On the "Bus Checker Card," measure the resistance across the following terminals:

6. All test values should be greater than 1K ohm!

Gnd to A	___ohms	A to B	___ohms
Gnd to B	___ohms	A to +12	___ohms
Gnd to +12	___ohms	B to +12	___ohms

EARTH GROUND TEST

This test is intended to detect any pathways to earth ground.

7. Measure resistance between the terminals mentioned below, and "Earth ground" (a metallic enclosure or conduit).

Gnd	A
+12	B

8. All readings between each terminal and "Earth ground" should be infinite or "Open"!

TERMINATOR TEST

This test is intended to ensure that only 2 terminators exist, one at each end of the bus. If the readings are out of range, it would indicate a missing, misplaced, or an extra terminator.

9. Add a "Terminator" on the first and last device. On the "Bus Checker Card", measure

A to B	___ohms
--------	---------

10. Test reading should be within 62 Ω to 92 Ω !

11. Remove the bus checker card and call our Tech Support with your results at: 1-800-345-4448 x391.

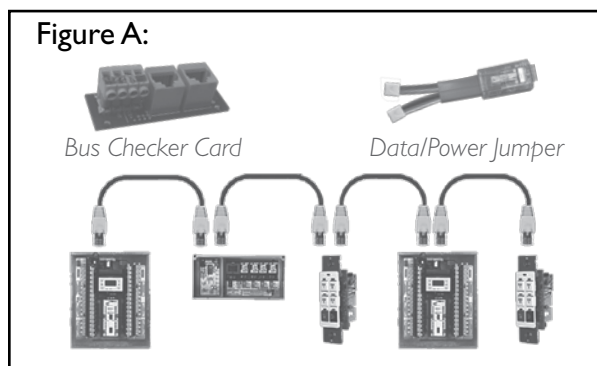

AUTO-ASSIGNING ADDRESSES TO A NEW DEVICE

Any newly added digital device (switch, relay panel, DI card, etc) to any system with a Blue Box LT Master panels may be auto-addressed as follows:

1. After completing the product Installation Guide(s), power up all Slave Panels, and active devices (any device with an onboard - 120 or 277 - power supply) first and then power up the Master Panel. Check that the power-indicator LEDs on all digital devices are lit-up.
2. The main screen will be displayed for a few seconds, after which the following will be displayed. TAB to YES and press ENTER to auto-address the new device(s). If the number of devices detected do not match the number of devices present on the bus, proceed to trouble-shooting section.

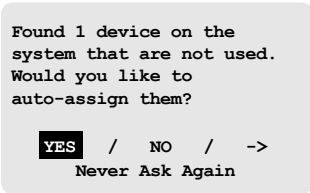

3. To view address assignment, TAB to YES and press ENTER to go to the "Serial Number Scan" screen.

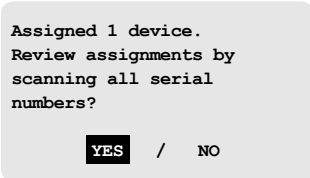

The "Serial Number Scan" screen displays the serial number, address, and device-type of any newly added device(s)

4. If adding more than one device, TAB to "Serial#" field and SCROLL UP or DOWN to review each device.

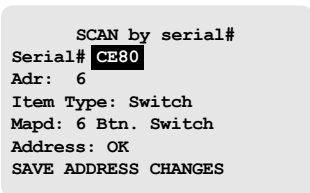

5. Add the new device(s) to the "System Device Schedule" on the back of the "Panel Schedule" located inside the Blue Box LT Master Panel for future programming.

(Master) LCP1 Device Type elec rm Location ce80 Serial # 1 Address	3 btn sw Device Type Hallway Location 8875 Serial # Address	6 btn sw Device Type lobby Location 4685 Serial # Address
DI-6 Device Type LCP 1 Location 4055 Serial # 7 Address	Device Type Location Serial # Address	Device Type Location Serial # Address

Not sure what the serial numbers are? Each device has a unique Serial Number label or do the following to "read" the Serial Number from the DTC clock:

- a. Navigate to the "Read Address" screen: USER MENU > SETUP MENU > RESTRICTED > ADDRESSING-BUS SCAN > READ ADDRESS. The password to enter the RESTRICTED area is 900001.
- b. Press the first button on a switch or the "Address/Assign" button. The screen will display the "Address" and "Serial number". Record this data on the System Device Schedule.

ERROR CHECK

The system is now ready for Error Checking. EXIT repeatedly to navigate to the main menu.

6. Navigate to the Error Statistics Screen. Use the path USER MENU > SETUP MENU > RESTRICTED > ADDRESSING-BUS SCAN > ERROR STATISTICS.
7. Tab to the field that says CLEAR and press ENTER to clear errors. If after 3 minutes no errors accumulate on this screen, your system is stable.
8. If errors continue to accumulate, refer to the "Error Check Troubleshooting" section in the Blue Box LT O&M Manual or System Start-Up and Cabling Guide or call Technical Support: 1-800-345-4448.

DIGITAL TIME CLOCK (DTC) NAVIGATION BASICS

DTC CLOCK NAVIGATION BASICS

All devices can be programmed from the DTC (Digital Time Clock) in the master Lighting Control Panel (LCP).

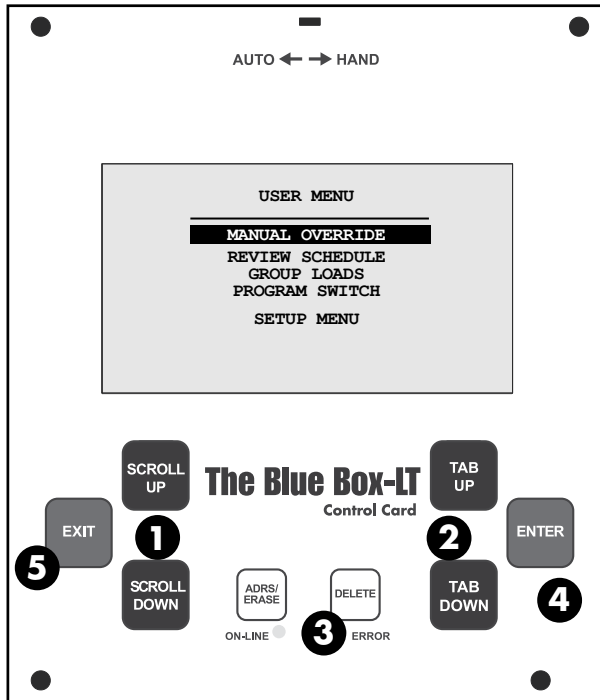

TAB moves the cursor through a screen

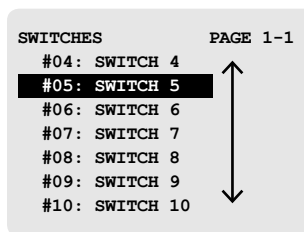

SCROLL to choose one item from a field.*

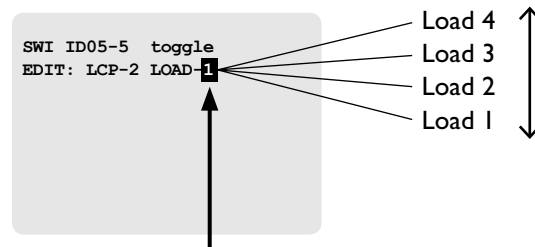

This "field" contains a list of possible selections, but only displays one item from that list at a time.

CALL OUT LEGEND:

1. SCROLL through choices in one field*
2. TAB to position the cursor
3. DELETE information or programming about an item. Use caution.
4. ENTER to select
5. EXIT to leave a screen.

* A "field" is a display in which many items can be selected.

HARDWARE ACTIVATION TROUBLESHOOTING

! Always re-check “failed” results. If improperly set or connected a meter can display unusual readings during testing.

! The “Bus-Splitting Technique” is the fastest way to find a bad cable and/or damaged device. Be sure to document the cable path!

! Cat. 5 cables that pass a LAN cable test can still short or break from stress and strain during installation. If re-testing a suspected cable with a LAN tester, roughly wiggle and tug the conductors (cable wires) near the RJ45 connector to ensure the conductors are properly engaged.

CONTINUITY TEST TROUBLESHOOTING

1. Fluctuating resistance readings indicate one or more “active” devices are still “hot”. De-power all devices and re-test.
2. High resistance readings indicate broken or resistive connections. Use the “Bus-splitting” technique to find:
 - RJ45 connectors not properly pushed into sockets (check to make sure that the wires are not extended beyond the end of the RJ45 connector)
 - Cable strain can break conductors or pull conductors out of RJ45 contacts (visually inspect cable and connector).
 - Unseated RJ45 sockets (rough install environment)
 - Damaged device (rare)
 - Dirt or paint on RJ45s (rare)
 - Bad data/power jumper cable (rare)

SHORT CIRCUIT TEST TROUBLESHOOTING

1. A low resistance reading indicates a crossed or shorted pair or (rarely) a damaged device. Cable strain when pushing switches into a wall can short nicked conductors. Use the bus splitting technique to find the bad cable, crimp or device.
2. Resistance readings below 300Ω on A-B only indicate an extra terminator. Use the bus splitting technique to find the short or extra terminator.
3. After the problem has been resolved, please complete the “Continuity Test” again.

UNSTABLE BUS TROUBLESHOOTING

1. Ensure terminators are present at both ends of the bus.

EARTH GROUND TROUBLESHOOTING

LAN-tested cables can still have a path to earth ground.

1. An abraded or “folded” cable inside the conduit will cause a short to earth ground.
2. Other low voltage or high voltage wires touching any device on the bus will cause continuity to earth ground

Use the Bus Splitting Technique to locate the problem.

TERMINATOR TROUBLE-SHOOTING

1. Ensure that the Data/Power Jumper is removed.
2. Visually inspect both terminators are present and properly seated on each bus-end device.

ERROR CHECK TROUBLESHOOTING:

If the hardware activation tests have just been completed and the bus is unstable, consider the following causes:

1. Failure to follow the 568A or 568B color code (or minimally to use a dedicated pair for the center pins) will cause the Error Check test to fail. Visually inspect RJ45 connectors.
2. Occasionally the flat-cable connecting the clock to the Master panel can become damaged. Visually inspect the Cat. 5 cable – if damaged, replace it with a new cable.
3. An external source of EMF (electro-magnetic frequency) or RF (radio frequency) interference may be affecting the bus (or digital devices). Refer to the beginning of this guide on running low voltage cables across or parallel to line voltage cables or exposing low voltage cables to EMF or RF sources (e.g. welders, ballasts, improperly grounded wireless devices, etc.); any of which can interfere with the bus operation and stability.

Visually inspect and handle any external sources of signal noise - a digital device can also become damaged and create signal noise.

An oscilloscope can be used to locate the source of the bus failure. The Oscilloscope Test procedures can be found in The Blue Box LT “O&M Manual”. If unfamiliar with how to use an oscilloscope or if one is unavailable on-site, contact Tech Support: 1-800-345-4448.

HARDWARE ACTIVATION TROUBLESHOOTING (Continued)

BUS SPLITTING TECHNIQUE

! Note: To speed up troubleshooting when readings are less than 200Ω on the Continuity or Short-Circuit test, refer to the “Bus Length Chart” earlier in this document before splitting the bus; this can provide an approximate distance to a shorted pair or extra terminator from the test point.

1. On the middle device of the bus, disconnect one Cat. 5 cable to create two smaller “half-buses”.
2. Test each “half-bus” to find the side with the out-of-range values.
3. Repeat steps 1 & 2 on the out-of-range “half-bus,” to create another “half-bus” until the cable, crimp or device creating the out of range measurements is located.

The idea is to split a bus in half and then half again – over and over until the bad area has been located. It is OK to visually inspect each cable, crimp or device to detect the problem.

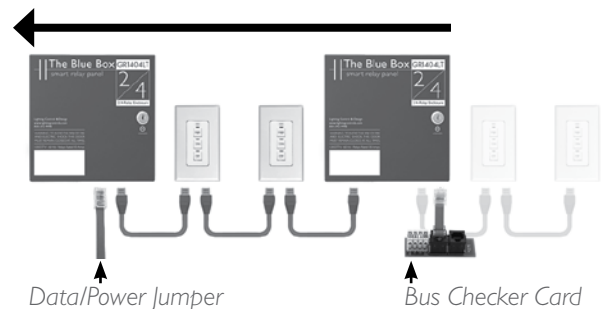
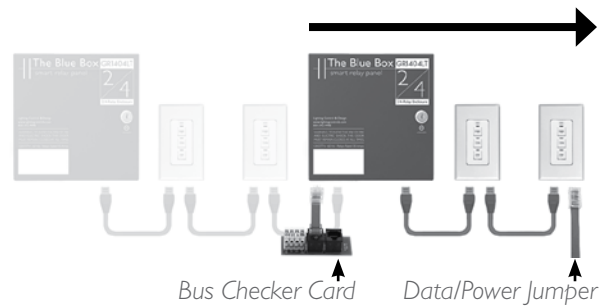
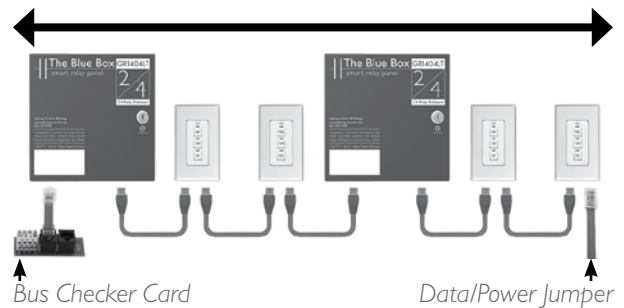

LIGHTING CONTROL & DESIGN

905 Allen Ave • Glendale, CA 91201 • Support 800-345-4448 • www.lightingcontrols.com

LCDBRANID04sept08



THE BLUE BOX™ LT

PARTS REPLACEMENT & INSTALLATION GUIDE

LCDB88R1G03Sept08



Lighting Control & Design
905 Allen Ave, Glendale CA 91201
Tel: 800-345-4448 • www.lightingcontrols.com

LIGHTING CONTROLS

LC&D recommends that any suspect circuit be fault-checked prior to re-energizing.

RELAY REPLACEMENT AND INSTALLATION

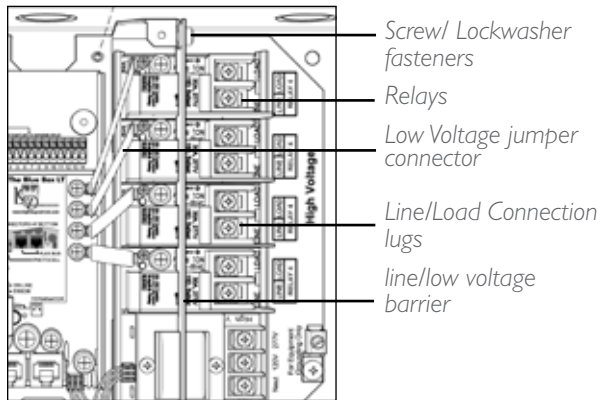

To remove a defective relay:

1. Switch off all breakers feeding relays and the transformer in the Blue Box LT.
2. For master panels: Unscrew and open the hinged display-panel door to expose the high-voltage section.
3. Remove the screw and lockwasher fasteners that hold the line/low voltage barrier over the relays.
4. Pull off the low voltage jumper that connects the relay to the control card (LT 4 & 8) or the smacker strip (LT 16).
5. Loosen the LINE and LOAD connection lugs on the relay and remove the conductors. [Note: For safety reasons, use a wire nut to tie the two wires together]

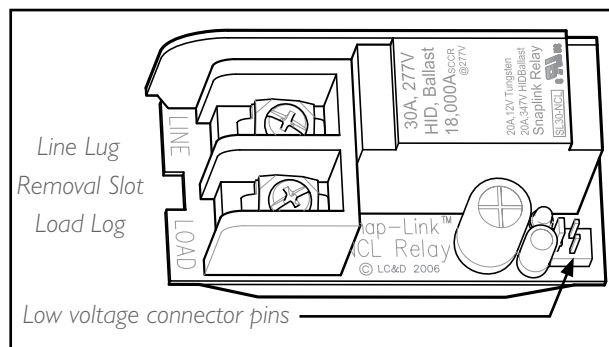

6. Pry the relay out of the plastic track by applying a flat-blade screw driver to the slot located at the relay card's edge near the line and load lugs.

To replace a defective relay

7. Push the replacement relay back into the track until it "snaps" securely in place – use a flat-blade screw driver to snap in one or both ends.
8. Reconnect the low voltage jumper between the relay and the relay driver pins on the control card (LT4 and LT8) or the smacker strip (LT 16).
9. Re-install the line/low voltage barrier and the screw and lockwasher fasteners. If necessary, break out the "break-away" tab(s) (one for each new relay) on the voltage barrier for the replacement relay(s).
10. Reconnect Line and Load conductors to the connection lugs.
11. For master panels: Close and screw down the hinged display-panel door.
12. After the defective part replacement installation is complete, return the part using the prepaid USP return label and envelope to LC&D.

[Note: If the defective part is not returned within a 30-day period, your account will be automatically billed for the part.]

To exercise and test the replacement relay:

13. Switch the breakers powering all the relays and the transformer back ON
14. Navigate on the DTC to USER MENU > MANUAL OVERRIDE and TAB or SCROLL to the correct LCP and Load (relay) and ENTER to exercise the relay by switching it on and off 3 or 4 times. If possible, listen to hear the relay contacts clicking as they open and close.

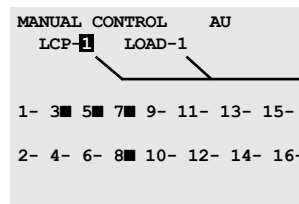

SCROLL to select LCP
TAB to LOAD
SCROLL to select LOAD
ENTER to toggle status

Refer to the Digital Input Card Installation Guide section of the Blue Box LT "O&M Manual" for more details.

DI CARD REPLACEMENT AND INSTALLATION

To remove a defective DI Card:

1. Note the address of the existing DI Card. Refer to the SYSTEM DEVICE SCHEDULE in the master panel or by process of elimination - the READ ADDRESS screen.
2. De-power the Blue Box LT by switching off the breaker feeding the power supply (the relays in that panel will close).
3. Disconnect the power/data jumper cable from the DI card (leave it connected to the control card).
4. Remove all low voltage conductors for contact closure devices from the input/output terminals.
5. Pry the DI Card out of the plastic track by applying a flat-blade screw driver to the slot on the side of the card.

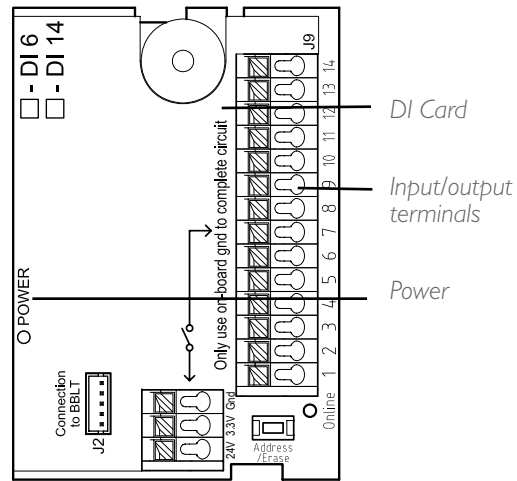
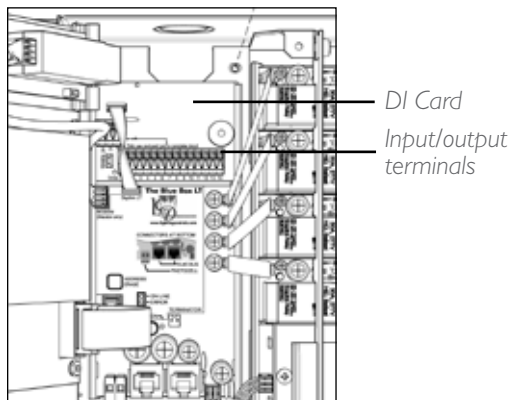

To replace a defective DI Card

6. Snap the new DI card into the plastic track .
7. Re-connect the power/data jumper cable to the DI card.
8. Reconnect all low voltage conductors for contact closure devices to the input/output terminals.
9. Re-power the Blue Box LT.
10. If this is a master panel, the main screen will be displayed for a few seconds, after which the "device detection" screen will be displayed. **DO NOT ASSIGN THIS DEVICE A NEW ADDRESS! TAB to NO and ENTER**
11. When the screen prompts: "Are you sure?" TAB to YES and ENTER.
12. After the defective part replacement installation is complete, return the part using the prepaid USP return label and envelope to LC&D.

[Note: If the defective part is not returned within a 30-day period, your account will be automatically billed for the part.]

To address the replacement DI Card

13. Navigate to the AUTO-ADDRESSING screen: USER MENU> SETUP MENU> RESTRICTED (PASSCODE: 900001) > ADDRESSING-BUS SCAN > AUTO ADDRESSING.

```

DEVICE MANAGEMENT

SCAN BY SERIAL #
ERASE ALL ADDRESSING
AUTO ADDRESSING
SCAN FOR ZERO ID ON
POWER UP: YES

```

14. SCROLL UP until the address of the previous DI is displayed.
15. Press the address button on the DI CARD.
16. If the DI “takes” the address, the display will increment by one (e.g. from “3” to “4”).

To verify the bus recognizes the replacement DI Card:

17. Navigate to SCAN BY SERIAL NUMBER screen: USER MENU > SETUP MENU > RESTRICTED (PASSCODE 900001) > ADDRESSING – BUS SCAN> BUS DIAGNOSTICS > MORE DIAGNOSTICS > DEVICE MANAGEMENT > SCAN BY SERIAL#

```

SERIAL# SCAN
BACK FWD |SAVE|
SERIAL# CE80
ADR: 1
LCP
NO ADDRESS COLLISION FOUND
ON THIS CARD

```

18. ENTER to begin a system scan.
19. If the screen shows no collisions, DI Card replacement is complete.
20. If collisions exist, contact Technical Support.
21. Reconnect all low voltage conductors for contact closure devices to the low voltage input/output terminals.
22. Program the new DI card.

CONTROL CARD [MASTER] REPLACEMENT AND INSTALLATION

To remove a defective Control Card

1. De-power the Blue Box LT by switching off the breaker feeding the power supply (the relays in

that panel will close).

2. Once the panel is de-powered, disconnect all cables connected to the control card.
3. Pry the Control Card out of the plastic track by applying a flat-blade screw driver to the slot on the side of the card.

To replace a defective Control Card

4. Snap the new control card into the plastic track.
5. Re-connect all cables and conductors to the control card.
6. Re-power the Blue Box LT
7. After the defective part replacement installation is complete, return the part using the prepaid USP return label and envelope to LC&D.

[Note: If the defective part is not returned within a 30-day period, your account will be automatically billed for the part.]

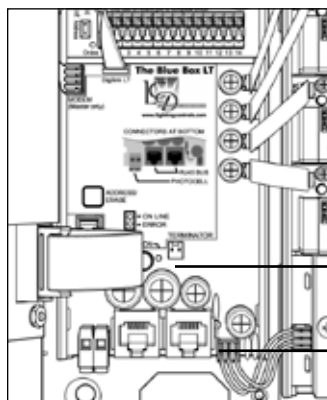

Master Control Card

Power

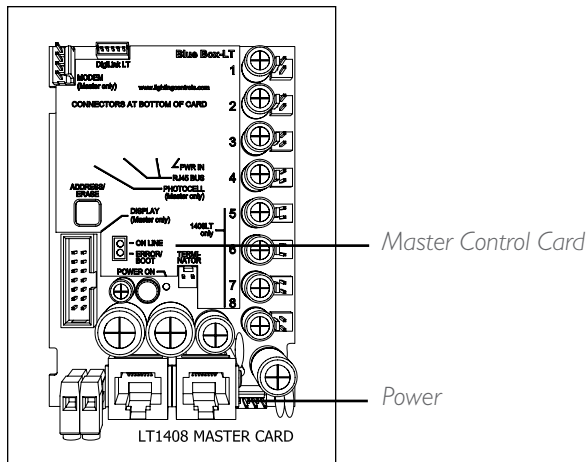

To address and verify the bus recognizes replacement Control Card

The Blue Box master Control Card contains the time clock for the system. To save time, the time, date and location settings can be pre-loaded at the factory - if requested. Time schedules and any groups which had Loads (relays) in LCP 1 (master panel) will need to be re-programmed.

If your system has a modem, contact Technical Support to have all of the programming (listed below) done.

8. Navigate to SCAN BY SERIAL NUMBER screen: USER MENU > SET UP MENU > RESTRICTED (PASSCODE 900001) > ADDRESSING – BUS SCAN> BUS DIAGNOSTICS > MORE DIAGNOSTICS > DEVICE MANAGEMENT > SCAN BY SERIAL#
9. ENTER to begin a system scan.

```
SCAN BY SERIAL#

SCANNING COMPLETE.
FOUND 3 ITEMS.
NOT ADDRESSED: 0
HIT ENTER WHEN READY
```

10. If the Screen shows no collisions SCROLL through each device noting down the address (ID) and the device type (3 button switch, etc)

11. If collisions exist, contact Technical Support.
12. If no collisions exist or collisions have been resolved, the bus needs to be mapped so that the devices can be programmed. Navigate to the BUS MAP screen: USER MENU > SETUP MENU > RESTRICTED (PASSCODE 900001) > ADDRESSING – BUS SCAN> BUS MAP.

```
ADDRESSING PAGE 1-19
ID1 : UNUSED
ID2 : UNUSED
ID3 : UNUSED
ID4 : UNUSED
ID5 : UNUSED
ID6 : UNUSED
ID7 : UNUSED
```

13. To define the Master Blue Box, TAB to ID1 and SCROLL to select Panel LCP 1 (4 or 8 relay panels). For a 16 relay panel, TAB to ID2 and SCROLL to “Panel LCP 1” also. Every 8 relays take up an address, so a 16 relay panel will take up 2 addresses.

```
ADDRESSING PAGE 2-19
ID1 : PANEL LCP1
ID2 : PANEL LCP1
ID3 : UNUSED
ID4 : UNUSED
ID5 : UNUSED
ID6 : UNUSED
ID7 : UNUSED
```

14. Map the remaining devices into the BUS MAP screen using the data from the SCAN BY SERIAL NUMBER screen

Item	Bus Map Name
Blue Box LT-4	Panel LCP X (1-32)
Blue Box LT-8	Panel LCP Y (1-32)
Blue Box LT-16 (Blue Box LT 16 requires two addresses)	Panel LCP Z (1-32) Panel LCP Z (1-32)
1 button digital switch	1 Btn. Switch, etc
DI-14	14 Btn. Switch

LCD88RPG03Sept08

Item	Bus Map Name
DI-6	14 Btn. Switch
Any Digital Switch that is enabled or disabled	14 Btn. Switch

Re-program schedules and groups

- Since the master panel control card is also the system clock, all programs will need to be programmed back into the clock.
- Any groups which had relays in LCP 1 will need to be modified to add back the relays from LCP 1. Relays from other LCPs will automatically appear on the Groups screens.

CONTROL CARD [SLAVE] REPLACEMENT AND INSTALLATION

To remove a defective Control Card

- Note the address of the LCP (lighting control panel). Refer to the SYSTEM DEVICE SCHEDULE in the Master Panel or use the READ ADDRESS screen.
- De-power the Blue Box LT by switching off the breaker feeding the power supply (the relays in that panel will close).
- Once the panel is de-powered, disconnect all cables connected to the control card.
- Pry the Control Card out of the plastic track by applying a flat-blade screw driver to the slot on the side of the card. [Note: If this is a warranty replacement, do not forget to ship relay back to LC&D.]

To replace a defective Control Card

- Snap the new control card into the plastic track.
- Re-connect all cables and conductors to the Control Card.
- Re-power the Blue Box LT.
- After the defective part replacement installation is complete, return the part using the prepaid USP return label and envelope to LC&D.

[Note: If the defective part is not returned within a 30-day period, your account will be automatically billed for the part.]

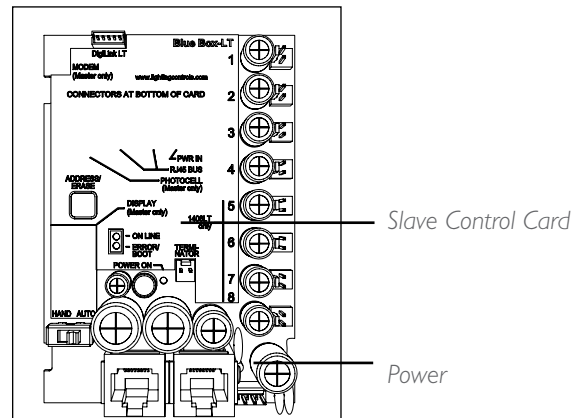
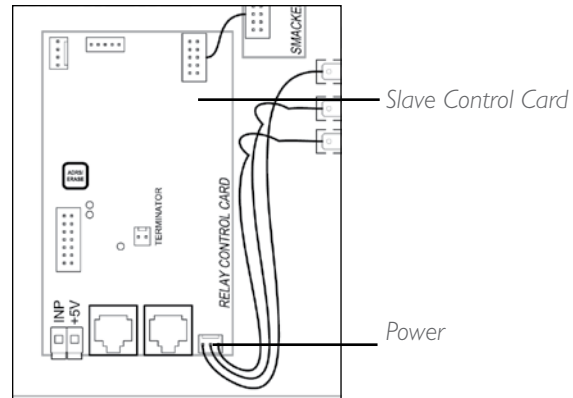

To address and verify the bus recognizes replacement Control Card

- Navigate to the AUTO ADDRESS screen: USER MENU > SET UP MENU > RESTRICTED (PASSCODE: 900001) > ADDRESSING BUS SCAN > AUTO ADDRESSING.
- SCROLL UP until the address of the LCP is displayed.
- Press the address button on the Control Card.
- If the address "takes" the address on the display will increase by one for an LT4 and LT-8, or 2 for an LT-16) (e.g. from "3" to "4").

13. Navigate to SCAN BY SERIAL NUMBER screen: USER MENU > SETUP MENU > RESTRICTED (PASSCODE 900001) > ADDRESSING – BUS SCAN> BUS DIAGNOSTICS > MORE DIAGNOSTICS > DEVICE MANAGEMENT > SCAN BY SERIAL#

```
SERIAL# SCAN
BACK FWD |SAVE|
SERIAL# CE80
ADR: 1
LCP1
NO ADDRESS COLLISION FOUND ON
THIS CARD
```

14. ENTER to begin a system scan.
15. If collisions exist, contact Technical Support.
16. If no collisions exist or collisions have been resolved, the bus needs to be mapped so that the devices can be programmed. Navigate to the BUS MAP screen: USER MENU > SETUP MENU > RESTRICTED (PASSCODE 900001) > ADDRESSING – BUS SCAN> BUS MAP.

Re-program Groups

17. Any Groups which had relays in the LCP with the new control card will need to be modified to add back the relays from that LCP. Relays from other LCPs remain unaffected.

REPLACING A MODEM (MASTER PANELS ONLY)

To remove a defective modem

1. Disconnect the power/data cable connected to the modem.
2. Disconnect the RJ-12 (phone line)
3. Pry the modem out of the plastic track by applying a flat-blade screw driver to the slot located on the side of the card.

To replace a defective Modem

4. Snap the new modem into the plastic track .
5. Re-connect cables.
6. Re-power the Blue Box LT

7. After the defective part replacement installation is complete, return the part using the prepaid USP return label and envelope to LC&D.

[Note: If the defective part is not returned within a 30-day period, your account will be automatically billed for the part.]

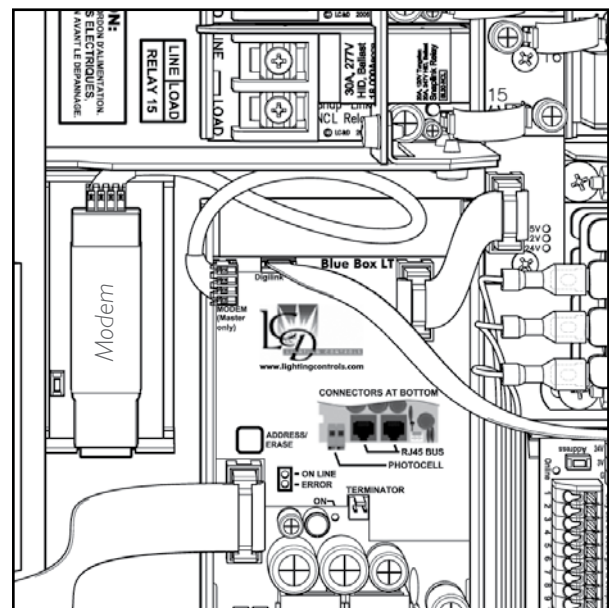

To verify replacement modem is operational:

8. Navigate to the DIAL UP HOST screen: USER MENU > SETUP MENU > RESTRICTED (PASSCODE 900001) > REMOTE SYSTEM MENU > DIAL UP HOST

```
DIALING UP HOST

ENTER THE COMPLETE
PHONE NUMBER OF THE
HOST AND HIT ENTER.
```

9. Refer to the DIAL UP HOST section in the O&M manual to place an outbound call to a cell phone or land line.
10. A successful call means installation is complete. If the call was not successful, contact Technical Support for assistance.

LCDB88RPN(G03)Sept08

DTC DISPLAY REPLACEMENT AND INSTALLATION

1. Unplug the jumper cable at the back of the DTC.
2. Unscrew the four fasteners on the back of the DTC.
3. Mount the new DTC.
4. Re-connect the new DTC.
5. After the defective part replacement installation is complete, return the part using the prepaid USP return label and envelope to LC&D.

[Note: If the defective part is not returned within a 30-day period, your account will be automatically billed for the part.]

SMACKER STRIP (BLUE BOX LT16) REPLACEMENT AND INSTALLATION

To remove a defective smacker strip

1. De-power the Blue Box LT by switching off the breaker feeding the power supply (the relays in that panel will close).
2. Once the panel is de-powered, disconnect all cables connected to the smacker strip.
3. Remove the three screws and lift the smacker strip out of the panel.

To replace a defective smacker strip

4. Mount the new Smacker Strip using the three screws.
5. Re-connect all flat cables and relay jumpers. Refer to the Blue Box LT 16 schematic drawing if uncertain about cable placement.
6. Re-power the Blue Box LT.
7. After the defective part replacement installation is complete, return the part using the prepaid USP return label and envelope to LC&D.

[Note: If the defective part is not returned within a 30-day period, your account will be automatically billed for the part.]

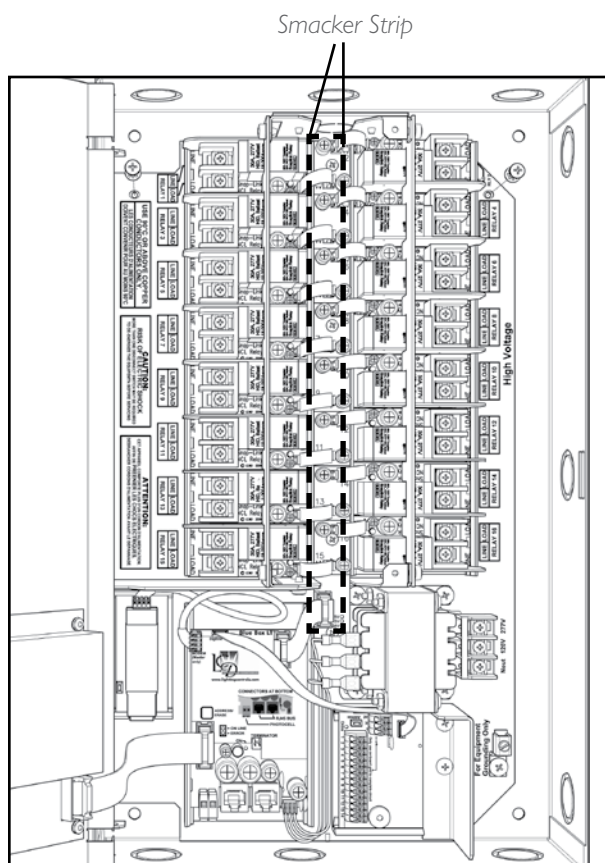

To verify proper connections:

8. To exercise and test the newly added smacker strip, navigate to the MANUAL OVERRIDE screen: USER MENU > MANUAL OVERRIDE

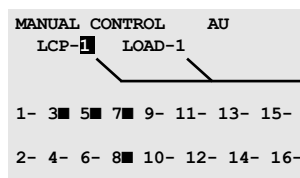

SCROLL to select LCP
TAB to LOAD
SCROLL to select LOAD
ENTER to toggle status

9. TAB or SCROLL to the correct LCP. Exercise each relay by manually switching it on and off 3 or 4 times. Make sure the relay corresponds to the Load number on the MANUAL OVERRIDE screen.
10. Correct any mis-connections.

TRANSFORMER REPLACEMENT AND INSTALLATION

To remove a defective Transformer

1. De-power the Blue Box LT by switching off the breaker feeding the power supply (the relays in that panel will close). De-power any other breakers that may present a hazard during installation.
2. For master panels: Unscrew and open the hinged display-panel door to expose the high-voltage section.
3. Remove the screw and lockwasher fasteners that hold the line/low voltage barrier on top of the power supply (transformer) and remove the barrier to free it up.

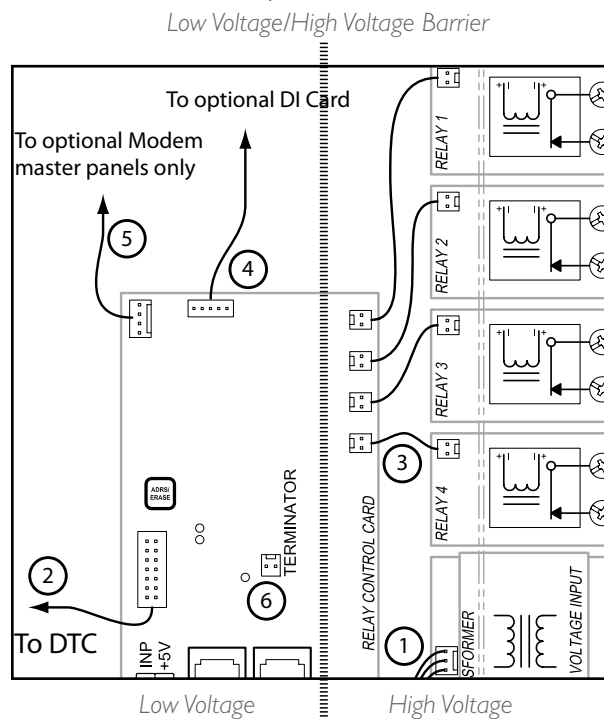

4. Loosen the hot and neutral connection lugs on the transformer's terminal block and remove the conductors.
5. Pull off the low voltage connector(s) (one wire for LT 4 and 8 and three wires for LT 16) that connects the transformer to the control card.

6. For LT 4 and 8: Pry the transformer out of the plastic track by applying a flat-blade screw driver to the slot located at the card's edge near the hot and neutral lugs. For LT 16: Remove the four screws at the base of the transformer.

To replace a defective Transformer

7. For LT 4 and 8: Push the new replacement transformer into the track until it "snaps" securely in place. You may need to use a flat-blade screw driver to snap in one or both ends. For LT 16: Mount the new transformer with the four screws.
8. Reconnect the low voltage connectors.
9. Reconnect hot and neutral conductors
10. Re-install the line/low voltage barrier and the screw and lockwasher fasteners.
11. For master panels: Close and screw down the hinged display -panel door.
12. Re-power any breakers.
13. After the defective part replacement installation is complete, return the part using the prepaid USP return label and envelope to LC&D.

[Note: If the defective part is not returned within a 30-day period, your account will be automatically billed for the part.]

To exercise the replacement Transformer

14. Visually inspect that the ONLINE LED on the control card is blinking and the clock is powered up and displaying correctly.
15. Navigate on the DTC to USER MENU > MANUAL OVERRIDE and TAB or SCROLL to the correct LCP and Load (relay). Exercise each relay by manually switching it on and off 3 or 4 times. If possible, listen to hear the relay contacts clicking as they open and close.

LCD888RNG035Sept08

BLUE BOX LT 1404/1408

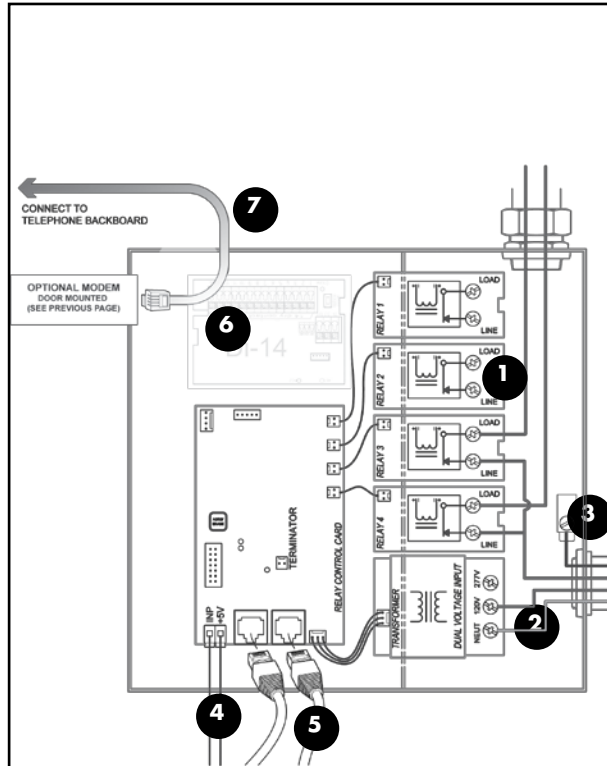

1. 3#18 AWG. Supplies power and neutral from transformer to relay control card.
2. 1-14 conductor ribbon cable: carries control signal between DTC and relay control card (master panel only).
3. 4(1404LT)/ 8 (1408) 2 conductor ribbon cable: carries control signal from smacker strip to relays - one per relay.
4. Terminator / terminator pin-outs. (provided inside master panel) - terminates bus line.

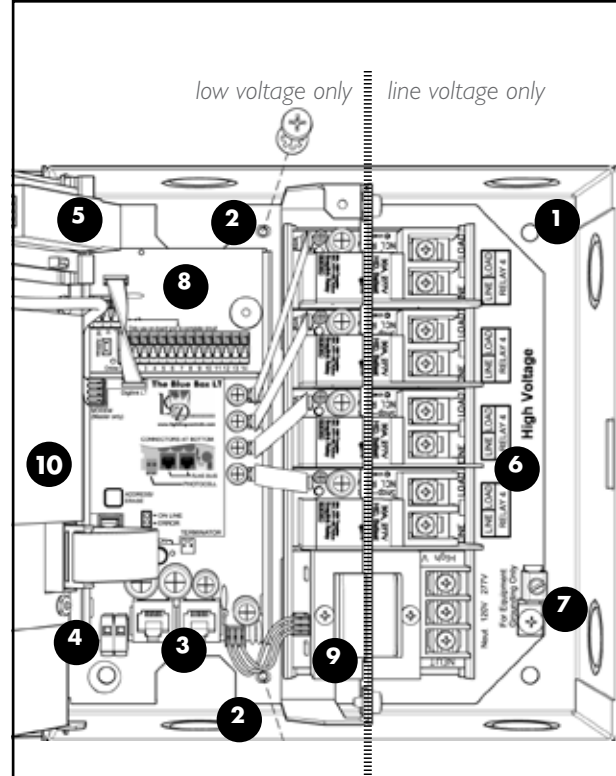

1. Blue Box mounting holes (4).
2. Back plate mounting screws.
3. RJ45 sockets for GR 2400 bus.
4. Photocell input (master only). The Photocell may control any relay(s) in any panel(s).
5. Optional modem. Analog phone line connects to RJ-12 socket.
6. Relays (line and load lugs).
7. Dual-voltage (120V or 277V) power supply.
8. (Optional) Digital Input Card. [DI] 14 (or 6 enable/disable) inputs.
9. Terminator pins. Terminate the bus only after the "System Start-Up and Cabling Guide" has been completed.
10. Clock backplate and back of DTC clock (for the master panel only).

BLUE BOX LT 1416

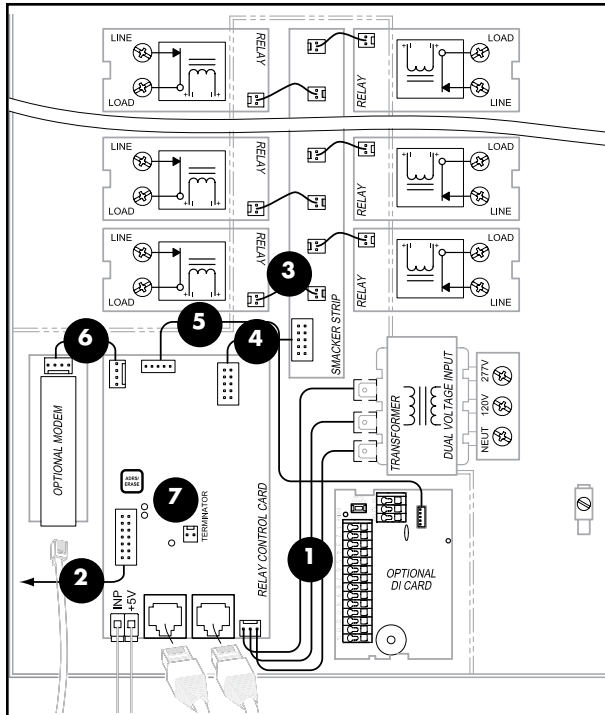

1. 3#18 AWG. Supplies power and neutral from transformer to relay control card.
2. 14 conductor ribbon cable: carries control signal between DTC and relay control card (master panel only).
3. 2 conductor ribbon cable: carries control signal from smacker strip to relays - one per relay.
4. P10 conductor ribbon cable: carries digital signal from relay control card to smacker strip
5. 5 conductor ribbon cable: carries digital signal from relay control card to (optional) digital input card
6. 4#22AWG carries rs-232 signal from (optional) modem to relay control card (master panel only) Dual-voltage (120V or 277V)power supply.
7. Terminator / terminator pin-outs. (provided inside master panel) - terminates bus line.

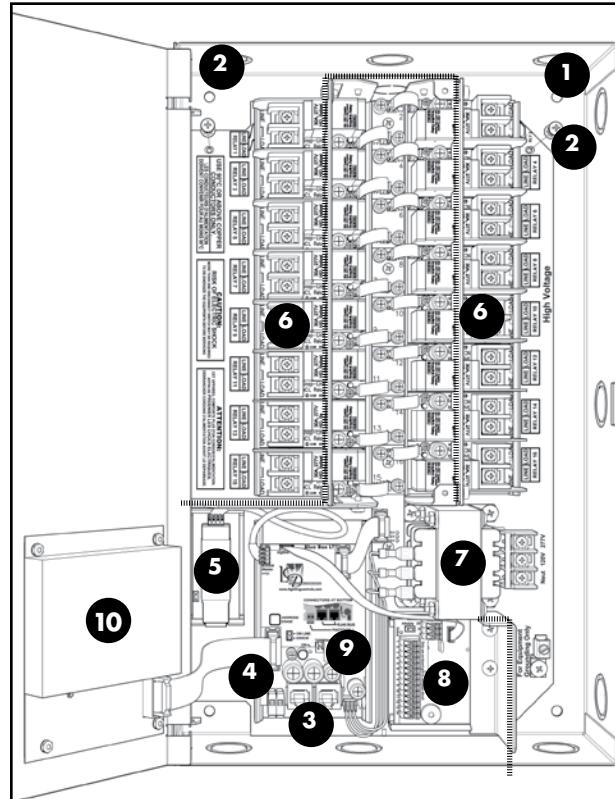

1. Blue Box mounting holes (4).
2. Back plate mounting screws. (Retaining pin located at bottom, lift up and out to remove)
3. RJ45 sockets for GR 2400 bus.
4. Photocell input (master only).The Photocell may control any relay(s) in any panel(s).
5. Optional modem. Analog phone line connects to RJ-12 socket.
6. Relays (line and load lugs).
7. Dual-voltage (120V or 277V)power supply.
8. (Optional) Digital Input Card. [DI] 14 (or 6 enable/disable) inputs.
9. Terminator pins.Terminate the bus only after the "System Start-Up and Cabling Guide" has been completed.
10. Clock backplate and back of DTC clock (for the master panel only).

LCD88RNG03Sept08

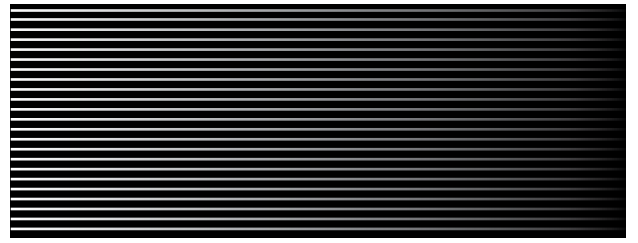
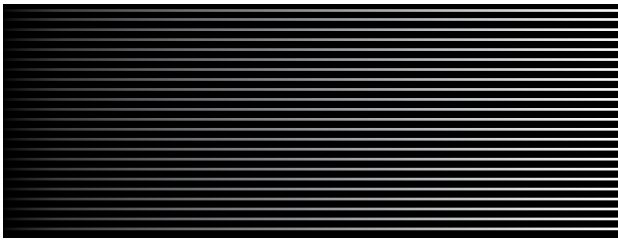

BLUE BOX™ LT

HARDWARE

TROUBLESHOOTING

LCD88HT503sept08



Lighting Control & Design
905 Allen Ave, Glendale CA 91201
Tel: 800-345-4448 • www.lightingcontrols.com

HARDWARE TROUBLESHOOTING

RELAY TROUBLESHOOTING

This section contains the most common problems, causes and solutions for troubleshooting relays. These specific issues will be covered in depth:

- Relay(s) stuck open / stuck closed
- Light turns OFF by itself after a certain period of time
- Light turns ON by itself after a certain period of time
- Relay(s) chattering

PROBLEM: Relay(s) not working:

Relay may be stuck to its previous state and need to be cycled

- Go to “Manual Override” screen
- Try to cycle the relay ON/OFF
- If successful, the physical relay status and the on-screen status indicator will change, in addition the relay should start clicking

QUESTION:

Is the relay “Stuck Open”?

Stuck Open – Lights are constantly OFF, no continuity across the relay when you measure across line & load, and no voltage going to the load side of the relay

- a) Check the circuit breaker:
 - Verify the breaker is set to the ON position
 - If necessary, measure voltage on Line Side of relay.
- b) Next, find out what type of relay it is:
 - “Normally Open Relay”
 - “Normally Closed Relay”
- c) If the relay is “Stuck Open” and it is a Normally Closed Relay (relays are defaulted to the “Normally Closed” position):
 - Unplug the relay jumper to cut the power of the relay and it should go to its failed state
 - The relay is “Normally Closed” so it should fail closed
 - The red LED on the relay should be OFF
 - There should be continuity if you measured across the relay. There should be voltage going to the load side

Is the relay “Stuck Closed”?

Stuck Closed – Lights are constantly ON, there’s continuity across the relay when you measure across line & load, and there’s voltage (120/277) going to the load side of the relay

- a) If the relay is “Stuck Closed” and it is a Normally Open Relay:
 - Unplug the relay jumper to cut the power to the relay; if the relay is “Normally Open” it should go to its fail state, it should fail open.
 - The red LED on the relay should be OFF, if not

Troubleshooting to check:

...If the relay is bad:

- Swap relay with a known working relay or use a spare
- Then cycle the relay ON & OFF
- If spare relay works, the relay may be bad; contact LC&D Technical Support for a replacement.
- If not, there is a possible loose ribbon cable.
 - i. Unplug, then plug the ribbon cable back
 - ii. Cycle the relays ON & OFF

...If the Relay Jumper is bad:

- Change the relay jumper cable by using the jumper cable from a known working relay
- Cycle the relay ON & OFF
- If not fixed, the relay jumper cable is bad; contact LC&D Technical Support for a replacement.

...If the Ribbon Cable is bad:

- Change ribbon cable using a cable from another panel if available
- Then cycle the relay ON & OFF
- If not fixed, this is a bad Ribbon Cable; contact LC&D Technical Support for a replacement.

...If the Smacker Strip is bad:

- Change the smacker strip using a known working smacker strip
- Cycle the relay ON & OFF

HARDWARE TROUBLESHOOTING (Continued)

- If not fixed, this is a bad smacker strip; contact LC&D for a replacement.

...If the relay is in Timer Mode:

- Go to “Manual Override Screen.”
- The status indicator on the screen will have an extra leg, if the relay is in timer mode.
- If not in relay timer mode, the relay may be in a Maintain + Timer or Maintain + Blink Group
- Find out if and which Group controls that relay.
- Go to the “What and When” menu or refer to the system Bus file.
- If the relay is not supposed to be on a Maintain + Timer or Maintain + Blink Group, remove it from Group.

...If the relay(s) are chattering it may be caused by insufficient voltage driving the relay:

- Check for any loose connections with the relay jumpers or the ribbon cable.
- Unplug, and then plug the relay jumper cable back.

SMACKER STRIP TROUBLESHOOTING

If relays do not turn ON or OFF and the relay troubleshooting procedure does not help resolve a relay related issue, follow the steps below:

1. Check the voltage between the smacker strip relay driver pins (24V and Gnd) for the relay in question:
For Normally Closed Relays
If 24V and LED on relay button is OFF
For Normally Open Relays
If 24V and LED on relay button is ON
2. If correct voltage is present, connect a different relay to the driver pins and exercise relay – listen for a clicking sound.
3. If 24V ac is not present on the pins, check other pins for voltage. If no relay driver has 24V ac, disconnect power cable at the bottom of the strip and reconnect. Measure voltage on each driver pin. If no voltage is present, refer to the transformer troubleshooting procedure.

4. If voltage is present on all pins except for the one that controls the relay in question, relay driver is bad and smacker strip will need to be replaced.
5. If voltage is present on all pins, transformer is supplying correct voltage on the secondary side, and power to smacker strip has been reset, disconnect the control card power cable, then disconnect smacker strip power cable, and then the relay jumper. Reconnect control card power cable first, then smacker strip power cable, and finally the relay jumper. Exercise relay and listen for clicking sound. Repeat Step 2. If relay does not respond, replace smacker strip.
6. If replacing the Smacker Strip does not work, the problem lies on the card; contact LC&D for a replacement.

CONTROL CARD TROUBLESHOOTING

Check to see if the “Online” LED is ON.

If “Online” LED is ON (blinking or solid):

1. Navigate to the “Read Address” screen. Read the address.
2. Screen should display either an address or a “0” address.
3. If the screen displays an address:

Use the “Scan by Serial Number” screen, to check if any address collisions exist with another device on the bus.

If collision exists, re-address card to an unassigned address and define it in the “Bus Map”.

If no collision exists, but the card was already assigned to an address in a previous location (where it was causing a collision with another device) on the bus map, eliminate device from bus map and define the correct device on that address.

4. If the screen displays a “0”

Address the card through the “AUTO-ADDRESSING” screen and define it in the “Bus Map” screen.

If unable to read address:

1. Remove the control card from the bus (disconnect all Cat.5),
 - Connect directly to the master control card with a LAN tested cable
 - Read the address of the card through the read address screen

HARDWARE TROUBLESHOOTING (Continued)

2. If address is displayed, a problem exists somewhere along the bus.
 - Troubleshoot the bus using the “Bus splitting technique” for a powered bus – refer to the “System Diagnostics Tools” section of the O&M
 - If a “0” is displayed, address the card using the “AUTO-ADDRESSING” screen and define it in the “Bus Map” screen
3. If unable to read the address, power cycle the card and read address again.
 - If address is displayed, a problem exists somewhere along the bus
 - If a “0” is displayed, address the card through the “AUTO-ADDRESSING” screen and define it in the “Bus Map” screen
 - If address is not displayed still, control card needs to be replaced; contact LC&D for a replacement.
7. Replace clock cable with a new one
 - Disconnect clock cable
 - Replace with a new cable and wait a few seconds for display to show up
8. If replacing the clock cable does not fix the problem, DTC needs to be replaced; contact LC&D for a replacement.

If the DTC displays the message: “Upload in Progress,” the clock is either in the middle of a software upgrade or it was interrupted and got stuck. The fix to this problem is to re-upload the DTC software, if this does not correct the problem, the DTC will need to be replaced. Contact LC&D for a replacement.

TRANSFORMER TROUBLESHOOTING

The transformer should have 120/277 V ac on the primary side and the secondary side should have 20V between the two outer terminals and 10V between the center and either outer terminal.

DTC TROUBLESHOOTING

If the DTC shows no display, follow the steps below:

Check for power to the DTC.

4. Vary contrast to the darkest setting.
 - Open low-voltage panel door. On the back of the display clock, the “contrast” dial can be used to vary the display contrast
 - Using a small Phillips screw driver to turn the contrast dial:
 - Clockwise to turn up the contrast
 - Counter-clockwise to turn down the contrast
5. Power cycle the DTC.
 - Disconnect the clock cable on the back side of the clock display that connects to the control card
 - Re-connect cables and wait for a few seconds for the clock display to show up
6. Disconnect master panel from the bus:
 - Disconnect both Cat. 5 cables connected to the master panel and wait for a few seconds
 - If the display shows up, the problem on the bus exists with the Cat. 5 cabling
1. If the voltage on the primary side is not 120/277 Vac,
 - Check to see if the breaker is in the ON position and that there is voltage from the breaker to the transformer
2. If the voltage on the primary side is correct (120/277 Vac) and any of the devices in the panel are not receiving appropriate voltage:
 - Check the voltage on the secondary side terminals
3. If there is a 120/227 Vac supply from the breaker to the transformer, but not sufficient or steady voltage supply on the secondary side:
 - Transformer needs to be replaced; contact LC&D for a replacement.

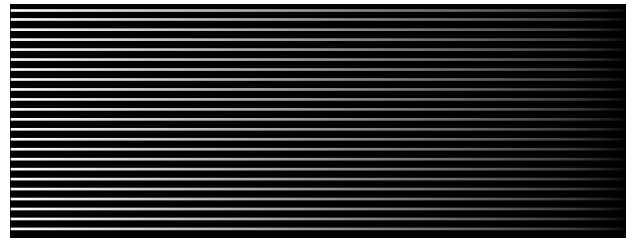
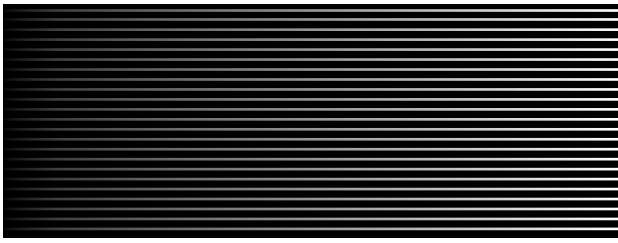

THE BLUE BOX™ LT

TROUBLESHOOTING WITH AN OSCILLOSCOPE

LCD881TSM003Sept08



Lighting Control & Design
905 Allen Ave, Glendale CA 91201
Tel: 800-345-4448 • www.lightingcontrols.com

USING AN OSCILLOSCOPE TO TEST A DIGITAL BUS

In troubleshooting a system or a bus, the “Final Activation Checklist” is always the first and most important step. An Oscilloscope is a visual aid to troubleshoot the bus better:

The Oscilloscope will let one test the stability of the bus while everything is powered up. This will show if the bus is getting noise, how clean the bus signal is, if the bus is properly terminated, if there is a bad device present on the bus, and give an indication of crimp quality.

Below are some examples where the use of an Oscilloscope is definitely needed:

1. The Hardware Activation Tests included the “System Startup and Cabling Guide” passed, but when the system is powered up, devices appear/disappear on the bus scan.
2. The Hardware Activation Tests passed, but some devices don't seem to be working if the bus is connected, and the same devices work perfectly fine when connected directly to a master panel.
3. Everything else was checked (The Hardware Activation Tests” passed and all devices are good) but the bus is still unstable.

HOW TO SETUP THE SCOPE FOR TESTING

Make sure the Oscilloscope is not earth grounded in any way. A battery powered scope is best.

1. Connect the probe leads to the system's A & B terminals; A “Bus Checker Card” may be used to make the testing easier. Attach the alligator clip (which is the ground lead of the probe) to the bus checker card's B terminal, then connect the main probe lead (which is usually a retractable hook tip) to the bus checker card's A terminal.
2. Adjust the vertical & horizontal controls accordingly and set the input coupling to DC. You should be able to see your bus signal which is a “Square Wave Signal.”
3. The advisable setting would be “1.0 volts/div” & “(20 μs to 50 μs) sec/div” this should be able to let one see a decent size waveform on the screen. (10-1 Probe).
4. A completely “Stable Bus” should show a clean & balanced square wave signal. The baseline is centered at “0” and never changes.

5. If the bus is not terminated properly, some “ringing” may be seen. With less loading, the Vpp is higher. If there are not bad devices, the baseline is still at Zero.

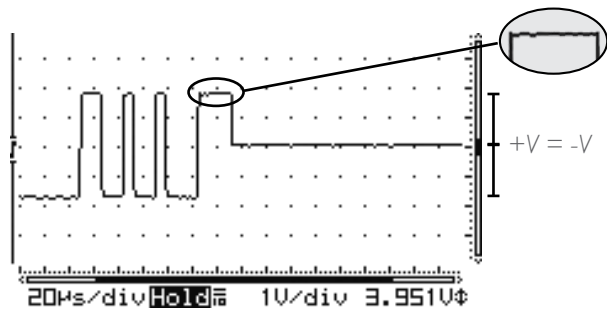
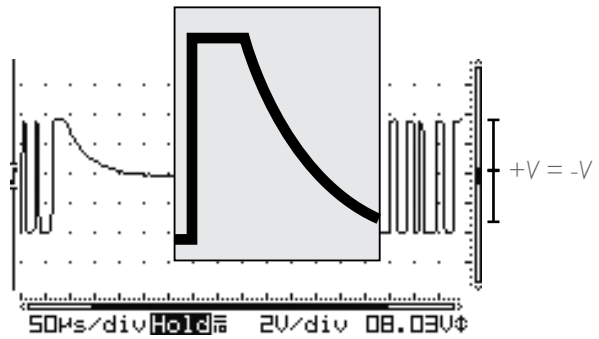

Ideal wave form; Square waves with no ring or dampening means the bus is terminated. +V = -V means no bad devices.

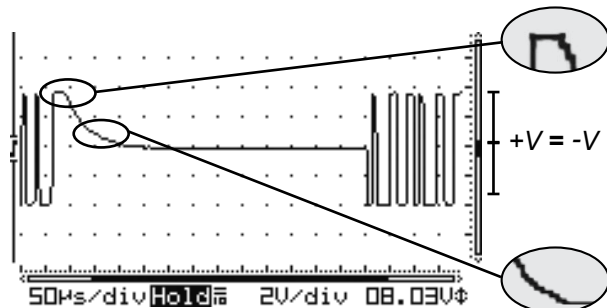

Problematic: Dampened square wave means the bus is missing one or both terminators. +V = -V means no bad devices.

USING AN OSCILLOSCOPE TO TEST A DIGITAL BUS (Continued)

6. With a partially bad device, it is sometimes hard to distinguish because it looks very similar to a good bus. One has to carefully examine the waveform and see if the baseline is centered at Zero.
7. A bad device causes the baseline to shift and become unbalanced. (Baseline is not at Zero anymore). Below are three examples where A & B are not equal.
8. Use the Bus-Splitting technique to find the problem.

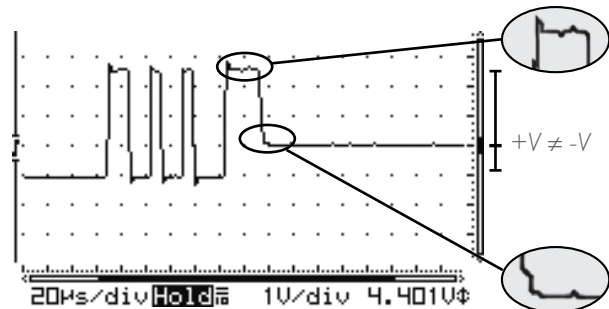

Problematic: Ringing and dampened square wave means that the bus is missing one or both terminators. +V ≠ -V means damaged devices. Usually caused by over-voltage: static, lightning, or line voltage.

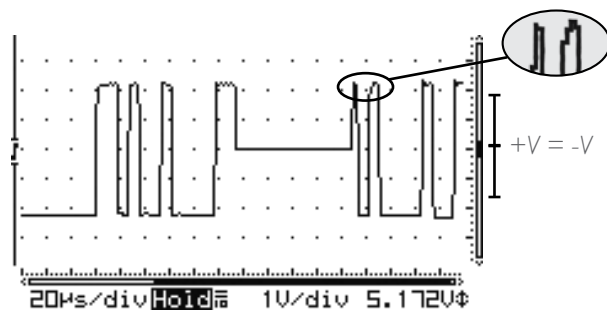

Problematic: Ringing on peak of square wave means the bus is missing one or both terminators. +V = -V means no bad devices.

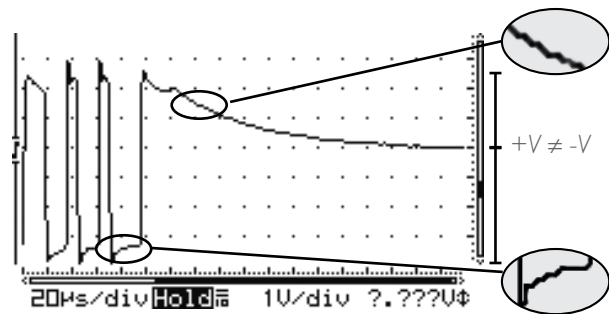

Problematic: Ringing and extremely dampened square wave means the bus is missing one or both terminators. +V ≠ -V means damaged devices. Usually caused by over-voltage: static, lightning, or line voltage.

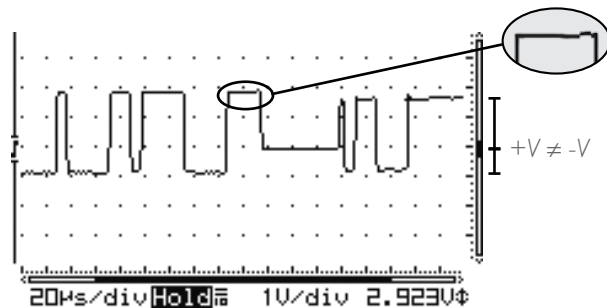

Problematic: Clean square waves mean the bus is terminated. But +V ≠ -V means damaged devices. Usually caused by over-voltage: static, lightning, or line voltage.

BUS SPLITTING TECHNIQUE

! Note: To speed up troubleshooting when readings are less than 200Ω on the Continuity or Short-Circuit test, refer to the “Bus Length Chart” on page 4 before splitting the bus; this can provide an approximate distance to a shorted pair or extra terminator from the test point.

1. On the middle device of the bus, disconnect one Cat. 5 cable to create two smaller “half-buses”.
2. Test each “half-bus” to find the side with the out-of-range values.
3. Repeat steps 1 & 2 on the out-of-range “half-bus,” to create another “half-bus” until the cable, crimp or device creating the out of range measurements is located.

The idea is to split a bus in half and then half again – over and over until the bad area has been located. It is also OK to visually inspect each cable, crimp or device to detect the problem.

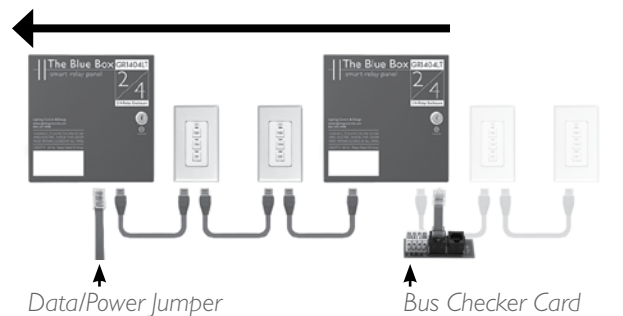
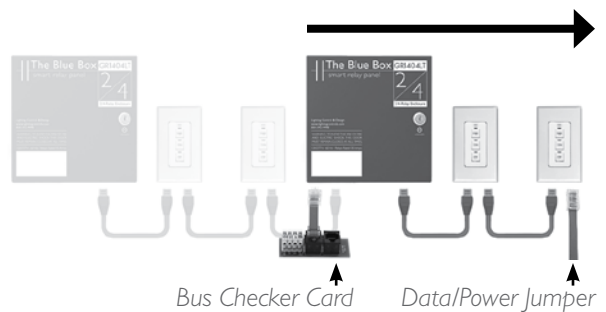
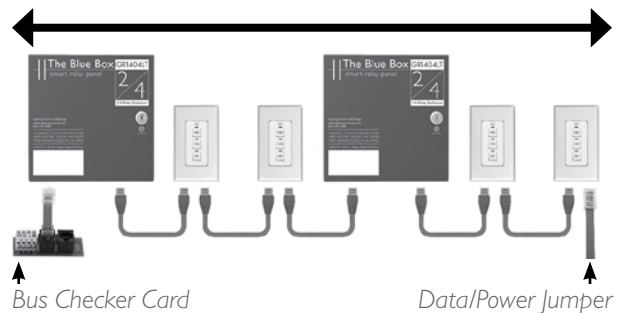

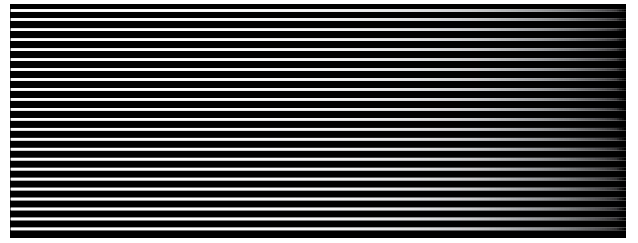
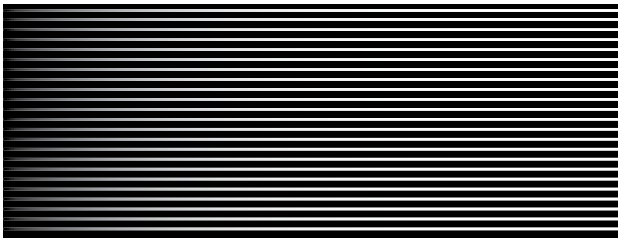

THE BLUE BOX™ LT

PROGRAMMING

LCD88P03Sept08



Lighting Control & Design
905 Allen Ave, Glendale CA 91201
Tel: 800-345-4448 • www.lightingcontrols.com

TABLE OF CONTENTS

Programming	69
DTC Clock Navigation Basics	69
Manual Control of Relays.....	70
Programming Switches or DI Inputs	71
Time Schedules	73
Programming a Blue Box LT Photocell.....	76
To Add a Holiday List to a Schedule.....	77
More Data on Scheduled Events.....	78
Group Types.....	80
Programming Groups	81
Additional Groups Parameters	82
Group FAQs	83
Other System / Set Up Programming	86
Daylight Saving Time	86
Keyboard Lock Code	87
Time Schedule Programming Examples	88
Exercise #1 - Contact Closure Device Controlling 4 Relays	88
Exercise #2 - Contact Closure Device Controlling 10 Relays.....	88
Exercise #3 - Time Schedules with Override Switches	88
Exercise #4 - Retail Store	89

PROGRAMMING

DTC CLOCK NAVIGATION BASICS

Most devices can be programmed from the DTC (Digital Time Clock) in the master LCP (Lighting Control Panel).

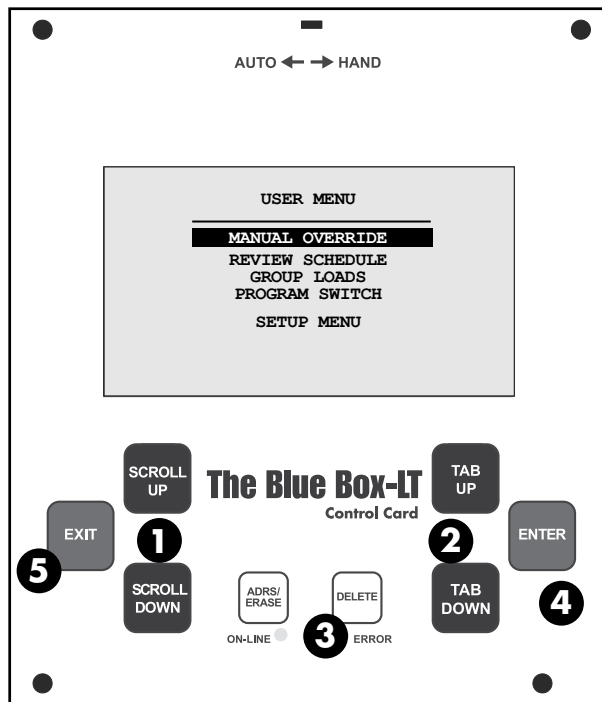

TAB moves the cursor through a screen

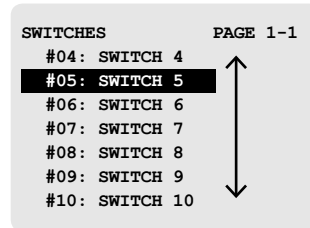

SCROLL to choose one item from a field.*

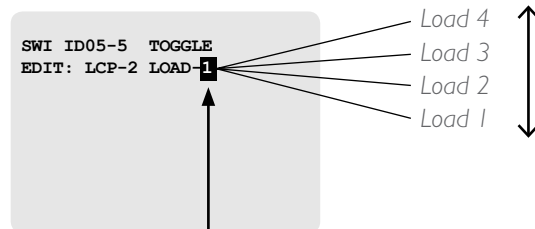

This "field" contains a list of possible selections, but only displays one item from that list at a time.

CALL OUT LEGEND:

1. SCROLL through choices in one field*
2. TAB to position the cursor
3. DELETE information or programming about an item. Use caution.
4. ENTER to select
5. EXIT to leave a screen.

* A "field" contains a list of possible selections, but only displays one item from the list at a time.

MANUAL CONTROL OF RELAYS

Manually control and visually check the (on/off) status of any relays(s) in any panel(s).

To Start

1. TAB once or twice to get started. The USER MENU will display.
2. TAB to MANUAL OVERRIDE.

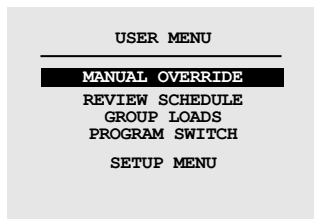

3. ENTER to select the MANUAL CONTROL screen.

To Navigate to a LOAD (Relay)

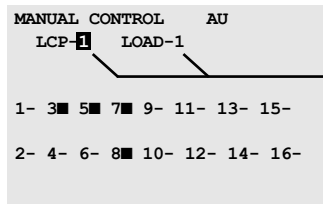

SCROLL to select LCP
 TAB to LOAD
 SCROLL to select LOAD
 ENTER to toggle status

4. TAB to LCP-1 (Lighting Control Panel 1).
5. SCROLL to select the correct LCP (for systems with multiple LCPs).
6. TAB to LOAD-1.
7. SCROLL up or down to select the LOAD (relay) to control.

To Control a LOAD (Relay):

8. ENTER to toggle the status of the LOAD "off" or "on".

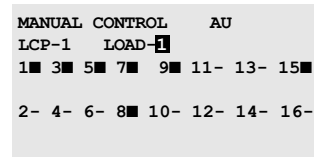

← LOAD 15 is on.
 ← LOAD 16 is off.

- indicates the LOAD is off
- indicates the LOAD is on

There are other relays statuses. Refer to "Groups FAQ" for a more complete description of all of the different relay statuses.

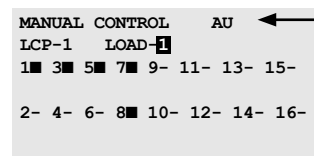

← AU indicates LCP 1 is in AUTOMATIC mode.
 "MN" indicates LCP 1 is in HAND mode

9. Press EXIT several times to get back to the main screen.

PROGRAMMING SWITCHES OR DI INPUTS

To Navigate to Digital Switch or DI Card

1. TAB to start.
2. TAB to PROGRAM SWITCH and ENTER to select.

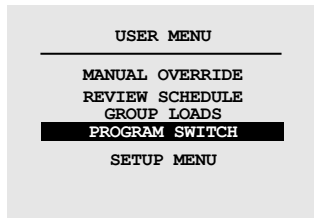

3. If needed SCROLL to the correct Page.

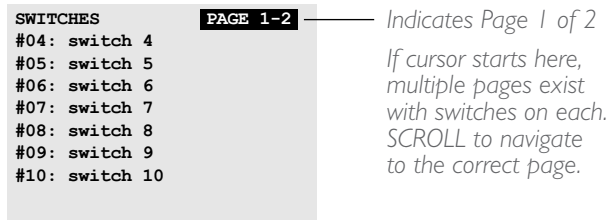

4. TAB to the correct Switch.
5. ENTER to select (Switch 11).

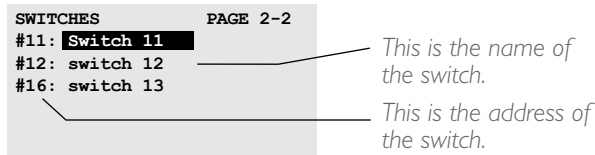

6. TAB to the correct Button/Input.
7. ENTER to select.

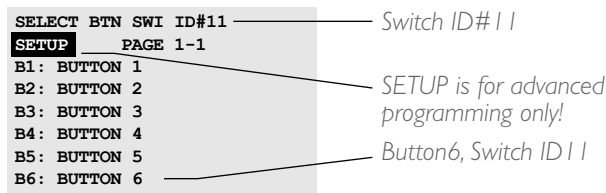

To Select Control Type

Before adding or deleting loads it is important to determine the Control Type (see the Control Types section of this manual).

Tip: Most common Control Types for switches are TOGGLE, ON, and OFF.

1. SCROLL to select Control Type.



Note: Switches may control any number of loads. If more than 8 loads are selected, the system will create a Group upon exiting. When prompted to create a new Group, select "YES" (See Groups Section for more information).

To Add or Delete Loads for all Control Types (except Mixed Mode)

1. TAB to LCP 1.
2. SCROLL to select LCP (1,2,3 etc.).
3. TAB to LOAD 1.

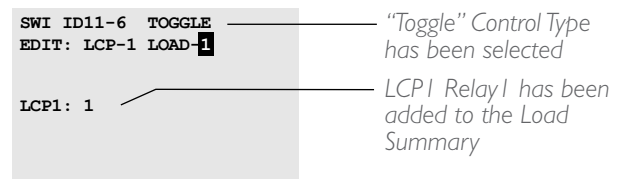

4. SCROLL to the LOAD you want to add or delete.
5. ENTER once to select LOAD - it will be added to the Load Summary.
6. ENTER again to delete LOAD from the Load Summary.
7. Repeat to add or delete more LOADS.
8. EXIT up to main menu.

To Add or Delete Loads for Mixed Mode:

1. SCROLL to select LCP (1,2,3, etc.).
2. TAB to LOAD 1.
3. SCROLL to the LOAD you want to add or delete.
4. ENTER once to add to ON Load Summary.

```
SWI ID13-1 MIXED MODE
EDIT: LCP-2 LOAD-3
```

*Mixed Mode
Load Summary
shows LOADS to be
switched ON and
switched OFF*

```
ON LCP1: 1-3
OFF LCP2: 1-3
```

5. ENTER twice to add to OFF Load Summary.
6. ENTER third time to delete LOAD from Load Summary.
7. Repeat to add or delete more LOADS.
8. EXIT up to main menu.

To Delete a Load:

1. TAB and SCROLL to select LOAD.
2. ENTER until the LOAD is deleted from the Load Summary.

```
SWI ID13-1 TOGGLE
EDIT: LCP-2 LOAD-4
```

```
LCP1: 2-5,12
LCP2: 1,4
```

*Delete LCP2:4 from
Load Summary*

1. TAB to LCP 1
2. SCROLL to LCP 2
3. TAB to LOAD 1
4. SCROLL to LOAD 4
5. ENTER to remove from Load Summary

```
SWI ID13-1 MIXED MODE
EDIT: LCP-2 LOAD-3
```

```
ON LCP1: 1-3
OFF LCP2: 1-3
```

*Delete "LCP1:3" from
"ON" Load Summary*

1. TAB to LOAD 1
2. SCROLL to LOAD 3
5. ENTER until removed from (ON & OFF) Load Summary

Programming an Occupant Sensor

Once the occupant sensor has been connected to the low-voltage dry contact inputs in the DI card, the inputs must be programmed.

Occupant sensor contacts send a "Maintain" type closure to the inputs on the DI card and are therefore programmed as a "Maintain" Control Type (or Maintain Group for more than 8 relays).

To program a DI Input:

1. Navigate to the DI card inputs: USER MENU > PROGRAM SWITCH > SWITCH # > BUTTON #.
2. SCROLL to select MAINTAIN as the Control Type.

```
SWI ID13-1 MAINTAIN
EDIT: LCP-2 LOAD-5
```

```
LCP2: 4,5
```

*Occupant Sensors
use a MAINTAIN
Control Type*

3. Add/delete LOADs (refer to Add or Delete Loads section).

If more than 8 relays are added, accept the creation of a new Group upon EXITing.

To use an existing Group SCROLL to the Control Type and select the Group.

For more information on Control Types, Groups and Group types, refer to the relevant sections in the O&M.

TIME SCHEDULES

Introduction to Time Schedules

There are a few important things to note before programming a Time Schedule:

Time Schedules DO NOT control relays – they control Groups and have Scheduled Events (when things are on and off). Groups contain Loads (relays) and describe “behaviors” pertaining to the schedule. For more information about groups refer to Groups Section.

When creating or modifying a schedule.

1. Scheduled the Events.
2. Add a group which contains loads (relays) and their behaviors.

Example:

Name	What it Controls	Its Behaviors
Schedule 1	Group 1	On 9am Off 5pm Mon-Fri
Group 1	LCP1: relays 1-5 LCP2: relays 3 & 9	When the group is “off”, relays may only be turned on for 2 hours (relay-timer) Prior to shutting lights off, relays issue a blink warning.

To Navigate to Any Schedule (up to 32).

1. TAB to start.
2. TAB to REVIEW SCHEDULE and ENTER to select.

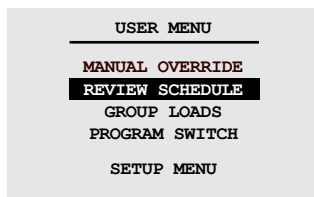

3. A list of the first 6 (of 32) schedules will be displayed. If needed SCROLL to the correct Page

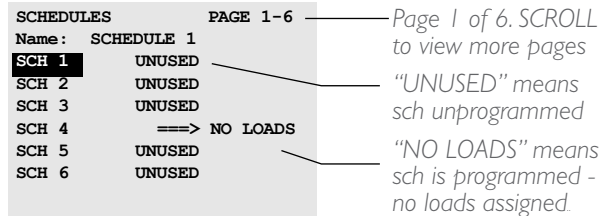

4. TAB to a new or existing SCHEDULE and ENTER to select.
5. TAB to EVERY DAY (default) and SCROLL to select one of three schedule types:
 1. Every Day.
 2. Mon-Fri, Sat Sun.
 3. By Day.

For more information on the three schedule types refer to Scheduled Types Section.

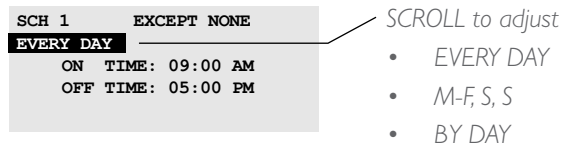

For Every Day or Mon-Fri-Sat-Sun Schedules:

1. TAB to each ON TIME and OFF TIME.
2. SCROLL to adjust the Scheduled Event (refer to “Scheduled Events” Section for more information).

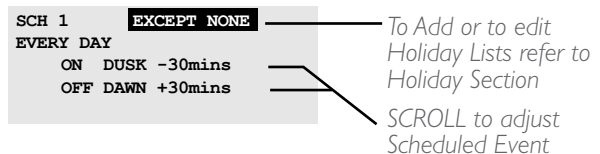

Every Day Schedule - same on & off times 7 days/wk.

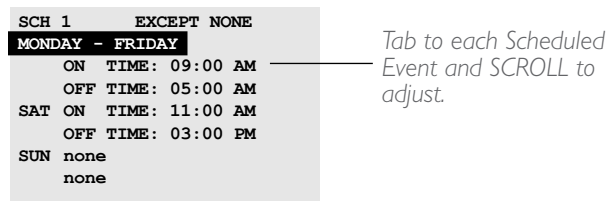

For "By Day" Schedule

With different Scheduled Events for each day of the week, the "BY DAY" schedule offers the most comprehensive feature set of all schedule types.

```
SCH 1
BY DAY      H1 H2
Mo Tu We Th Fr Sa Su
ON TIME:    09:00:00a
OFF TIME:    05:00:00p
from Jan 1 to Dec 31
```

Monday is highlighted

This is the summary of Monday's Scheduled Events

1. Tab to any day and ENTER to edit that day.
2. TAB to ON TIME or OFF TIME and SCROLL to adjust Scheduled Events.

```
ON TIME: 11:30:00 am
OFF TIME: 02:00:00 pm
ADJUST THESE DAYS:
Mon
every day
```

This is the summary of Monday's Scheduled Events in editing mode

To Add Scheduled Events from one day to multiple days ("By Day" schedules only)

3. TAB to Every Day (bottom of screen).
4. SCROLL and ENTER to select the desired day or group of days. Repeat until all desired days are selected. The list of selected days will be displayed (see below).
5. EXIT. Selected days will be updated.

```
ON TIME: 11:30:00 am
OFF TIME: 02:00:00 pm
ADJUST THESE DAYS:
Mon, Tue, Wed
Thu
```

This is a list of more days the Scheduled Events for Monday will be copied to

TAB to here. SCROLL and ENTER to add days to the above list.

6. Repeat steps 1-5 to edit schedules for other days.

To Select a Start-Date and End-Date

1. TAB to JAN and SCROLL to adjust.

2. TAB to I and Scroll to adjust.

3. Repeat as above to edit the end-date.

4. EXIT when complete.

```
SCH 1
BY DAY      H1 H2
Mo Tu We Th Fr Sa Su
ON TIME:    09:00:00a
OFF TIME:    05:00:00p
from Sep 1 to Jun 15
```

Edit Schedule start date and end date here.

Sample Schedules:

```
SCH 1      EXCEPT NONE
MONDAY - FRIDAY
ON dusk -30 mins
OFF TIME: 01:00 am
SAT dusk -30 mins
OFF TIME: 10:00 pm
SUN NONE
NONE
```

These lights will be switched on 30 mins prior to dusk Mon-Sat. Off time on Saturday is earlier (10pm). Lights are off Sunday.

```
SCH 1      EXCEPT NONE
EVERY DAY
ON PCEL: 06:00am
OFF PCEL: 09:00am
```

These two schedules when combined will control outdoor egress and parking lighting before and after hours for employees but only when it is dark out (during the short daylight hours of winter.

```
SCH 2      EXCEPT NONE
EVERY DAY
ON PCEL: 03:00pm
OFF PCEL: 07:00pm
```

These two schedules control lighting at a school in tandem.

```
SCH 8
BY DAY      H1 H2
Mo Tu We Th Fr Sa Su
ON TIME:    07:00:00a
OFF TIME:    07:00:00p
from Sep 1 to Jun 15
```

During the school year (Sept 1 to Jun 15) lights operate on one schedule (SCH 8)

```
SCH 9
BY DAY      H1 H2
Mo Tu We Th Fr Sa Su
ON TIME:    11:00:00a
OFF TIME:    02:00:00p
from jun 16 to aug 31
```

During summer break (Jun 16 to Aug 31), lights operate on a much shorter schedule (SCH 9)

To Add Loads to a Schedule

When you have completed programming a time schedule, the next step is to add the loads to be controlled.

1. To save the schedule press EXIT. TAB to “yes” and ENTER to save the schedule. The clock will take a second to save the changes and exit back to the SCHEDULE LIST menu.
2. TAB to “NO LOADS” and ENTER to add loads to the schedule.

SCHEDULES PAGE 1-6
 Name: SCHEDULE 1
 SCH 1 ==> **NO LOADS**
 SCH 2 ==> UNUSED
 SCH 3 ==> UNUSED
 SCH 4 ==> **GROUP 4**
 SCH 5 ==> UNUSED
 SCH 6 ==> **DISABLED**

Schedule 1 is programmed and has no loads
Schedule 3 is not programmed
Schedule 4 is programmed and controls GROUP 4
Schedule 6 is programmed, but is disabled

3. TAB to MAINTAIN and SCROLL to choose the Group Type.

Quick Tip: Choose MAINTAIN for outdoor lighting and MNTN + BLINK for indoor lighting. For a more complete understanding of Group Types, refer to the Group Section later in this manual.

GROUP1 **MAINTAIN**
 EDIT: LCP-2 LOAD-5
 LCP1:1-5
 LCP2:3,4

Choices are

- MAINTAIN
- MNTN + TIMER
- MNTN + BLINK

4. TAB to LOAD 1.
5. SCROLL to the desired Load (relay) and ENTER to add to the Load Summary.
6. Repeat the TAB and SCROLL sequence and add as many loads as required.

GROUP1 **MAINTAIN**
 EDIT: LCP-2 LOAD- **5**
 LCP1:1-5
 LCP2:3,4

LCP1: 1-5 and LCP 3,4 are in the Load Summary

Additional steps for MAINTAIN + TIMER and MAINTAIN + BLINK Groups

These steps are considered best practice for indoor lighting, and include after-hours relay timers.

MAINTAIN groups can EXIT at this point.

7. With “MNTN + __” highlighted, ENTER to set advanced options.
8. TAB to AUTOMATIC ON. SCROLL to change to NO AUTOMATIC ON if desired. NO AUTOMATIC ON means lighting will not automatically be switched on in the morning by the clock but must be manually switched on by an occupant. This is considered an energy savings feature. AUTOMATIC ON will turn the lights on by the clock, whether occupants are present or not.

GROUP1 PARAMETERS
 AUTOMATIC ON
SET TIMER

9. TAB to SET TIMER and ENTER to program the after-hours relay timers. This feature allows occupants to switch lights on after the scheduled time, but only for a timed duration. This is an energy savings feature and is required by most energy codes.
10. TAB to the Hours/Minutes/Seconds display and TAB/SCROLL to set the Hours/Minutes and Seconds of the after-hours timer. 2:00:00 is usually recommended.

```
TIMER SETTING
REGULAR TIMER MODE
30:59:59 H/M/S
BLINK ONE: 05:00 M/S
BLINK TWO DISABLED
```

After Hours Timer is for all relays in this Group - relays will be in a Timer-Mode to conserve energy
BLINK is only for MNTN+BLINK group

11. TAB to 05:00 and TAB and SCROLL to change the Blink Timer. EXIT twice when complete to return to the Groups screen (Load Summary).
12. EXIT when complete.

PROGRAMMING A BLUE BOX LT PHOTOCCELL

When an outdoor photocell is plugged directly into The Blue Box LT master panel, the photocell is programmed as part of a time schedule (available for schedules 1-8 only).

1. Navigate to: USER MENU>REVIEW SCHEDULE.
2. Use the SCROLL and TAB keys to navigate to the desired schedule. ENTER to select.
3. SCROLL to select schedule type (EVERYDAY, BY DAY, M-F S S).

```
SCH 1 EXCEPT NONE
EVERY DAY
ON TIME: 09:00am
OFF TIME: 05:00pm
```

SCROLL to select schedule type

4. TAB to ON TIME or OFF TIME for each day or group of days and SCROLL to select PCEL.

```
SCH 1 EXCEPT NONE
EVERY DAY
ON PCEL: 09:00am
OFF PCEL: 05:00pm
```

SCROLL to select PCEL

5. TAB to the time settings after ON PCEL and SCROLL to select an "on" time. This is the time that the photocell will be "enabled." When enabled, the group is switched on only if the light levels are below the ON trigger, otherwise they will remain OFF until the light levels drop below the ON trigger.

```
SCH 1 EXCEPT NONE
EVERY DAY
ON PCEL: 03:00pm
OFF PCEL: 05:00pm
```

TAB to hours and minutes and SCROLL to select "on" time

6. TAB to the time settings after OFF PCEL and SCROLL to select an "off" time. This is the time that the photocell will be "disabled" (not allowed to operate). When the photocell is disabled, the group is also switched off.

```
SCH 1 EXCEPT NONE
EVERY DAY
ON PCEL: 03:00pm
OFF PCEL: 10:00pm
```

TAB to hours and minutes and SCROLL to select "off" time

For outdoor lighting, we recommend an "on" time of about 3:00 PM and an "off" time that coincides with the scheduled "off" time.

For daylight harvesting use the PCC3 which offers settings more appropriate for daylight harvesting. (See GR2400 system catalog).

Adjusting Photocell Triggers

7. With the cursor on PCEL, ENTER to edit the trigger settings.

```
SCH 1 EXCEPT NONE
EVERY DAY
ON PCEL: 03:00pm
OFF PCEL: 10:00pm
```

TAB to either PCEL and ENTER to go to trigger settings

8. SCROLL to adjust the "off" Time Delay (10 minutes is usually recommended).

```
On Board Photocell
Reading: 0
Delay to off: 10 mins
Off when light level rises above: 30
Delay to On: 5mins
On when light level falls below: 20
```

In trigger settings you can edit the "on" delay and the "off" delay and the on and off triggers

9. The default setting for the "off" trigger (rises above) is 30. The default setting for the "on"

trigger (falls below) is 20. TAB DOWN to each trigger and and SCROLL to adjust.

```
On Board Photocell
Reading: 0
Delay to off: 10Mins
Off when when light level
rises above: 40
Delay to On:5Mins
On when light level
falls below: 41
```

TAB DOWN to "off" trigger (raises above) and SCROLL to adjust.
ON and OFF triggers should remain at least 10 points apart.

10. TAB to "on" trigger (falls below) and SCROLL to adjust.

```
On Board Photocell
Reading: 0
Delay to off: 10Mins
Off when when light level
rises above: 40
Delay to On:5Mins
On when light level
falls below: 41
```

Tip: A good way to determine the best trigger settings is to do the above steps at a time when daylight about matches when you want the lights to go on or off. For example, set the Off (raises above) trigger in the morning when the sun is just coming up. Check the light level reading on the clock when the area is bright enough for the lights to shut off and use this reading as the "Off" value. Similarly, set the On (falls below) trigger in the evening when it is just getting dark enough so that the lights should come on. Check the light level reading at that time and use it as your "On" value.

11. EXIT and SAVE.

12. To add loads(relays) to this schedule, refer to "Adding Loads to a Schedule". The PCELL schedule is always programmed as MAINTAIN.

```
GROUP 1 MAINTAIN
EDIT: LCP-1 LOAD-5
LCP1:1,2,5
```

Use a MAINTAIN group for photosensor settings.

TO ADD A HOLIDAY LIST TO A SCHEDULE

The system offers up to 2 separate editable Holiday Lists. This portion of the menu allows you to select from pre-existing holiday lists. See Edit/Create Holiday List for instructions on how create or edit a new Holiday List.

Every Day & Mon-Fri, Sat, Sun Schedule

These two schedules only allow the Holiday Lists to be exempt from the schedule.

1. Follow this path: USER MENU > REVIEW SCHEDULE.
2. SCROLL to the correct page and then TAB to the SCHEDULE you wish to add a Holiday List to.
3. In the Schedule, TAB to EXCEPT NONE.

SCH 1
EVERY DAY
ON TIME: 09:00 AM
OFF TIME: 05:00 PM

EXCEPT NONE

Except None
Except H1
Except H2
Except H1 + H2

4. SCROLL to select the desired Holiday Exception.
5. Continue programming this schedule or Exit and Save.

Holiday List in "By Day" Schedule

This schedule allows one or both of the Holiday Lists to be exempt, or even a new schedule created just for the days included in the Holiday List.

1. Follow this path: USER MENU > REVIEW SCHEDULE.
2. SCROLL to the correct page and then TAB to the SCHEDULE you wish to add a Holiday List.

SCH 1
BY DAY H1 H2
Mo Tu We Th Fr Sa Su
ON TIME: 09:00:00a
OFF TIME: 05:00:00p
from Jan 1 to Dec 31

ENTER each Holiday List to edit the Holiday Options

3. TAB to either H1 or H2. – the two Holiday Lists. Both can be selected, but only individually.
4. ENTER to go to the Holiday options menu.
5. SCROLL to select the desired Holiday option. There are three choices:
 - Do Not Omit (default) – the days on this holiday list will be included in this schedule.
 - Omit - the days on this holiday list will not be included in this schedule.
 - ON-OFF schedule - the days on this holiday list will have unique schedules.
6. Program a unique schedule for this Holiday list.
7. Continue programming this schedule or Exit & Save.

To Edit a Holiday List

The Holiday lists contain no Holidays until edited. Two separate holiday lists may be created and edited.

1. Follow this path: USER MENU > SETUP MENU > SYSTEM SETUP MENU > EDIT HOLIDAYS.

```

system setup menu
set time and date
edit HOLIDAYS
system options
what and when?
addressing-bus scan
  
```

```

select holiday list
to edit
HOLIDAY list 1
Holiday list 2
  
```

2. SCROLL to select page.
3. TAB to the Holiday.

```

Holiday list-page 1
Date: Jan1
New Years :yes
ML King :no
Presidents : no
Easter : no
Memorial : no
Independence : no
  
```

```

HOLIDAY LIST 1 - PAGE 3
Jan 1 2008 no
Jan 1 2008: NO
Jan 1 2008: NO
Jan 1 2008: NO
Jan 1 2008: NO
Jan 1 2008: NO
  
```

4. SCROLL to YES to select.
5. To add new Holidays to a Holiday List, SCROLL to page 3 and TAB to the first unused date.
6. TAB to month, day and year and SCROLL to adjust.
7. EXIT when complete.

MORE DATA ON SCHEDULED EVENTS

There are four types of scheduled events, which when combined, offer an almost limitless set of options and capabilities.

“On Time” & “Off Time” Scheduled Events

ON TIME or OFF TIME are also called Time of Day (TOD) events.

To edit an ON or OFF TIME:

1. TAB to the Hours Minutes, (Seconds for BY DAY schedules only) and am/pm settings after ON TIME or and SCROLL to adjust.

```

ON TIME: 09:00 AM
OFF TIME: 05:00 PM
  
```

Astronomical Scheduled Events

The DTC clock offers true astronomical programming. When setting up the clock, the location is entered (by city or Lat/Long) and from that all dusk and dawn times are calculated.

The system even compensates for daylight savings (where applicable).

“DAWN (or DUSK) + or -” means minutes before or after dawn or dusk.

1. TAB to "+ 0 mins".
2. SCROLL up or down to select.

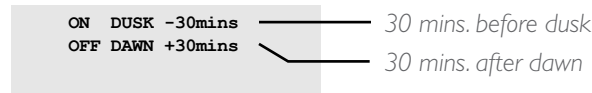

No (NONE) Scheduled Event

In some cases you may desire that nothing at all happen (e.g. no "off time"). In our schedule, this Scheduled Event is referred to as "NONE".

NONE is usually used to disable a specific day or set of days (i.e. Sunday).

1. SCROLL to select NONE.

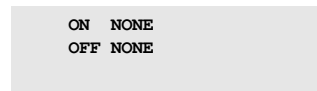

Photocell Scheduled Events

A photocell connected directly to the photocell input of the Master Blue Box LT, controls relays only through any of the first 8 time schedules. Each Schedule may have a unique trigger level, and may be applied to any relay(s) in any panel(s), creating a global photocell.

Refer to "Programming a Blue Box LT Photocell" for programming details.

Mixing Scheduled Events - Custom Schedules

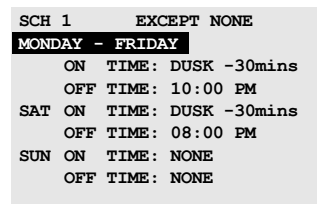

Mix up "on" and "off" events to create a truly unique schedule..

All of the different Scheduled Events (except PCELL) may be mixed with each other to create a variety of scheduling options. If you need help with a particular scheduling requirement, and do not see what you

need here, contact Technical Support, and they will assist you.

Control Types

"Control Types" describes how loads are controlled by schedules, switches, photocells, or DI Cards (via contact closure switches). When controlling more than 8 relays or when any time schedule is used, "Groups" must be used and the Toggle feature is not available.

TOGGLE	A momentary contact will toggle up to 8 loads on or off.
ON MODE	A momentary contact will issue an "on" command to as many as 8 loads.
OFF MODE	A momentary contact will issue an "off" command to as many as 8 loads.
MIXED MODE	A momentary contact will switch one set of loads "on" and another set of loads "off" at the same time.

MAINTAIN	Loads are ON for the duration of a closure and OFF when the closure is opened. Similar to the way a wall switch makes and then breaks a circuit to turn lights on or off. Photosensor Card Triggers are usually programmed as maintain, as is any maintained contact closure device such as a wall switch or a relay closure from (for instance) a security system.
GROUPS (1-32)	To control more than 8 loads, or when programming a time schedule, always use GROUPS.

Last Input Override

Your digital lighting controls use a logic structure called "last input override" and as such, other inputs can affect the loads too. Example: A load is toggled on from one location and then switched off by a

time schedule. If activated again, the toggle switch will turn the loads back on - last input override.

GROUP TYPES

A group describes two things: which relays are controlled together, and how they are controlled. Groups **MUST BE USED** when controlling more than 8 relays and with all time schedules.

Up to 32 groups are available. Any relay(s) in any panel(s) can be assigned to a GROUP.

There are two types of GROUPS:

Maintain Style Groups

Just like the maintain control, starting a maintain contact (or time schedule) will turn a maintain style group on, and when the contact is open or the schedule is off, the group is turned off.

When a Maintain style group is first switched on, the relays within that group are switched on too, with one exception. (See NO AUTOMATIC ON option under Programming Groups).

While the GROUP is “on” the relays within that group will respond normally when switched on and off by a digital wall switch.

The relays are switched off when the GROUPS are switched off, with one exception (see MAINTAIN + BLINK below).

When “Maintain+Timer” or “Maintain+Off Sweep” Groups are off the relays are in “timer mode”: which means if the relays are turned on when the Group is off, they will remain on for a (programmable) timed period. Maintained Groups are used in the following circumstances:

1. Outdoor time schedules usually use a Maintain style group.
2. Indoor time schedules usually use a Maintain+Timer or Maintain+Blink Group which allow relays to be in a “timer mode” when the group is off.

3. When a photocell is connected to a photocell card (not directly to the BLUE BOX panel) and turns more than 8 relays both on and off.

(BASIC) MAINTAIN GROUP	Used by time schedules or for any maintained device (eg. photosensor card triggers) controlling more than 8 loads. When the GROUP is ON the loads are ON, and when the GROUP is OFF, the loads are OFF.
MAINTAIN + TIMER GROUP	Usually used only with Time Schedules. When the GROUP is ON, the loads are ON. When the GROUP is OFF and relays in that GROUP are in Timer Mode, timer duration is programmable. When the GROUP is ON, the relays cannot be in TIMER MODE, when the GROUP is OFF, you can place the relays in TIMER MODE.
MAINTAIN + BLINK GROUP	Works the same as MAINTAIN + TIMER except a “blink” or “flick” warning is issued prior to shutting loads off.

Momentary Style Groups

Any momentary pulse, or any single button press will trigger a momentary group once.

Momentary style groups are used in the following two circumstances to turn relays on or off:

1. When a digital switch, a contact closure, or photocell trigger switches more than 8 relays either “on” or “off” only or;
2. When a time schedule only switches relays either “on” or “off,” but not both. (See table below).

MOMENTARY ON	“On Mode” - any number of loads
MOMENTARY OFF	“Off Mode” - any number of loads
MOMENTARY MIXED	“Mixed Mode” - any number of loads

For more information on groups, please refer to the Groups FAQ.

PROGRAMMING GROUPS

To Access a Group

Within the DTC, there are two paths you can use to access a group for programming purposes:

From USER MENU:

1. Navigate to: USER MENU>GROUP LOADS and ENTER.

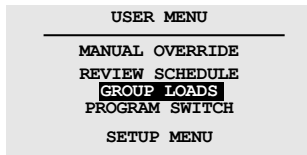

2. SCROLL to the correct page. (1 through 6) and TAB to the desired GROUP. ENTER to begin editing or creating the desired GROUP.

GROUPS	PAGE 1-6		
GROUP 1	UNUSED	OFF	<i>This group does not have any loads</i>
GROUP 2	UNUSED	OFF	
GROUP 3	USED	MOM	<i>Momentary Group</i>
GROUP 4	USED	ON	<i>This Group has loads and is on</i>
GROUP 5	USED	ON	
GROUP 6	UNUSED	OFF	

TAB to a group and SCROLL up or down to change the status. Enter to edit the group

From the SCHEDULE MENU:

SCHEDULES	PAGE 1-6		
Name: SCHEDULE 1			
SCH 1	==>	NO LOADS	<i>Schedule 1 is programmed and has no loads</i>
SCH 2		UNUSED	<i>Schedule 3 is not programmed</i>
SCH 3		UNUSED	
SCH 4	==>	GROUP 4	<i>Schedule 4 is programmed and controls GROUP 4</i>
SCH 5		UNUSED	
SCH 6	==>	DISABLED	<i>Schedule 6 is programmed, but is disabled</i>

After creating, exiting, and saving a schedule, TAB DOWN once to NO LOADS, or GROUP X (X represents a number 1-32). ENTER to edit or create the GROUP.

To Edit a Group

1. SCROLL to select the desired GROUP Type.

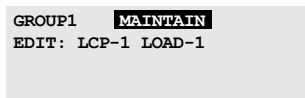

3. Add or delete loads.
4. EXIT when complete.

ADDITIONAL GROUPS PARAMETERS

To adjust Group Parameters such as Automatic On, Group Timer, and Blink Warning, navigate to the Group Parameters Screen:

1. USER MENU > GROUP LOADS.
2. SCROLL to the correct page and TAB select a Group to be edited).
3. TAB to MNTN + TIMER or MNTN + BLINK and ENTER to Group Parameters Screen.

or
TAB to MAINTAIN and SCROLL to MNTN + TIMER or MNTN + BLINK and ENTER to Group Parameters Screen.

Automatic On/No Automatic On

AUTOMATIC ON (the default setting) means that the Group will switch its relays on when the Group is turned on. Example: Schedule 1 turns on Group 1 at 9:00AM. If AUTOMATIC ON is selected the relays in Group 1 will all be switched on. AUTOMATIC ON is recommended for large open areas, such as a sales floor or open area office.

NO AUTOMATIC ON means that the group will not automatically switch relays on when the group is turned on. Example: Schedule 1 turns on Group 1 at 9:00AM. If NO AUTOMATIC ON is selected. the relays in Group 1 will not be automatically switched on. Instead relays are turned on by a local digital control station. NO AUTOMATIC ON is recommended for smaller offices which have local digital control stations.

1. TAB to AUTOMATIC ON.
2. SCROLL to change to NO AUTOMATIC ON.

Relay/Group Timers

All relays in a Maintain + Timer or Maintained + Blink group have an “after-hours” timer value when the group is switched off (usually by a time schedule) the timer duration can be adjusted.

3. TAB to MNTN + TIMER, and ENTER.

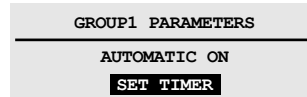

4. TAB to SET TIMER and ENTER to program the after-hours relay timers. This feature allows occupants to switch lights on if the Group is off, but only for the timer duration. This is an energy savings feature required by most energy codes.
5. TAB to the Hours/Minutes/Seconds display and TAB/SCROLL to set the Hours/Minutes and Seconds of the after-hours timer. 2:00:00 is usually recommended. This will determine how long relays are allowed to be “overridden” to the “on” state before the timer runs out.

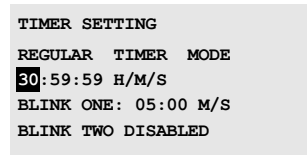

“Blink Timer” is only displayed, in a Maintain+ Blink Group. The default setting of 5 minutes gives occupants 5 minutes after a “blink” warning to activate an override (Momentary On, Toggle, or Momentary On) switch before lights are shut off.

If during that 5 minute period, an “on” button is pressed, all relays controlled by that button will be extended for the duration of the timer (02:00:00 for example), and will again blink at that end of that period. This process repeats itself every time the override switch is activated until the next scheduled On Time.

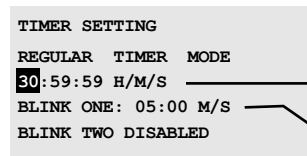

*After Hours Timer is for all relays in this Group - relays will be in a Timer-Mode to conserve energy
BLINK is only for MNTN+BLINK group*

- 6. TAB to 05:00 and TAB and SCROLL to change the Blink Timer to select a new countdown. If a double blink is desired, set the second timer.

Programming Tip: Blink timers work backwards from the off time. So if the first blink is 05:00, and the second blink is 04:55. Then the first blink will be issued 5 minutes prior to shut off and the second blink will be issued 5 seconds later.

- 7. EXIT twice when complete to return to the Groups screen (Load Summary).

```
TIMER SETTING
REGULAR TIMER MODE
02:00:00 H/M/S
BLINK ONE: 05:00 M/S
BLINK TWO: 04:55 M/S
```

GROUP FAQS

Q: How do you manually turn on a group using the clock interface?

A: Go to the "Group Loads" screen, highlight the group:

1. For a MOMENTARY ON group SCROLL UP to turn the relays in that group on,
2. For a MOMENTARY OFF group SCROLL UP to turn the relays in that group off,
3. For a MOMENTARY MIXED group SCROLL UP to control the relays per the ON and OFF programming within that group,
4. For any MAINTAIN group, SCROLL UP to turn the group on and SCROLL DOWN to turn the group off.

Q: How do you tell if a relay has a timer and what timer value is on it?

A: If you check the relay properties screen for that relay, it will say REGULAR TIMER MODE: followed by a number, e.g. TIMER 00:20:00 H/M/S.

Q: How do you tell if a relay timer is active?

A: If the relay is on, the manual override screen will show the normal ON square symbol with an additional little "leg" on the bottom left corner, like this:

Relay ON with no TIMER: 

Relay ON in TIMER mode: 

Q: What does a MAINTAIN + BLINK group do?

A: It is identical to a MAINTAIN + TIMER group, with the only addition being that when you turn a MAINTAIN + BLINK group OFF, the lights will blink or flick, and then wait for a specified amount of time before the relay turns off. This time period is called the "Blink time out." This time period is set in the MAINTAIN + BLINK group under "SET TIMER".

Q: How do you take a relay out of timer mode?

A: Find out what MAINTAIN + TIMER or MAINTAIN + BLINK group that relay is in, and turn that group ON.

Q: How can you tell if a relay has a "Blink Timer"?

A: If you check the relay properties screen for that relay, it will say BLINK One or BLINK Two: followed by a number, e.g. BLINK One: 20:00 M/S.

Q: How can you tell if a relay is in a blink warning time-out?

A: The manual override screen will show the relay as being on with TWO little legs on the bottom corners, as shown here:

Relay on with no BLINK or TIMER: 

Relay in final BLINK Warning Timer: 

Q: What is the purpose of the "Blink time OUT"?

A: It gives the occupants of the area a warning that the lights are about to turn off. They can extend the time that they have light by pushing any button with a rapidly blinking LED. This is the

indication that the lights are in Blink Time OUT.

Q: Where are the two locations on the DTC that a relay timer can be viewed or programmed?

A: USER MENU > GROUP LOADS > TAB to GROUP > ENTER to select >TAB to MAINTAIN+TIMER or MAINTAIN+BLINK >ENTER to select >.

USER MENU >SETUP MENU >SYSTEM RESTRICTED (PASSCODE 900001) >RELAY PROPERTIES >select BOARD >.

Q: You create a new MAINTAIN group or add new relays to an existing MAINTAIN group and EXIT. Upon re-entering the group, you notice it has changed itself into MAINTAIN+TIMER. Why?

A: One or more of the relays in the group are also in another MAINTAIN+TIMER or MAINTAIN+BLINK group which has assigned it or them a timer value. Since the timer value is written into the relay properties, it is carried over into the new MAINTAIN group.

Q: What does MAINTAIN mean in reference to a wall switch?

A: It means that the switch concerned is a contact closure switch like an ordinary wall switch. When one flips the switch UP the contacts close and stay closed and the lights come ON. (They are MAINTAINED that way.) When one flips the switch down the contacts open and the lights go off. Note that both making the circuit and breaking the circuit (from the switch to the contact input) causes the relay(s) to react.

Q: What does MOMENTARY mean in reference to a switch?

A: It means that it is expecting a pulse as would be received from a push button. The command is executed on contact closure. The contact opening does nothing.

Q: How do you find out which group(s) a relay is in?

A: Look in the "What & When Menu": SETUP MENU >SYSTEM SETUP MENU >WHAT AND WHEN? >WHAT CONTROLS RELAYS. Select the relay and press ENTER. Any groups that the relay is in will be displayed.

Q: How do you find out what is turning a group off or on?

A: Look in the "What & When Menu": SETUP >SYSTEM SETUP >WHAT AND WHEN? >WHAT CONTROLS GROUPS. Select the group and press ENTER. Any schedules, photocells or switches that control that group will be displayed.

Q: What do you do to sync up the relays in a group, when some of them are on and some are off?

A: Go to the "group loads" screen and turn on the group again using the SCROLL UP button. If the group is already "ON" scrolling up will re-iterate the "ON" command.

Q: How do you get rid of a group you don't want to use anymore?

A: Go to the "GROUP LOADS" screen, highlight the group and press the DELETE button.

Q: What should you suspect is happening when you delete a group but the relays still have a timer?

A: Those relays are in another MAINTAIN+TIMER or MAINTAIN+BLINK group which is forcing a timer onto them.

Q: What should you be careful never to do with MAINTAIN + TIMER or MAINTAIN + BLINK groups?

A: Never have the same relay in more than one MAINTAIN + TIMER or MAINTAIN + BLINK group.

Q: What does the "NO AUTOMATIC ON" setting in a MAINTAIN+TIMER or MAINTAIN+BLINK

group do?

A: It makes it so that when you turn ON the group, the relays don't come on – only the group status changes to ON and the relay timers are disabled.

Q: Why would someone want to use “NO AUTOMATIC ON”?

A: So they can take disable relay-timers without actually turning the relays on. For example, if the customer wants to turn lights on with a switch early in the morning, and not have them automatically shut off after an hour (timer mode), they would need to turn the MAINTAIN + TIMER group on with a schedule. However, if they don't want the actual lights to turn on until they use a switch, they would set the group to “No Auto On”. This would take the relays out of Timer mode, but not turn them on with the schedule. This saves energy until someone enters the room and switches the lights on.

Q: When must a switch button be programmed to operate a group instead of just operating the relays directly?

A: When you want the switch to operate more than 8 relays, the system will require you to make them into a group.

Q: How do you toggle a group on and off using a single switch button?

A: You can't. Groups cannot be toggled. If you want to turn more than 8 relays on and off with a switch, you need to use two buttons and two groups: one MOMENTARY On and one MOMENTARY OFF.

Q: What kind of group would you normally NOT assign to a momentary switch?

A: You normally do NOT assign any of the maintain-type groups (MAINTAIN, MAINTAIN+TIMER, MAINTAIN+BLINK) to a switch. The reason for

this is that switch buttons turn maintain groups ON when the button is held down and OFF when the button is released.

Having to hold the button down to keep lights on is not generally useful!

Q: If you are having a photocell control more than 8 relays, what type of group would you assign to the photocell?

A: You would normally use a maintain-type group. Remember that only maintain-type groups can be turned on AND off. If you want the photocell to turn lights ON when it is dark and OFF when it is bright, the easiest way is to use a maintain group.

Q: When would you use a momentary-type group with a photocell?

A: When you only want the photocell to turn the relays OFF, or only want it to turn relays ON.

Even when using a schedule to turn the lights off (for example at 11:00pm), one would usually program the Photocell as “Maintain”. This ensures the lights turn off at dawn in the event that an override “ON” command switched the lights on during the night.

OTHER SYSTEM / SET UP PROGRAMMING

Date, Time and Location

The DTC in the relay panel is astronomical, and needs to know the date, time, and location.

```

enter new time/date
8:50:00 AM PAGE 1
 27 June 2008 Fri
Time starts when
you... hit enter
assembled 3 jan 2008
    
```

*To save your settings
TAB to here and
ENTER to select*

1. In the DTC, navigate to: USER MENU > SETUP MENU > SYSTEM SET UP MENU > SET TIME AND DATE.
2. TAB to the hour and SCROLL to select. Repeat this process for minutes, seconds, day, month and year.
3. TAB to "HIT ENTER" and ENTER to save settings.

To Set Location

1. In the DTC Clock navigate to USER MENU > SETUP MENU > SYSTEM SET UP MENU > SYSTEM OPTIONS > SELECT LOCATION > LIST OF CITIES.
2. SCROLL to select city or nearest city.
3. TAB to "HIT ENTER" and ENTER to save settings.

```

Detroit MI
latitude: 42 N
longitude: 83 w
time zone:gmt-5
To accept the above
settings...hit enter
    
```

*SCROLL to select
nearest city*

*To save your settings
TAB to here and
ENTER to select*

Optional: If you cannot find any cities within several hundred miles of your location, EXIT and go to LATITUDE – LONGITUDE. Use a dependable resource (internet, etc.) to locate your exact Latitude and Longitude.

The Time Zone is the number of hours negative or positive from Greenwich Mean Time (GMT). For example: the North American Eastern Time Zone is - 5 GMT, Central Time is - 6, Mountain Time is - 7, Pacific Time is - 8, and Hawaii is - 11.

DAYLIGHT SAVING TIME

The relay control panel will automatically adjust its time setting forward and backward an hour to account for Daylight Saving Time.

To disable Daylight Savings Time

1. Navigate to the Display Options screen: SETUP MENU > SYSTEM SETUP > SYSTEM OPTIONS > DISPLAY OPTIONS.
2. TAB to Daylight Savings and SCROLL to select NO.
3. TAB to "HIT ENTER" and ENTER to save settings.
4. EXIT when complete.

```

Military Time: NO
Seconds Visible: YES
Daylight Savings: YES
Temperature F/C: F
RS-232 K-BAUD: 57.6
Modem mode: 0
Photocell mode: NEW
To save: HIT ENTER
    
```

Daylight Saving Time will now be disabled.

To Adjust Daylight Savings Change-Over dates:

1. Navigate to the Display Options screen: SETUP MENU > SYSTEM SETUP > SYSTEM OPTIONS > DAYLIGHT SET UP.

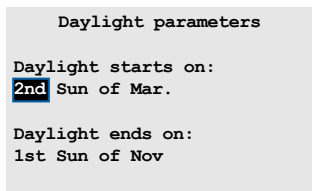

2. TAB to each setting and SCROLL to select the proper value. Note A strict date-time system is not used.

The DTC will set the time forward one hour on the start date and backward one hour on the end date.

3. EXIT when complete. All changes will be automatically saved.

KEYBOARD LOCK CODE

If you are responsible for maintaining and programming the lighting control system, you may wish to prevent others from making changes in the clock interface. To do this, you can set a keyboard lock code that is required to make any changes to schedules, groups, switch programming, etc.

To set up the keyboard lock code, navigate the following menus:

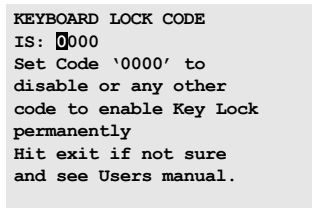

SETUP MENU > SYSTEM SETUP MENU > SYSTEM OPTIONS > KEYBOARD LOCK CODE.

You will be prompted to create a 4-digit keyboard lock code. SCROLL UP or DOWN to change values

and TAB UP or DOWN to move between digits. When the desired value has been entered, EXIT to save the code and return to the previous menu.

Any user attempting to access the programming interface will now be required to enter the code you set in order to view or change settings.

To remove the keyboard lock code, navigate back to the screen where the code was originally.

SETUP MENU > SYSTEM SETUP MENU > SYSTEM OPTIONS > KEYBOARD LOCK CODE (set the 4-digit number to 0000 and EXIT).

TIME SCHEDULE PROGRAMMING EXAMPLES

EXERCISE #1- CONTACT CLOSURE DEVICE CONTROLLING 4 RELAYS

The client wants to have a Security System turn on LCPI: 1-4 for the duration of an "Alarm Mode" event. The Security System will issue a maintained closure for the duration of the event through Input 1 of a contact-closure interface. What do you do?

SOLUTION:

SWITCHES	PAGE 1-2	
#5:	14 BTN SW 5	Address 5 is a 14 Btn Input. Its either the Blue Box contact inputs or a DigLink
#6:	SWITCH 06	
#7:	SWITCH 07	
#8:	SWITCH 08	

SWI ID05-1	MAINTAIN	Select Maintain (refer to Control Types)
EDIT:	LCP-1 LOAD- 4	
LCPI:1-4		Add LCP 1: 1-4

1. Navigate to the DI card address (switch), and the input (button) you want to program (Refer to Navigating to a Switch).
2. TAB to MAINTAIN and SCROLL to select Control Type. Maintain is probably the best choice for a Security System (Refer to Control Types).
3. TAB to LOAD. SCROLL and ENTER to select loads (Refer to Adding a Load).

EXERCISE #2 - CONTACT CLOSURE DEVICE CONTROLLING 10 RELAYS

The same requirements as Exercise #1 but the customer wants the security system to control 10 relays (LCPI 1-10) instead of four.

4. Follow the above steps adding more loads.
5. EXIT when complete.

Your selection is more than 8 loads. Proceed to create a group?	
No / Yes	The system automatically creates a Group more than 8 loads.

6. TAB to YES and ENTER to save as a GROUP.
7. To determine the new Group name. TAB to the button and ENTER.

SWI ID05-1	GROUP 2	Button 1 controls Group 2.
To edit the loads you must use the group menu		

EXERCISE #3 - TIME SCHEDULES WITH OVERRIDE SWITCHES

The client wants a time schedule for indoor lights starting at 7:00 am and off at 5:30 pm.

After hours the digital switches can turn the lights on but only for two hours. Also, the clients want to warn occupants five minutes to prior shut-off. What do you do?

SOLUTION:

1. Set up a schedule: ON: 7:00 AM & OFF: 5:30 PM.

SCH 4	EXCEPT NONE
EVERY DAY	
ON TIME:	07:00 AM
OFF TIME:	05:30 PM

2. The schedule will control a MAINTAIN+BLINK group with a 2 hour timer, and 5 minute blink warning. Select the relays for this group as needed.

SCHEDULES PAGE 1-6	
Name:	SCHEDULE 1
SCH 1	==> GROUP 1
SCH 2	UNUSED
SCH 3	UNUSED
SCH 4	==> NO LOADS
SCH 5	UNUSED
SCH 6	==> DISABLED

GROUP 4	MAINT+BLINK
EDIT:	LCP-1 LOAD-1
LCPI:1-12	

Tip: If you wish to prevent the lights from all coming on at 7:00 am, select NO AUTOMATIC ON, and then the local digital switches will turn the lights on and the schedule will turn the lights off. (see Additional Group Parameters) This is optimal for energy savings when local digital switches are used.

```
GROUP 4 PARAMETERS
NO AUTOMATIC ON
TIMER OUT: 1:00:00 Hr
OFF SWEEP: 05:00 Mins
```

3. Program each switch button that will need to override lighting after-hours with a Toggle or On Mode control type (refer to Control Types) and add loads as appropriate.

```
SWITCHES PAGE 1-2
#5: 14 BTN SW 5
#6: OPEN OFFICE SW1
#7: OPEN OFFICE SW2
#8: RECEPTION
```

Address 6 has been named the OPEN OFFICE SW1.

```
SELECT BTN SW ID#06
PAGE 1-1
B1: BUTTON 1
B2: BUTTON 2
B3: BUTTON 3
B4: BUTTON 4
B5: BUTTON 5
B6: BUTTON 6
```

Refer to Navigation Tree for the Naming Menus

```
SWI ID06-2 ON MODE
EDIT: LCP-1 LOAD-3
LCP1:1,3
```

Select TOGGLE or ON MODE (refer to Control Types)

Add any relays in the group

Tip: Remember, the smaller the zone of control of each button the greater the energy savings.

EXERCISE #4 - RETAIL STORE

Information and customer requirements

1. Store hours: 9:00am to 10:00pm pm every day. Lights should be swept-on 15 minutes before store opening and off 20 minutes after closing.

2. After-hours, all lights (loads) should be on a 1-hour timer with a 5-minute blink warning.
3. Employees enter the store as early as 5:00am and need to switch on enough lights to clean and stock the store (called the "entry level") without the complications of a timer.

Entry level lights are controlled by LCP1:1-7. All remaining lights are controlled by LCP1:8-24

Programming Steps

For step-by-step instruction on how to program these schedules, refer to the sections on adding a load, Control Types, Groups, and time schedules.

1. Set up a Schedule: ON: 5:00 AM & OFF: 10:20 PM. Employees coming in any time after 5:00 AM can switch-on lights manually. The relays will not be in timer mode because the Group was switched on at 5:00 AM with NO AUTOMATIC ON.

Name	Controls	Behaviors
Schedule 4	Group 2 Entry Lights	On 5am Off 10:20pm Every Day
Group 2	LCP1: Relays 1-7	Maintain + Blink NO Automatic On 1 Hour Timer 5 Minute Blink Warn

2. Set up a second schedule: ON: 8:45am & OFF:10:20pm to sweep-on the remaining loads 15 minutes before and 20 minutes after-hours

Name	Controls	Behaviors
Schedule 5	Group 3	On 9:20am Off 10:20pm Every Day
Group 3	LCP1: relays 8-24	Maintain + Blink (Yes) Automatic On 1 Hour Timer 5 Minute Blink Warn

Set-up a third schedule to sweep-on the entry lights, in case they were not manually switched on by a control station. Note that this schedule simulates a momentary push button and only turns the lights on.

Name	Controls	Behaviors
Schedule 6	Group 4	On 8:45am Off 8:46Am Every Day
Group 3	LCPI: relays 1-7	Momentary On

3. Provide a button on a control station that switches on the “entry” lights on the morning (On Mode).
4. Program another button on the same station to allow the last person out to switch off all lights.

SWITCHES PAGE 1-2 #5: 14 BTN SW 5 #6: ENTRY SWITCH #7: SWITCH 07 #8: SWITCH 08	_____ _____ _____	Address 6 has been named the Entry Switch. (Refer to Naming Switches).
SWI ID06-2 ON MODE EDIT: LCP-1 LOAD-8 LCPI:1-8	_____ _____	Select ON MODE (refer to Control Types) Add LCP 1: 1-7

A second control station in the managers office can extend other lighting zones for after hours activities, such as a photo-shoot, or extended store hours.

Tip: Check out our set-back Thermostats. They can be locally and remotely programmed through the Blue Box and can generate a very high Return On Investment.



THE BLUE BOX™ LT

SYSTEM DIAGNOSTICS TOOLS

LCD185SDT03Sept08



Lighting Control & Design
905 Allen Ave, Glendale CA 91201
Tel: 800-345-4448 • www.lightingcontrols.com

SYSTEM DIAGNOSTICS TOOLS

The DTC contains diagnostics tools which detect and help narrow down any bus stability issues.

DIAL UP HOST

To test the operation of a modem, the “Dial up Host” screen may be used to dial out to a cell phone or land line. To do so, navigate to the Dial up Host screen:

USER MENU > SETUP MENU > RESTRICTED (PASS-CODE 900001) > REMOTE SYSTEM MENU > DIAL UP HOST

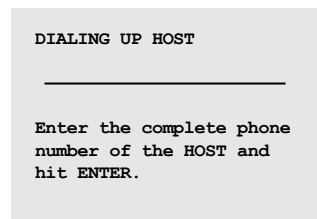

On the screen, SCROLL UP to enter the first digit and TAB DOWN to enter the next number. Enter the area code and the phone number and ENTER to begin dialing out.

ERROR STATISTICS

This screen displays any kind of errors that may be accumulating on the bus. The “overall” errors field is the only one of interest during general troubleshooting.

This screen must be monitored for approximately 3 minutes and if no errors accumulate, the bus is stable.

If errors accumulate in this field, there may be a bus stability issue and the “Bus splitting technique for a powered bus” section at the end of this document may be used to resolve the issue.

The fastest way to detect a bad device, missing, misplaced terminator is to use the “Oscilloscope testing procedure” in the O&M manual.

If an Oscilloscope is not available, complete all the steps in the “System Start-Up & Cabling Guide” and refer to the “Error Check” and troubleshooting sections at the back of the document.

If all tests have passed and errors continue to accumulate, contact Tech Support.

To navigate to this screen:

ERROR STATS.	CLEAR
Overall: 0	
Addr1: 0	
Cmd0: 0	
EEPROM FLAG ERR: 0	
EEPROM WRITE ERR: 0	
DROP-OFF: 0	
FATAL-ERR: 0	

USER MENU > SETUP MENU > RESTRICTED (PASS-CODE 900001) > ADDRESSING-BUS SCAN > ERROR STATISTICS

BUS SCAN

This screen displays all recognized devices on a bus. A relay panel displays the number “3” for every 8 or less relays that it contains, any switch or photocell displays a “1”, and any “Link-to” device such as Link-to-PC card displays a “2”. The Blue Box LT 16 takes up 2 addresses.

If devices seem to appear and disappear intermittently on the bus scan, the bus may be unstable. That is, if a switch is assigned to address 7 and the display shows a “1”, then a “0” and a “1” again, there may be a bad Cat. 5 or device in that area of the bus. To navigate to this screen:

3000000000	0000000000
0000000000	0000000000
0000000000	0000000000
0000000000	0000000000
0000000000	0000000000
0000000000	0000000000
0000000000	0000000000
00000000	0-5 0

USER MENU > SETUP MENU > RESTRICTED (PASS-CODE 900001) > ADDRESSING-BUS SCAN > BUS SCAN DISPLAY

1. To find out which device or devices are appearing or disappearing, count up to the address(es) of the device(s) and note it down.
2. Refer to the “System Device Schedule” in the master panel to find out the device type and location.

The next step would be to follow the Bus Splitting technique for a powered bus.

BUS MAP

Every device must be defined in the DTC under the Bus Map

SYSTEM DIAGNOSTICS TOOLS (Continued)

screen for it to be able to communicate with the rest of the bus. A device may be assigned a "type" through this screen.

If a device takes more than one address, the first address must be used to define the device type and the clock will automatically assign all (consecutive) addresses to the device.

The address assignment on the bus map must always match the Bus Scan display. If they do not, errors will accumulate and devices may not function properly.

If more than one device is assigned the same address, there may be address collisions that may be causing instability.

```

BUS MAP          PAGE 1-19
ID1 : Panel LCP1
ID2 : Panel LCP1
ID3 : UNUSED
ID4 : UNUSED
ID5 : UNUSED
ID6 : UNUSED
ID7 : UNUSED
  
```

To check for collisions, refer to the "Scan by Serial Number" screen. To navigate to this screen:

USER MENU > SETUP MENU > RESTRICTED (PASSCODE 900001) > BUS MAP

SCAN BY SERIAL NUMBER

When starting up the system, one of the steps includes filling out the "System Device Schedule" with the help of this screen. This screen displays the address, device type and serial number of every device on the bus.

Additionally, this screen detects and displays any "overlapping addresses" or "address collisions" for the devices on the bus. If more than one device is assigned the same address, a collision is displayed on this screen.

To view the serial#, device type and address of every device on the bus, highlight "ENTER" and press ENTER.

If any collisions are detected, the screen will display the serial number for any device that is colliding with the device being viewed. One of these devices may then be assigned a different address to eliminate the collision.

To navigate to this screen:

SCAN BY SERIAL#

```

Scanning complete.
Found 3 items.
Not addressed: 0
Hit ENTER when ready.
  
```

USER MENU > SETUP MENU > RESTRICTED (PASSCODE 900001) > ADDRESSING-BUS SCAN > MORE DIAGNOSTICS > DEVICE MANAGEMENT > SCAN BY SERIAL #

BUS SPLITTING TECHNIQUE FOR A POWERED BUS

This method is slightly different from the one in the "Sys-

tem Start-Up & Cabling Guide” in that, we have the added advantage of being able to use the “System Diagnostics Tools” mentioned above to help narrow or track down the problem area.

The Error Checking Screens (Error Statistics and the Bus Scan) must be checked after each of the following steps for accumulating errors and for appearing and disappearing devices respectively.

1. Disconnect both Cat. 5 cables from the Blue Box LT master panel.
2. Add the Cat. 5 from the first device only on either side of the master panel and terminate both devices. Check the Error Statistics and bus scan screen for errors.
3. If errors accumulate on either or both screens, locate the Cat. 5 cable connecting the device that was just added to the bus and check for bad crimps, and conduct a LAN cable test and plug it back in. TAB to “Clear” and monitor both screens for errors for a few minutes. If errors continue to accumulate, replace cable, clear error count, and monitor both screens for errors. If re-testing and replacing cables does not fix the error counts, by-pass the device and add the next device to the master panel.
4. Continue to add devices one at a time while monitoring for errors on both screens until the bad crimp, cable, or device has been detected. Replace, retest cables, or by-pass devices as needed.

```

ERROR STATS.          CLEAR
Overall: 0
Addr1: 0
Cmd0: 0
EEPROM FLAG ERR: 0
EEPROM WRITE ERR: 0
DROP-OFF: 0
FATAL-ERR: 0
    
```



```

3000000000 0000000000
0000000000 0000000000
0000000000 0000000000
0000000000 0000000000
0000000000 0000000000
0000000000 0000000000
0000000000 0000000000
00000000 0-5 0
    
```



```

ERROR STATS.          CLEAR
Overall: 0
Addr1: 0
Cmd0: 0
EEPROM FLAG ERR: 0
EEPROM WRITE ERR: 0
DROP-OFF: 0
FATAL-ERR: 0
    
```



```

ERROR STATS.          CLEAR
Overall: 30
Addr1: 0
Cmd0: 0
EEPROM FLAG ERR: 0
EEPROM WRITE ERR: 0
DROP-OFF: 4
FATAL-ERR: 1
    
```





THE BLUE BOX™ LT

SYSTEM START-UP & CABLING GUIDE

INSTRUCTIONS:

STEP 1:

Install all equipment and note down their serial numbers on the "System Device Schedule" in The Blue Box LT Master Panel.....(Refer to Installation Guides)

STEP 2:

Pull Cat. 5 cable in a daisy-chain between all digital devices. Add "EZ" brand RJ45 connectors to cable ends and crimp using the proper color code. Note: Do not connect contact switches or photocells until Step 5.....Pg.96-97

STEP 3:

Test each cable with a LAN tester and once passed plug each in. Do not power-up devices until Step 6!Pg.97

STEP 4:

Verify proper connections and cabling using the Hardware Activation Tests.....Pg.98

STEP 5:

Make up low voltage cabling and connections for contact closure devices or photocells. (See Installation Guides)

STEP 6:

Start-up and auto-address the digital bus. Pg.99

Once the 6 steps are completed you can program schedules, switches, and photocells. Need help? Call Tech Support: (800) 345-4448.

Digital Network:

Locate multiple Blue Box LTs and control stations where you need them and then link them all with Cat. 5 cable. One master panel (with a Digital Time Clock) for 16 digital devices. Control stations provide combined manual control and after-hours override.

Note: The photocell is not on the digital bus and should not be connected until Step 5.

Slave Relay Panel



Chelsea Digital Switch



Slave Relay Panel



Outdoor Photocell



Master Relay Panel

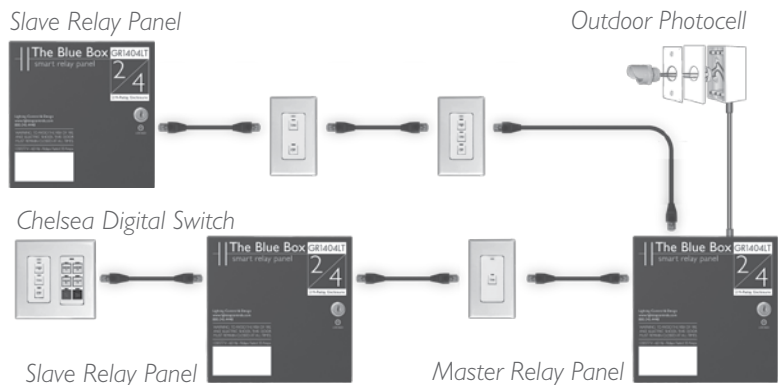

LCD8855U&CG03Sept08

LOW VOLTAGE CABLING

Digital devices have two RJ45 connectors and are daisy-chained using Cat. 5 (see cover). Non-digital devices (photosensors, toggle switches, etc.) are cabled per their installation guides (not daisy-chained).

- ! Adhere to 568A or 568B standards for Cat. 5 cables.
- ! Always use a dedicated pair for the center pins.

Refer to individual product installation guides for line-voltage cabling details and low voltage connection details. Do not "home run" digital switches back to a relay panel. No spurs or T-Taps are allowed. Do not exceed 16 devices on any system with a Blue Box LT Master.

ELIMINATE INTERFERENCE; ISOLATE CAT. 5 CABLES

...From Line Voltage Cable: Cat. 5 cable must be at least 12" from all line voltage conductors, except to cross or make terminations.

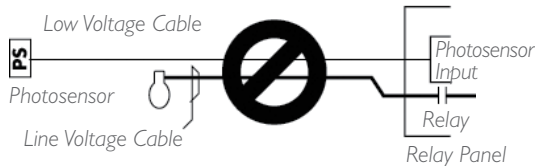

Low voltage cabling must not be run in parallel with line voltage cable, and must not share the same conduit, whether digital cable (Cat. 5) or low voltage cable (3#18 from a photosensor).

...From Line Voltage Devices: Low voltage cabling must avoid EMF or RF from ballasts, arc welders or other "noisy" loads. EMF or RF interference can create an unstable bus.

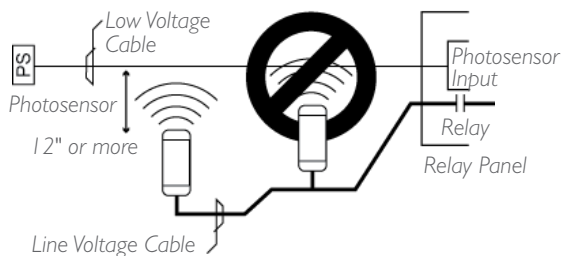

DON'T CAUSE VOLTAGE DROP!

There is a limit to how many switches and photocell cards you can add in a row over long runs of Cat. 5 cabling.

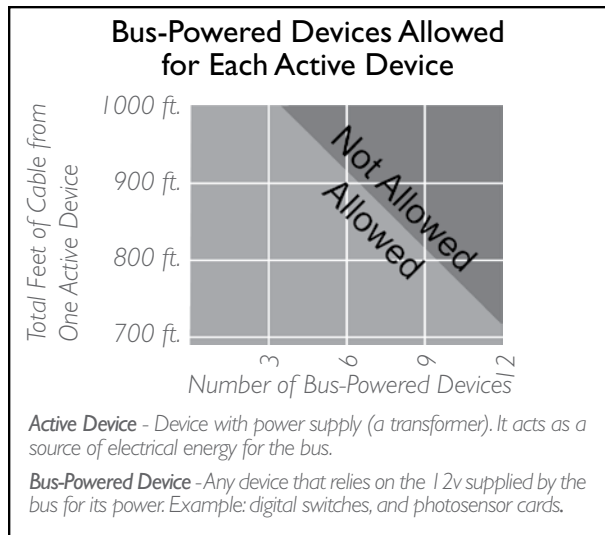

The more feet of Cat. 5 cable used, the fewer bus-powered devices before adding another active device.

Examples: Per the above chart, up to 3 bus-powered devices may be powered across 1,000 feet of Cat. 5 cable.

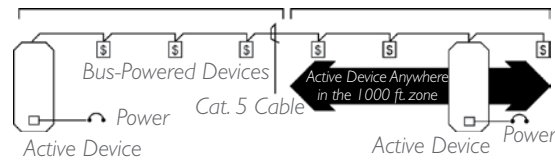

The active device may be located anywhere within the 1,000 foot region.

Multiple active devices in the same location will not increase the distance allowed.

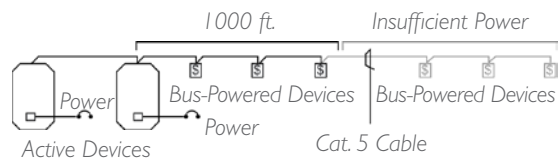

For the above, the correct solution is to connect the active devices (relay panels) as the center of the network and have two runs of cable. Call the Tech Support if cable runs exceed 1000ft without active devices.

MAKING UP RJ45 CONNECTORS

Never made up RJ45 connectors before? Its easy. Just follow the below steps. For a short lesson on making RJ45 connectors, refer to The Blue Box LT "O&M Manual".

To be successful, only use the ratcheting crimping tool recommended by LC&D and a Local Area Network (LAN) cable tester that allows remote testing — the ends of the cable will be remote from each other.

- ! Only use stranded Cat. 5 cable.
- ! Only use EZ RJ45 connectors provided by Lighting Control & Design (LC&D).

1. Remove two inches of the Cat. 5 jacket - use the wire stripper and cutter provided in our kit. Carefully inspect the conductors for nicks.
2. Untwist all four pairs, and straighten/smooth out each conductor.
3. Reorganize the conductors in the order shown in the illustration below. Bring all conductors together until they touch.

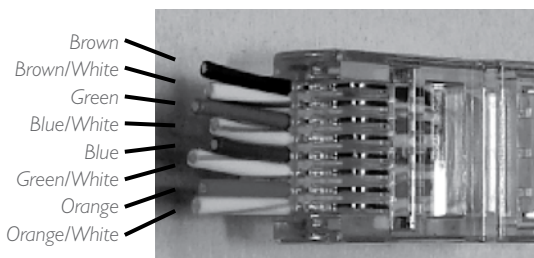

4. Place an EZ connector on the end of the cable with the locking prong facing down.
5. Push conductors completely through and (using flush cutters or box cutters) trim-off all excess cable. Conductors should butt up to the end of the connector — they must not protrude or be too short.

- ! Always follow acceptable safety procedures when using a sharp cutting tool. Tools must be sharp; dull tools cause more hazards than sharp ones.

6. Using the recommended ratcheting crimp tool, crimp at least five times for the best possible connection.



Contacts *not* seated properly (sticking out 1/16 of an inch too far).

7. Visually inspect each connector: Contacts should be pushed into the insulation of each conductor.
8. Repeat on the other end of the cable for a straight-through cable.



Contacts *not* seated properly (bowed crimping).

9. Test every cable for continuity with a LAN cable tester. While testing, wiggle and tug on each connector to test for a solid crimp.

Never make "hot" RJ45 crimps (crimping the other end of a cable that has been plugged into a powered device). This can damage equipment.

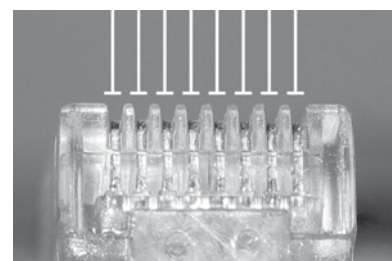

Contacts properly seated (flat crimping).

HARDWARE ACTIVATION TESTS

Before starting, note total approximate bus cable length:

--

Once each cable has been checked with a LAN cable tester and plugged-in, it is still possible for the entire connected cable structure to become problematic. For instance, dirt may accumulate inside the RJ45 sockets, the strain on the Cat. 5 when pushing switches into the wall may weaken connections or even break the conductors, or the bus length may exceed 4000 ft.

Each test must be passed before moving onto the next. If any readings are out of range, refer to "Hardware Activation Troubleshooting" section at the end of this document or call Technical Support at 1-800-345-4448.

CONTINUITY TEST

This test is intended to verify bus length, continuity, and detect crossed data-pair wires.

1. De-power every item on the bus and check the voltage at both ends to ensure a reading of 0vdc. Remove any terminators.
2. At one end of the bus, plug in the "Data/Power Jumper"
3. At the other end of the bus, plug in the "Bus Checker Card" and measure resistance across the following terminals:

Gnd to A	____ohms	B to +12	____ohms
----------	----------	----------	----------

4. All test values must be within 10% of the values in the chart below to be considered valid!

Continuity Test Results (Gnd to A & B to +12)

Length	Ohms	Length	Ohms
100 ft.	3 Ω to 6 Ω	2000 ft.	68 Ω to 80 Ω
500 ft.	12 Ω to 20 Ω	3000 ft.	102 Ω to 120 Ω
1000 ft.	34 Ω to 40 Ω	4000 ft.	130 Ω to 160 Ω

SHORT CIRCUIT TEST

This test is intended to detect any short circuits along the bus. Please use the lowest resistance range (200 Ω) setting on your multi-meter. DO NOT use a "beep" test.

5. Remove the "Data Power Jumper" and measure the resistance across the following terminals on the "Bus

Checker Card,"

6. All test values should be greater than 1K ohm!

Gnd to A	____ohms	A to B	____ohms
Gnd to B	____ohms	A to +12	____ohms
Gnd to +12	____ohms	B to +12	____ohms

EARTH GROUND TEST

This test is intended to detect any pathways to earth ground.

7. Measure resistance between the terminals mentioned below, and "Earth ground" (a metallic enclosure or conduit).

Gnd	A
+12	B

8. All readings between each terminal and "Earth ground" should be infinite or "Open"!

TERMINATOR TEST

This test is intended to ensure that only 2 terminators exist, one at each end of the bus. If the readings are out of range, it would indicate a missing, misplaced, or an extra terminator (terminators are shipped in the Master Panel).

9. Add a "Terminator" on the first and last device. On the "Bus Checker Card", measure

A to B	____ohms
--------	----------

10. Test reading should be within 62 Ω to 92 Ω!

11. Remove the bus checker card and call our Tech Support with your results at: 1-800-345-4448 x391.

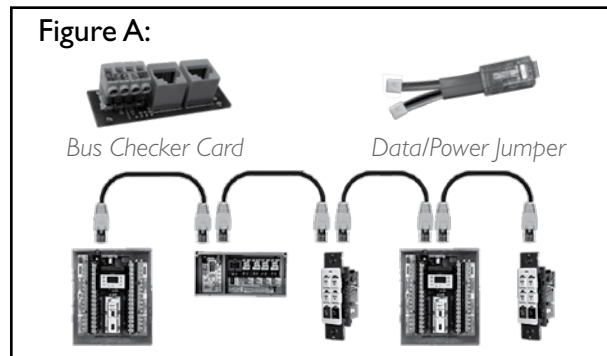

LCD885U8/CO03sept08

SYSTEM ACTIVATION

AUTO ADDRESS DEVICES

Starting up a new system requires a few simple steps. Consider the following steps to set-up and start the system (see page 6 for DTC navigation).

1. After completing the Hardware Activation Tests, power up all slave panels, and active devices (any device with an onboard - 120 or 277 - power supply) first and then power up the master panel. Check that the power-indicator LEDs on all digital devices are lit-up.
2. The main screen will be displayed for a few seconds, after which the "device detection" screen will be displayed. TAB to YES and ENTER to auto-address devices.

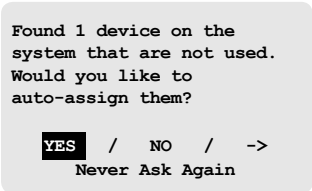

If the number of devices detected do not match the number of devices present on the bus, proceed to trouble-shooting section.

4. To view address assignments in the "Serial Number Scan" screen TAB to YES and ENTER.

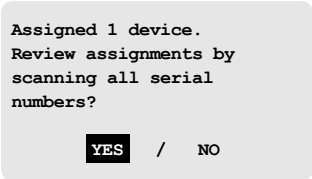

The "Serial Number Scan" screen displays the serial number, address, and device-type of added device(s)

FILL OUT SYSTEM DEVICE SCHEDULE

6. In the "Serial#" field SCROLL to review each device (including DI cards). If collisions are present or if two devices share the same address, contact Tech Support.

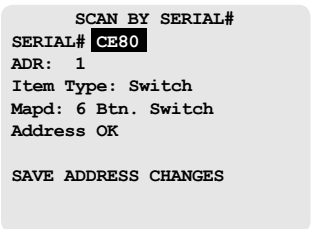

Fill out the "System Device Schedule" located on the back of the "Panel Schedule" inside the master panel.

If unable to correlate the serial numbers and device locations when filling out the "System Device Schedule", refer to the serial label on each device or follow the "Read Address" section of the Blue Box LT "O&M Manual".

SYSTEM DEVICE SCHEDULE: (for Master Panels)

(Master) LCP1 Device Type elec rm Location ce80 Serial # 1 Address	3 btn sw Device Type Hallway Location 8875 Serial # 3 Address	6 btn sw Device Type lobby Location 4685 Serial # 4 Address
DI-6 Device Type LCP 1 Location 4055 Serial # 7 Address	Device Type Location Serial # Address	Device Type Location Serial # Address

ERROR CHECK

The system is now ready for Error Checking. Press EXIT repeatedly to go back to the main menu.

7. Navigate to the "Error Statistics" screen. Use the path USER MENU > SETUP MENU > RESTRICTED > ADDRESSING-BUS SCAN > ERROR STATISTICS. The password to enter the RESTRICTED area is 900001.
8. TAB to the field that says CLEAR and press ENTER to clear errors. If after 3 minutes no errors accumulate on this screen, your system is stable.
9. If errors continue to accumulate refer to the Error Check Troubleshooting section of the Blue Box LT "O&M Manual" or call Technical Support for assistance at 800-345-4448.

VERIFY DATE, TIME & LOCATION

To change the factory programmed settings, refer to the Blue Box LT "O&M Manual".

DIGITAL TIME CLOCK (DTC) NAVIGATION BASICS

DTC CLOCK NAVIGATION BASICS

Most devices can be programmed from the DTC (Digital Time Clock) in the master LCP (Lighting Control Panel).

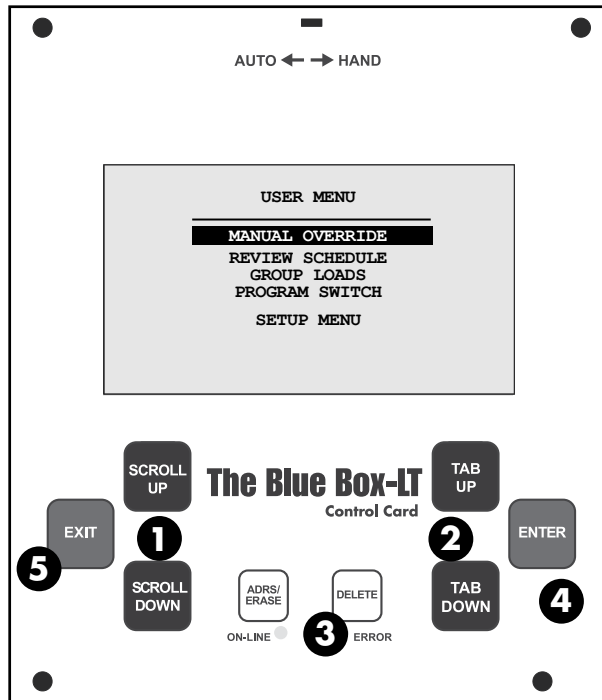

TAB moves the cursor through a screen

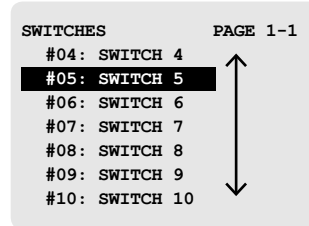

SCROLL to choose one item from a field.*

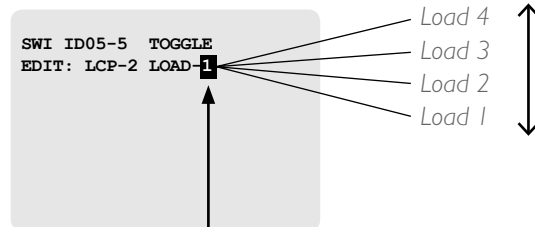

This "field" contains a list of possible selections, but only displays one item from that list at a time.

CALL OUT LEGEND:

1. SCROLL through choices in one field*
2. TAB to position the cursor
3. DELETE information or programming about an item. Use caution.
4. ENTER to select
5. EXIT to leave a screen.

*A "field" contains a list of possible selections, but only displayed one item from the list at a time.

HARDWARE ACTIVATION TROUBLESHOOTING

! Always re-check “failed” results. If improperly set or connected a meter can display unusual readings.

! The “Bus-Splitting Technique” is the fastest way to find a bad cable and/or damaged device. Be sure to document the cable path!

! Cat. 5 cables that pass a LAN cable test can still short or break from stress and strain during installation.

If re-testing a suspected cable, roughly wiggle and tug the conductors near the RJ45 while keeping an eye on the LAN tester: conductors should remain properly engaged throughout the test.

CONTINUITY TEST TROUBLE SHOOTING

1. Fluctuating resistance readings indicate one or more “active” devices are still “hot”. De-power all devices and re-test.
2. High resistance readings indicate broken or resistive connections. Use the “Bus-splitting” technique to find:
 - RJ45 connectors not properly pushed into sockets (check to make sure that the wires are not extended beyond the end of the RJ45 connector)
 - Cable strain can break conductors or pull conductors out of RJ45 contacts (visually inspect cable and connector).
 - Unseated RJ45 sockets (rough install environment)
 - Damaged device (rare)
 - Dirt or paint on RJ45s (rare)
 - Bad data/power jumper cable (rare)

SHORT CIRCUIT TEST TROUBLE SHOOTING

1. A low resistance reading indicates a crossed or shorted pair or (rarely) a damaged device. Cable strain when pushing switches into a wall can short nicked conductors. Use the bus splitting technique to find the bad cable, crimp or device.
2. Resistance readings below 300Ω on A-B only indicate an extra terminator. Use the bus splitting technique to find the short or extra terminator.
3. After the problem has been resolved, please complete the “Continuity Test” again.

EARTH GROUND TROUBLE SHOOTING

LAN-tested cables can still have a path to earth ground.

1. An abraded or “folded” cable inside the conduit will cause a short to earth ground.
2. Other low voltage or high voltage wires touching any device on the bus will cause continuity to earth ground

Use the Bus Splitting Technique to locate the problem.

TERMINATOR TROUBLE-SHOOTING

1. Ensure that the Data/Power Jumper is removed.
2. Visually inspect both terminators are present and properly seated on each bus-end device.

ERROR CHECK TROUBLESHOOTING

If the hardware activation tests have just been completed and the bus is unstable, consider the following causes:

1. Failure to follow the 568A or 568B color code (or minimally to use a dedicated pair for the center pins) will cause the Error Check test to fail. Visually inspect RJ45 connectors.
2. Occasionally, the flat-cable connecting the clock to the master panel can become damaged. Visually inspect the Cat. 5 cable – if damaged, replace it with a new cable.
3. An external source of EMF (electromagnetic frequency) or RF (radio frequency) interference may be present and affecting the bus (or digital devices). Refer to the beginning of this guide on running low voltage cables across or parallel to line voltage cables or exposing low voltage cables to EMF or RF sources (e.g. welders, ballasts, improperly grounded wireless devices, etc.); any of which can interfere with the bus operation and stability.

Visually inspect and handle any external sources of signal noise - a digital device can also become damaged and create signal noise.

An oscilloscope can be used to locate the source of the bus failure. The “Oscilloscope Test” can be found in The Blue Box LT “O&M Manual”.

If unfamiliar with how to use an oscilloscope or if one is unavailable on-site, contact Tech Support: 1-800-345-4448.

HARDWARE ACTIVATION TROUBLESHOOTING (Continued)

BUS SPLITTING TECHNIQUE

! Note: To speed up troubleshooting when readings are less than 200Ω on the Continuity or Short-Circuit test, refer to the "Bus Length Chart" earlier in this document before splitting the bus; this can provide an approximate distance to a shorted pair or extra terminator from the test point.

1. On the middle device of the bus, disconnect one Cat. 5 cable to create two smaller "half-buses".
2. Test each "half-bus" to find the side with the out-of-range values.
3. Repeat steps 1 & 2 on the out-of-range "half-bus," to create another "half-bus" until the cable, crimp or device creating the out of range measurements is located.

The idea is to split a bus in half and then half again – over and over until the bad area has been located. It is OK to visually inspect each cable, crimp or device to detect the problem.

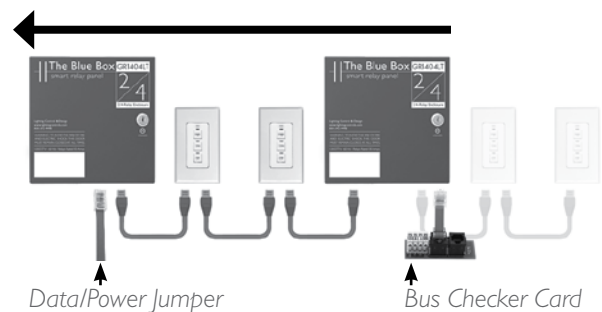
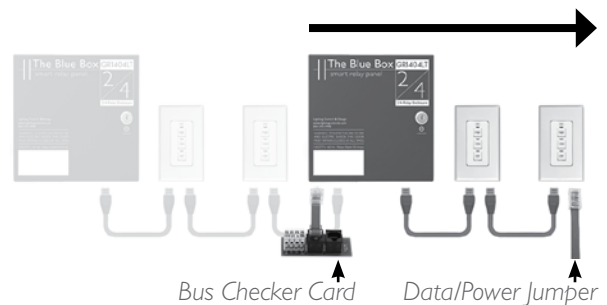
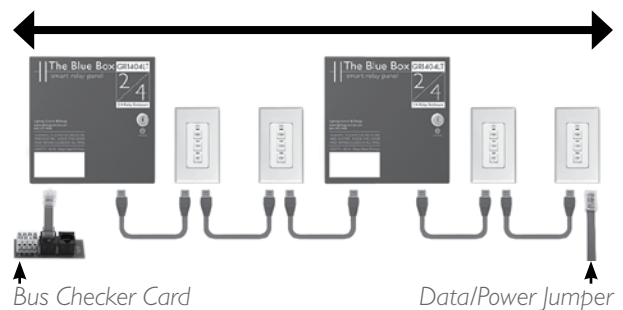

LIGHTING CONTROL & DESIGN

905 Allen Ave • Glendale, CA 91201 • Support 800-345-4448 • www.lightingcontrols.com

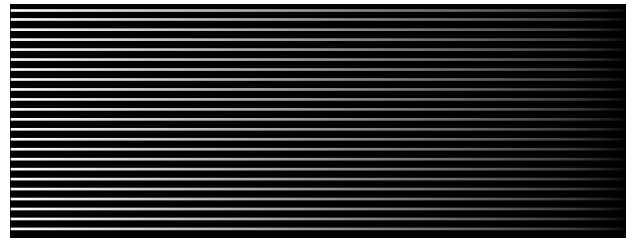
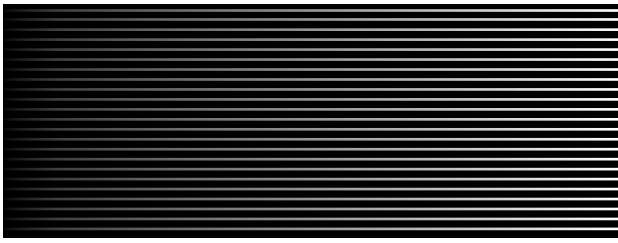

THE BLUE BOX™ LT

FREQUENTLY ASKED QUESTIONS

LCD88FA003Sept08



Lighting Control & Design
905 Allen Ave, Glendale CA 91201
Tel: 800-345-4448 • www.lightingcontrols.com

GENERAL FAQ

- Q: Where is the modem connected?
- A: The modem is connected to The Blue Box™ LT master panel using the 4-wire connector provided with the modem. One end is connected to the modem card on the 4-pin connector and the other end is connected to the 4-pin connector on The Blue Box™ LT card labeled "MODEM".
- Q: How do you change a schedule?
- A: To edit a schedule, navigate to the REVIEW SCHEDULES screen: SETUP MENU > REVIEW SCHEDULES > and highlight the schedule that needs to be modified. Change the ON or OFF times as desired. For more information, refer to the "Time Schedules" section.
- Q: What does the Red LED on the relay indicate?
- A: The Red LED indicates the status of a relay. For Normally Closed relays, the red LED indicates the relays (lights) are OFF. For Normally Open relays, the red LED indicates the relays (lights) are ON.
- Q: What does the ONLINE LED indicate?
- A: The ONLINE LED indicates that the card is functioning normally, but not necessarily recognized by the bus. A solid ONLINE LED indicates that the panel is "stuck", which usually occurs after a power surge, short or storm.
- If ONLINE LED is solid, follow the steps below:
- Disconnect card from the bus by disconnecting all Cat. 5 cables connected to it.
- Power cycle the card by disconnecting power supply cable connected to the power input connector labeled AC Input - located at bottom-right of the card.
- If issue persists after connecting card to the bus, complete the steps in the "System Start-Up and Cabling Guide" to verify Cat. 5 integrity. Contact Tech Support with results.
- Q: How many relays can fit in the Blue Box?
- A: A maximum of 4 relays may be installed in a Blue Box LT 2/4. A maximum of 8 relays may be installed in a Blue Box LT 4/8. A maximum of 16 relays may be installed in a Blue Box LT 8/16.
- Q: How is the Blue Box photocell programmed?
- A: Photocells connected directly to the Blue Box LT master panel may be programmed under any of the first 8 schedules under the REVIEW SCHEDULES screen. To get to this screen, do the following: SETUP MENU > REVIEW SCHEDULES > SCHEDULE # > ENTER on PCELL ON or PCELL OFF. Change settings as desired. Refer to the "Programming a photocell" section.
- Q: Why can't I see the photocell in the bus scan?
- A: A Blue Box LT photocells are not digital devices and do not sit on the bus - the inputs for Blue Box LT photocells are provided on the master panel. Refer to "PCO Installation Guide".
- Q: What is the DI card?
- A: DI cards provide programmable inputs for contact closure devices such as analog switches and occupant sensors.
- Q: How do I adjust the contrast level on the Clock?
- A: The contrast screw is located on the back of the display. Use a small Phillips screwdriver to rotate clockwise for increasing and counter-clockwise for decreasing the contrast level.
- Q: What is the AUTO/HAND switch for and what does it do?
- A: When in AUTO mode, relays can be controlled by the system (schedules, switches, etc.).
- When in HAND mode, all lights will turn ON, i.e. both Normally Closed and Normally Open relays will close. This feature is generally used for maintenance purposes.
- Q: Does the Blue Box LT have to be the first device?
- A: The Blue Box LT, like any digital device, may be placed anywhere along the bus. If unsure how or where to install, refer to the single line drawing in the Blue Box "Installation Guide".

GENERAL FAQ (Continued)





Q: Does The Blue Box LT have an astronomical clock?

A: Yes. The astronomical clock is accessed by scrolling on the "time" field in a schedule. Choose DUSK or DAWN as appropriate.

Q: Can you have a DUSK to DAWN schedule without the photocell?

A: Yes. Refer to the "Time schedules" section to program DUSK to DAWN schedules.

GROUPS FAQ

- Q: What does a “maintain” type group do?
- A: When the MAINTAIN group is turned ON, it turns its relays ON. When it is turned OFF, it turns its relays OFF.
- Q: What does a “momentary” type group do?
- A: Momentary groups are usually used with switch buttons. They can be ON, OFF or mixed.
- Q: What is the difference between “maintain” type groups and “momentary” type groups?
- A: A MAINTAIN group can be turned ON and OFF. Once it is turned ON, it stays on until turned OFF. When it is turned OFF, it stays OFF until turned ON. A MOMENTARY ON group can only turn its relays ON, never OFF. A MOMENTARY OFF group will always turn its relays OFF. A MOMENTARY MIXED group turns some relays ON and some relays OFF.
- Q: Which type of group is most commonly used for schedules and why?
- A: Usually schedules operate “maintain” type groups. This is because schedules are used to turn lights on and have them stay on for a period of time, and then turn them off. Only maintain groups can be turned on and off.
- Q: When would you use a “momentary” type group with a schedule?
- A: In those rare instances when a schedule needs to just turn lights on (without a corresponding off command) or off (without a corresponding on command). For example, if you wanted the lights turned off by a schedule at 8pm every day, but didn’t want any on time, you would create a schedule that activates a Momentary OFF group.
- Q: What does a MAINTAIN + TIMER group do?
- A: When it is turned ON, it turns its relays ON. When it is turned OFF, it turns off its relays AND enables a timer on each relay. If any of the relays in timer mode are flipped on with a switch, etc., they will automatically turn back off again after the timer has expired.
- Q: How do you tell if a relay has a timer and what timer value is on it?
- A: If you check the relay properties screen for that relay, it will say REGULAR TIMER MODE: followed by a number, e.g. TIMER 00:20:00 H/M/S.
- Q: How do you tell if a relay timer is active?
- A: If the relay is on, the manual override screen will show the normal ON square symbol with an additional little “leg” on the bottom left corner, like this:
- Relay ON with no TIMER: 
- Relay ON in TIMER mode: 
- Q: What does a MAINTAIN + BLINK group do?
- A: It is identical to a MAINTAIN + TIMER group, with the only addition being that when you turn a MAINTAIN + BLINK group OFF, the lights will blink or flick, and then wait for a specified amount of time before the relay turns off. This time period is called the “Blink time out.” This time period is set in the MAINTAIN + BLINK group under “SET TIMER”.
- Q: How do you take a relay out of timer mode?
- A: Find out what MAINTAIN + TIMER or MAINTAIN + BLINK group that relay is in, and turn that group ON.
- Q: How can you tell if a relay has a “Blink Timer”?
- A: If you check the relay properties screen for that relay, it will say BLINK One or BLINK Two: followed by a number, e.g. BLINK One: 20:00 M/S.
- Q: How can you tell if a relay is in a blink warning time-out?
- A: The manual override screen will show the relay as being on with TWO little legs on the bottom corners, as shown here:
- Relay on with no BLINK or TIMER: 
- Relay in final BLINK Warning Timer: 
- Q: What is the purpose of the “Blink time OUT”.
- A: It gives the occupants of the area a warning that the lights are about to turn off. They can extend the time

GROUPS FAQ (Continued)

that they have light by pushing any button with a rapidly blinking LED. This is the indication that the lights are in Blink Time OUT.

Q: Where are the two locations on the DTC that a relay timer can be viewed or programmed?

A: USER MENU >GROUP LOADS >TAB to GROUP > ENTER to select >TAB to MAINTAIN+TIMER or MAINTAIN+BLINK >ENTER to select >

USER MENU >SETUP MENU >SYSTEM SETUP MENU >RESTRICTED (PASSCODE 900001) >RELAY PROPERTIES >select BOARD >

Q: You create a new MAINTAIN group or add new relays to an existing MAINTAIN group and EXIT. Upon re-entering the group, you notice it has changed itself into MAINTAIN+TIMER. Why?

A: One or more of the relays in the group are also in another MAINTAIN+TIMER or MAINTAIN+BLINK group which has assigned it or them a timer value. Since the timer value is written into the relay properties, it is carried over into the new MAINTAIN group.

Q: What does MAINTAIN mean in reference to a wall switch?

A: It means that the switch concerned is a contact closure switch like an ordinary wall switch. When one flips the switch UP the contacts close and stay closed and the lights come ON. (They are MAINTAINED that way.) When one flips the switch down the contacts open and the lights go off. Note that both making the circuit and breaking the circuit (from the switch to the contact input) causes the relay(s) to react.

Q: What does MOMENTARY mean in reference to a switch?

A: It means that it is expecting a pulse as would be received from a push button. The command is executed on contact closure. The contact opening does nothing.

Q: How do you find out which group(s) a relay is in?

A: Look in the "What & When Menu": SETUP MENU >SYSTEM SETUP MENU >WHAT AND WHEN?

>WHAT CONTROLS RELAYS. Select the relay and press ENTER. Any groups that the relay is in will be displayed.

Q: How do you find out what is turning a group off or on?

A: Look in the "What & When Menu": SETUP >SYSTEM SETUP >WHAT AND WHEN? >WHAT CONTROLS GROUPS. Select the group and press ENTER. Any schedules, photocells or switches that control that group will be displayed.

Q: How do you manually turn on a group using the clock interface?

A: Go to the "group loads" screen, highlight the group:

1. For a MOMENTARY ON group SCROLL UP to turn the relays in that group on,
2. For a MOMENTARY OFF group SCROLL UP to turn the relays in that group off,
3. For a MOMENTARY MIXED group SCROLL UP to control the relays per the ON and OFF programming within that group,
4. For any MAINTAIN group, SCROLL UP to turn the group on and SCROLL DOWN to turn the group off.

Q: What do you do to synch up the relays in a group, when some of them are on and some are off?

A: Go to the "group loads" screen and turn on the group again using the SCROLL UP button. If the group is already "ON" scrolling up will re-reiterate the "ON" command.

Q: How do you get rid of a group you don't want to use anymore?

A: Go to the "GROUP LOADS" screen, highlight the group and press the DELETE button.

Q: What should you suspect is happening when you delete a group but the relays still have a timer?

A: Those relays are in another MAINTAIN+TIMER or MAINTAIN+BLINK group which is forcing a timer onto them.

- Q: What should you be careful never to do with MAINTAIN + TIMER or MAINTAIN + BLINK groups?
- A: Never have the same relay in more than one MAINTAIN + TIMER or MAINTAIN + BLINK group.
- Q: What does the "NO AUTOMATIC ON" setting in a MAINTAIN+TIMER or MAINTAIN+BLINK group do?
- A: It makes it so that when you turn ON the group, the relays don't come on – only the group status changes to ON and the relay timers are disabled.
- Q: Why would someone want to use "NO AUTOMATIC ON"?
- A: So they can take disable relay-timers without actually turning the relays on. For example, if the customer wants to turn lights on with a switch early in the morning, and not have them automatically shut off after an hour (timer mode), they would need to turn the MAINTAIN + TIMER group on with a schedule. However, if they don't want the actual lights to turn on until they use a switch, they would set the group to "No Auto On". This would take the relays out of Timer mode, but not turn them on with the schedule. This saves energy until someone enters the room and switches the lights on.
- Q: When must a switch button be programmed to operate a group instead of just operating the relays directly?
- A: When you want the switch to operate more than 8 relays, the system will require you to make them into a group.
- Q: How do you toggle a group on and off using a single switch button?
- A: You can't. Groups cannot be toggled. If you want to turn more than 8 relays on and off with a switch, you need to use two buttons and two groups: one MOMENTARY ON and one MOMENTARY OFF.
- Q: What kind of group would you normally NOT assign to a momentary switch?
- A: You normally do NOT assign any of the maintain-type groups (MAINTAIN, MAINTAIN+TIMER, MAINTAIN+BLINK) to a switch. The reason for this is that switch buttons turn maintain groups ON when the button is held down and OFF when the button is released.
- Having to hold the button down to keep lights on is not generally useful!
- Q: If you are having a photocell control more than 8 relays, what type of group would you assign to the photocell?
- A: You would normally use a maintain-type group. Remember that only maintain-type groups can be turned on AND off. If you want the photocell to turn lights ON when it is dark and OFF when it is bright, the easiest way is to use a maintain group.
- Q: When would you use a momentary-type group with a photocell?
- A: When you only want the photocell to turn the relays OFF, or only want it to turn relays ON.
- Even when using a schedule to turn the lights off (for example at 11:00pm), one would usually program the Photocell as "Maintain". This ensures the lights turn off at dawn in the event that an override "ON" command switched the lights on during the night.



LIGHTING CONTROL & DESIGN

905 Allen Ave • Glendale, CA 91201 • Support 800-345-4448 • www.lightingcontrols.com

LCD88FA03Sept08

APPENDIX

APPENDIX

- a) Installation Guide - GR1404 & I408
- b) Installation Guide - GR1416
- c) Installation Guide - Chelsea DigitalSwitch
- d) Installation Guide - Photocell
- e) Installation Guide - Digital Input (DI)

- f) Connecting Occupancy Sensors
- g) Clock/Programming Navigation Tree
- h) Technical Glossary



THE BLUE BOX™ LT

INSTALLATION GUIDE

GR1404LT & GR1408LT

LCDB814-04/08/G03Sep08



Lighting Control & Design
905 Allen Ave, Glendale CA 91201
Tel: 800-345-4448 • www.lightingcontrols.com

INSTRUCTIONS

PANEL MOUNTING

1. Use the drill template to pre-drill mounting holes for appropriate screw fasteners and mount panel.

Backplate can be removed at rough-in.

LINE VOLTAGE CONNECTIONS

2. Connect to power (120V or 277V) neutral and ground lugs. Connect to dedicated breaker (see next page for emergency loads).
3. Follow the Panel Schedule on the inside door. If panel is factory pre-programmed connect per line and load directions. If not, document field-made connections. (back page)
4. Tighten and then re-tighten lugs to 18 in/lbs.

Tip: Fault-check each circuit prior to energizing relays.

LOW VOLTAGE CONNECTIONS

5. Follow the "System Start-Up & Cabling Guide" to make bus connections using Cat. 5 with RJ45s.
6. Make-up connections to optional low voltage accessories:
7. Modem (see back page)
8. Photocell (see next page)
9. For contact closure devices use the optional DI Card (next page).

START UP

10. To start-up the panel as part of a new system refer to the "System Start-Up & Cabling Guide". To start-up the Blue Box in an existing network, refer to "Adding New Devices" in "The Blue Box LT O&M Manual".

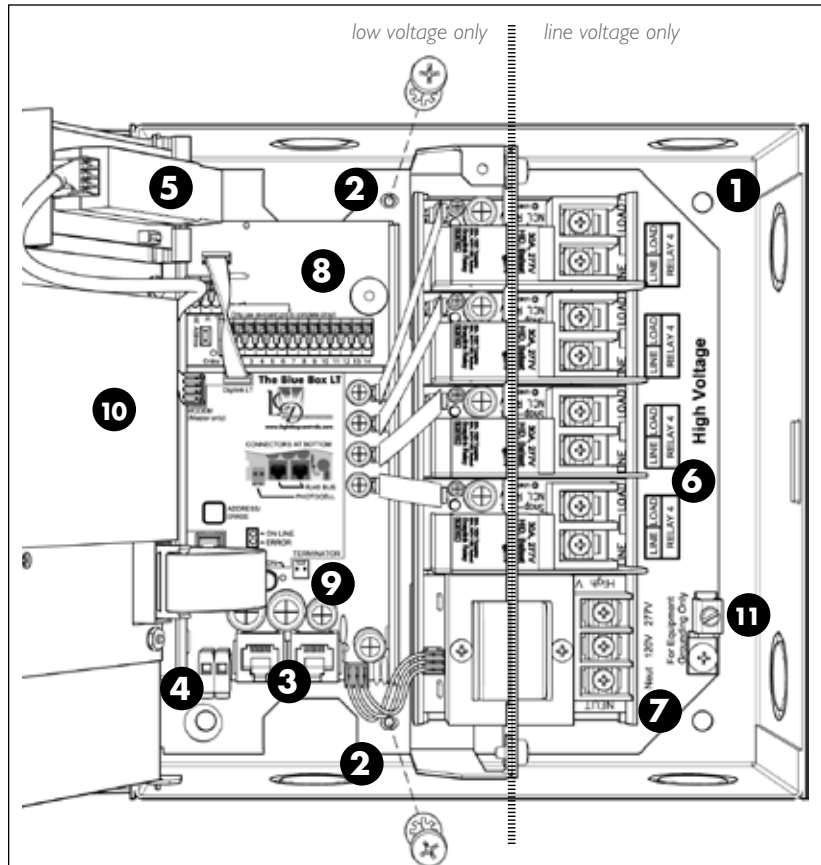

For a complete parts list refer to the Blue Box LT O&M Manual

- | | |
|--|---|
| ① Blue Box Mounting Holes (4). | ⑦ Dual-voltage (120V or 277V) power supply. |
| ② Back Plate Mounting Screws. | ⑧ (Optional) Digital Input Card. DI 14 (or DI6 with enable/disable) inputs. |
| ③ RJ45 sockets for GR 2400 bus. | ⑨ Terminator pins. Terminate the bus only after the "System Start-Up and Cabling Guide" has been completed. |
| ④ Photocell Input (master only). The Photocell may control any relay(s) in any panel(s). | ⑩ White door and back of DTC clock (master panel only). |
| ⑤ Optional Modem. Analog phone line connects to RJ-12 socket. | ⑪ Grounding LUG. |
| ⑥ Relays (line and load lugs). | |

HOOK UP DIAGRAMS

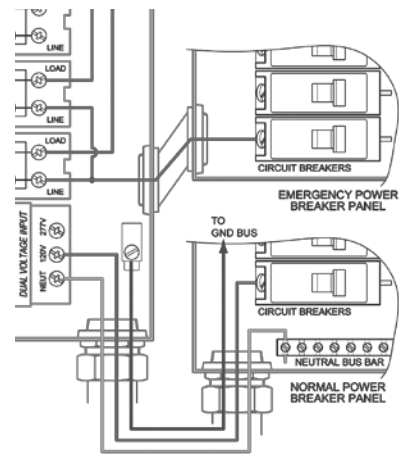
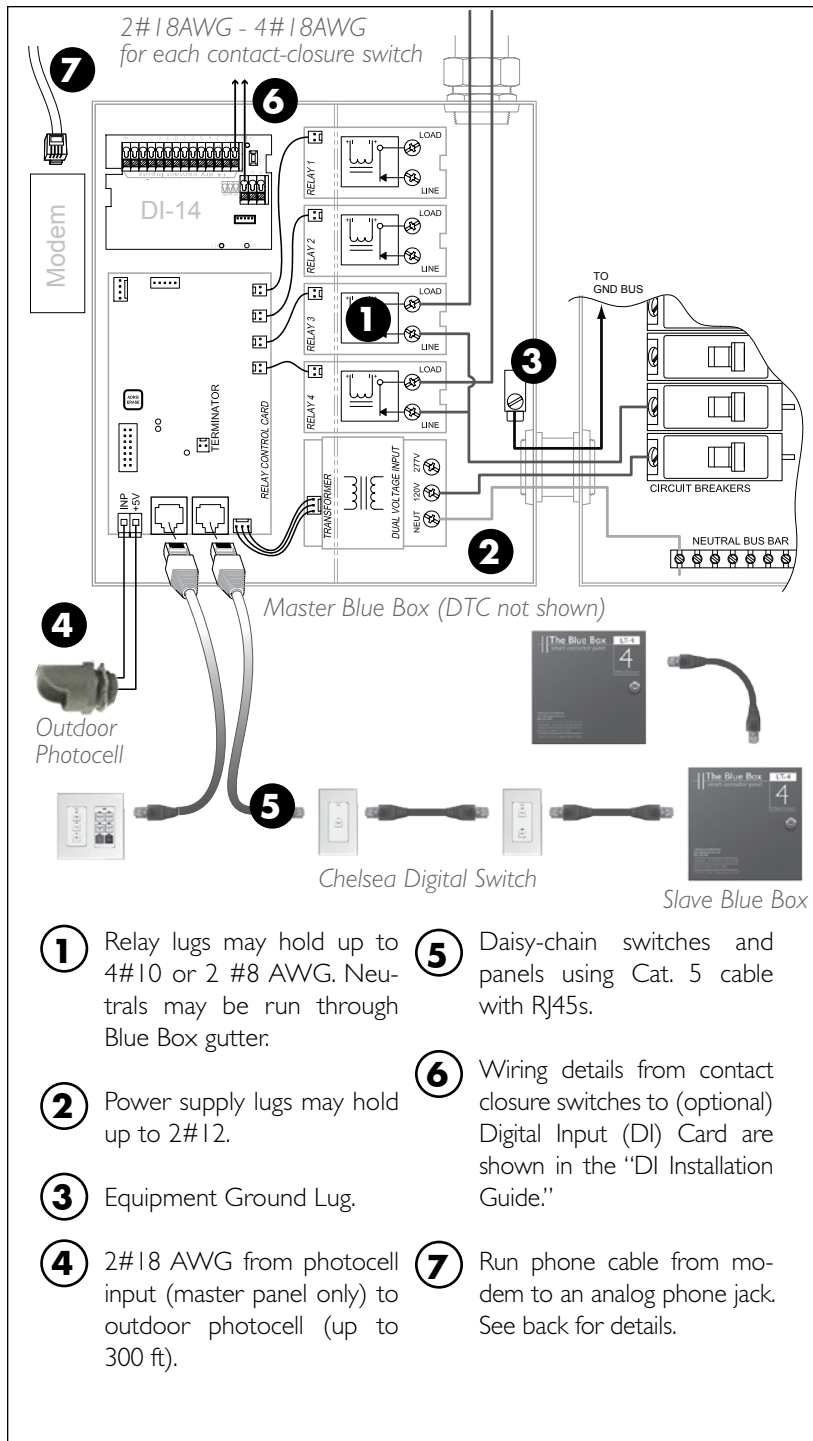

EMERGENCY LOADS

To switch relays on in the event of a loss of normal power, feed the power supply with a dedicated normal-power breaker.

To maintain relay status (on or off) in the event of a loss of normal power, feed the power supply with a dedicated emergency-power breaker via a server-quality UPS (load is less than 10 watts).

LCDB811404/08(G03)Sept08

MORE INSTALLATION DETAILS

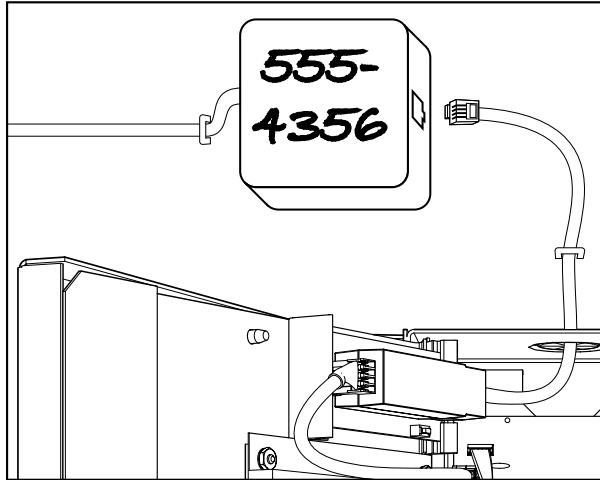

MODEM INSTALLATION DETAILS

1. Run an analog phone line to a phone outlet near the Blue Box LT.
2. Write the modem phone number on the outlet.
3. Connect to the modem using a phone cord.

Note: Do not use Digital Phone lines from a PBX system, it will not work.

Relay	Breaker # Line / Feed	Voltage 120 / 277	Load Name
R1	_____	_____	_____
R2	_____	_____	_____
R3	_____	_____	_____
R4	_____	_____	_____
R5	_____	_____	_____
R6	_____	_____	_____
R7	_____	_____	_____
R8	_____	_____	_____

FILL OUT THE PANEL SCHEDULE!

In the door of the Blue Box is a Panel Schedule. Use it to keep track of load names and the relays that control them.

Use the Line Feed column to ensure that the correct breakers are on and off when they need to be. If servicing the relay or the circuit, for example, the breaker should be off. If the lights are not turning on, the breaker should be checked to ensure that it is neither off nor tripped.

Load name is pretty important as it connects the breaker to the relay to the actual lights being controlled. Make up any name that is descriptive for you.

LIGHTING CONTROL & DESIGN

905 Allen Ave • Glendale, CA 91201 • Support 800-345-4448 • www.lightingcontrols.com

LCDBB14/01/08/G03Sept08



THE BLUE BOX™ LT

INSTALLATION GUIDE

GR1416LT

LCD1881416IG03Sept08



Lighting Control & Design
905 Allen Ave, Glendale CA 91201
Tel: 800-345-4448 • www.lightingcontrols.com

LIGHTING CONTROLS

INSTRUCTIONS

PANEL MOUNTING

1. Use the drill template to pre-drill mounting holes for appropriate screw fasteners and mount panel.

Backplate can be removed at rough-in.

LINE VOLTAGE CONNECTIONS

2. Connect to power (120V or 277V) neutral and ground lugs. Connect to dedicated breaker (see next page for emergency loads).
3. Follow the Panel Schedule on the inside door. If panel is factory pre-programmed connect per line and load directions. If not, document field-made connections. (back pg).
4. Tighten and then re-tighten lugs to 18 in/lbs.

Tip: Fault-check each circuit prior to energizing relays.

LOW VOLTAGE CONNECTIONS

5. Follow the "System Start-Up and Cabling Guide" to make bus connections using Cat. 5 with RJ45s.
6. Make-up connections to optional low voltage accessories:

- Modem (see back pg)
- Photocell (next pg)
- For contact closure devices use the optional DI Card. (next pg)

START UP

7. To start-up the panel as part of a new system refer to the "System Start-Up and Cabling Guide".

To start-up the Blue Box in an existing network, refer to "Adding New Devices" in the Blue Box LT "O&M Manual".

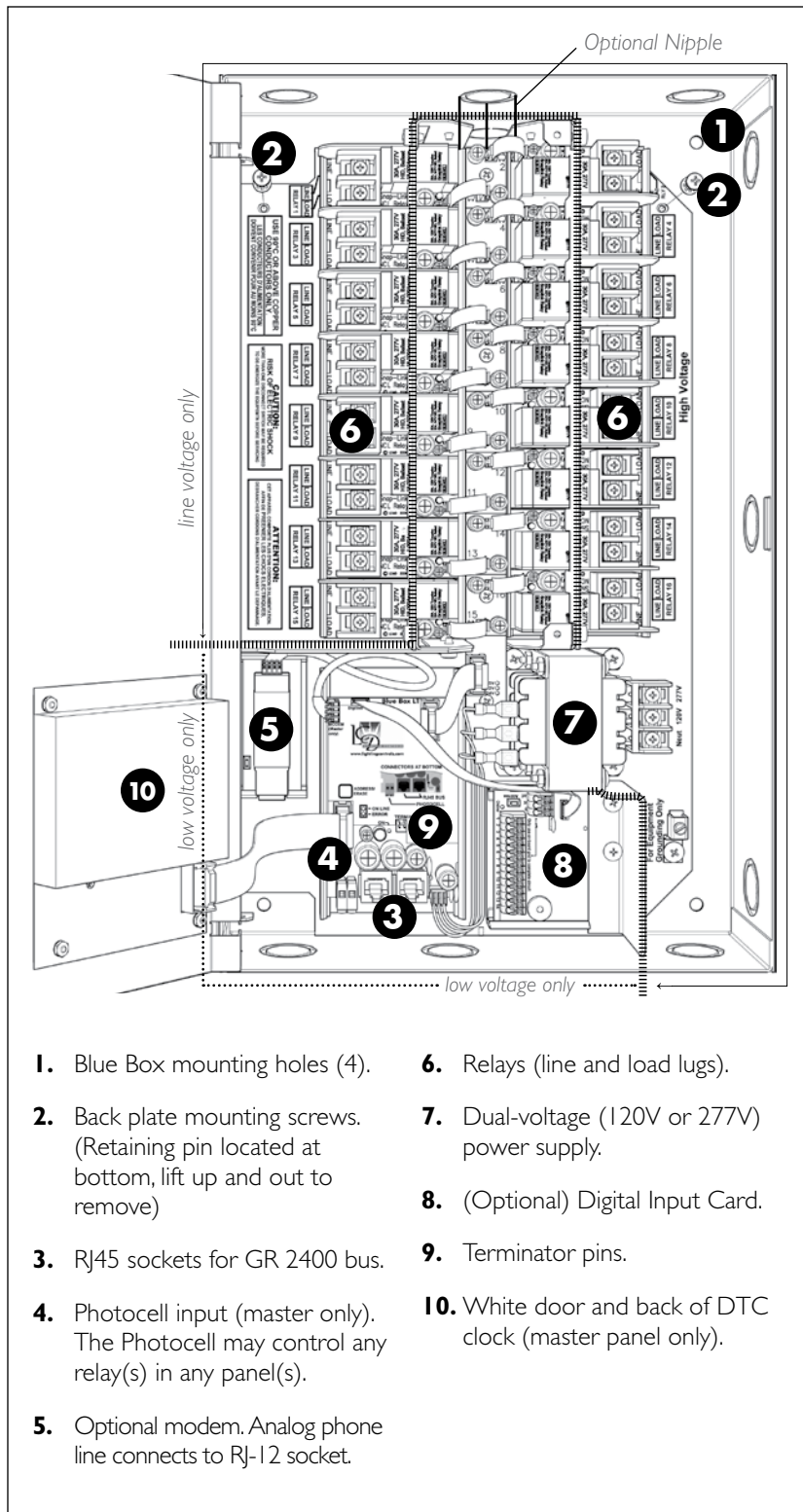

1. Blue Box mounting holes (4).
2. Back plate mounting screws. (Retaining pin located at bottom, lift up and out to remove)
3. RJ45 sockets for GR 2400 bus.
4. Photocell input (master only). The Photocell may control any relay(s) in any panel(s).
5. Optional modem. Analog phone line connects to RJ-12 socket.
6. Relays (line and load lugs).
7. Dual-voltage (120V or 277V) power supply.
8. (Optional) Digital Input Card.
9. Terminator pins.
10. White door and back of DTC clock (master panel only).

HOOK UP DIAGRAM

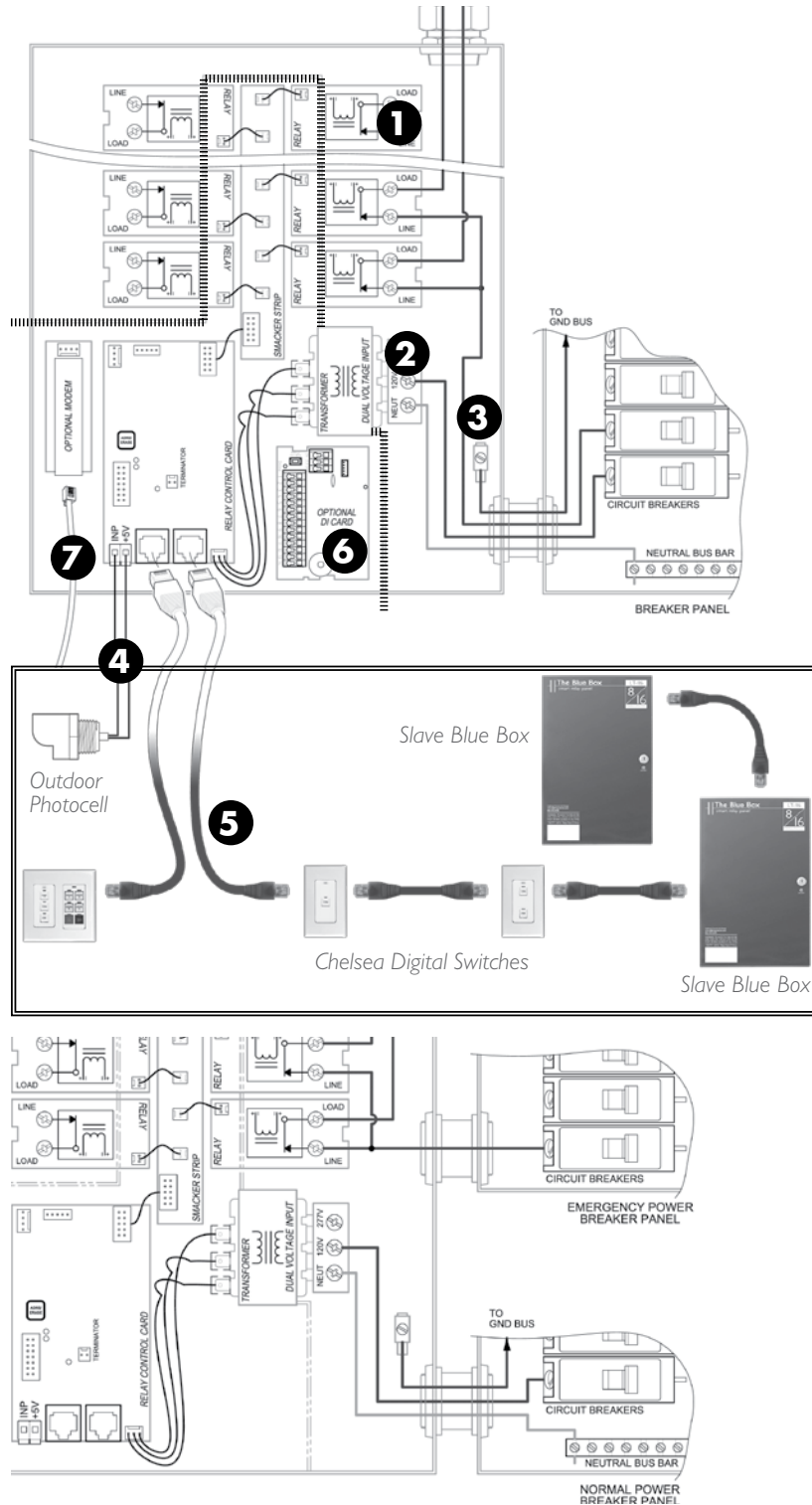

CONNECTIONS DETAILS

For internal wiring connections refer to The Blue Box LT “O&M Manual”.

1. Relay lugs may hold up to 4#10 or 2 #8 AWG. Neutrals may be run through The Blue Box LT gutter.
2. Power supply lugs may hold up to 2#12. Use a dedicated power supply breaker (see below for controlling emergency loads).
3. Ground Lug - for grounding The Blue Box LT only.
4. 2#18 AWG from photocell input (master panel only) to outdoor photocell (up to 300 ft). If longer, use shielded cable.
5. Cat. 5 from RJ45 sockets connect The Blue Box LT to other digital devices (switches, relay panels, etc.). Refer to “System Start-Up Cabling Guide” when making these connections, and before powering-up The Blue Box LT.
6. Wiring details for optional Digital Input Card are shown on the “DI Installation Guide.”
7. Run 4-conductor, flat cable from modem to an analog phone jack. Refer “Modem Installation Guide.”

EMERGENCY LOADS

To switch emergency on in the event of a loss of normal power, feed the power supply with a dedicated normal-power breaker (left).

To hold relay status (on or off) in the event of a loss of normal power, feed The Blue Box power supply with a dedicated emergency-power breaker via a server-quality UPS (load is less than 10 watts).



LIGHTING CONTROL & DESIGN

905 Allen Ave • Glendale, CA 91201 • Support 800-345-4448 • www.lightingcontrols.com

LCD18814161G03Sept08



CHELSEA (DIGITAL SWITCH)

INSTALLATION GUIDE

FIELD PROGRAMMED SWITCHES ONLY

CHELSEA SWITCH OVERVIEW

MANUAL CONTROL - OVERRIDE CONTROL

Supposing you have a relay panel that turns the lights on and off automatically with time schedules and a photocell; How would you extend the lighting (override a time schedule) when staying late? How would you turn the lights on first thing in the morning?

The Chelsea DigitalSwitch™ can be programmed to turn relays on and off during business hours and act as an override switch with a programmable timer value for after-hours. It can control one relay, or any combination of relays in any panel(s).



LCD88CIG03Sept08



Lighting Control & Design
905 Allen Ave, Glendale CA 91201
Tel: 800-345-4448 • www.lightingcontrols.com

CHELSEA INSTALLATION INSTRUCTIONS FOR FIELD-PROGRAMMED SWITCHES

These instructions supersede the instructions on the side of the shipping box for any field-programmed Chelsea DigitalSwitches™.

PREPARATION

1. Record the serial number of the Chelsea DigitalSwitch™ onto the System Device Schedule located in the door of the Master Blue Box. You will need this later for startup and programming.

SYSTEM DEVICE SCHEDULE: (for Master Panels)

(Master) LCP1	3 btn sw	6 btn sw
Device Type	Device Type	Device Type
elec rm	Hallway	lobby
Location	Location	Location
ce80	8875	4685
Serial #	Serial #	Serial #
1		
Address	Address	Address

Note the serial number and device type on the back of the SYSTEM DEVICE SCHEDULE.

CONNECTION

2. Run Cat. 5 to the low voltage ring or switch box. Daisy-chain devices using Cat. 5 with RJ45s*.
3. Once cables have been properly tested*, connect them to the RJ45 sockets on the back of the Chelsea DigitalSwitch™.

MOUNTING

4. Mount the Chelsea DigitalSwitch™ like any standard decorator style switch. It fits in any standard Decorator style wall plate (provided by the installer).

PROGRAMMING & COMMISSIONING

5. Once the system has been powered up* begin switch button programming per the programming section of The Blue Box "O&M Manual".
6. Once programmed, exercise each button on each switch several times to ensure that it is operating per customer requirements.

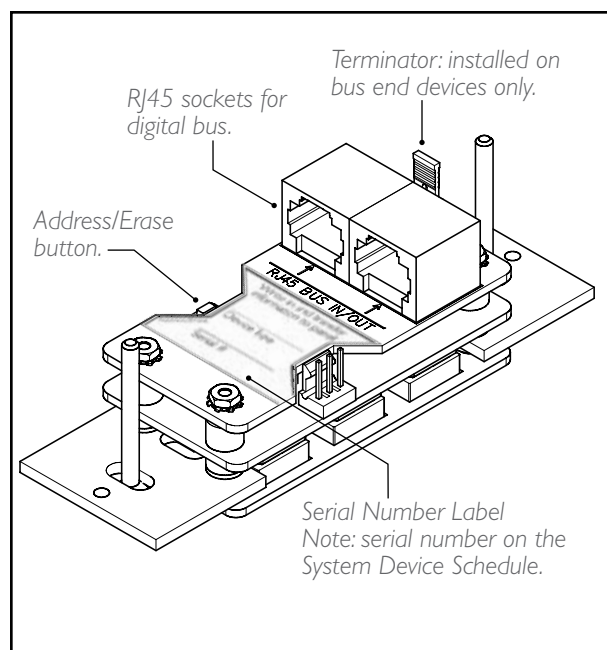
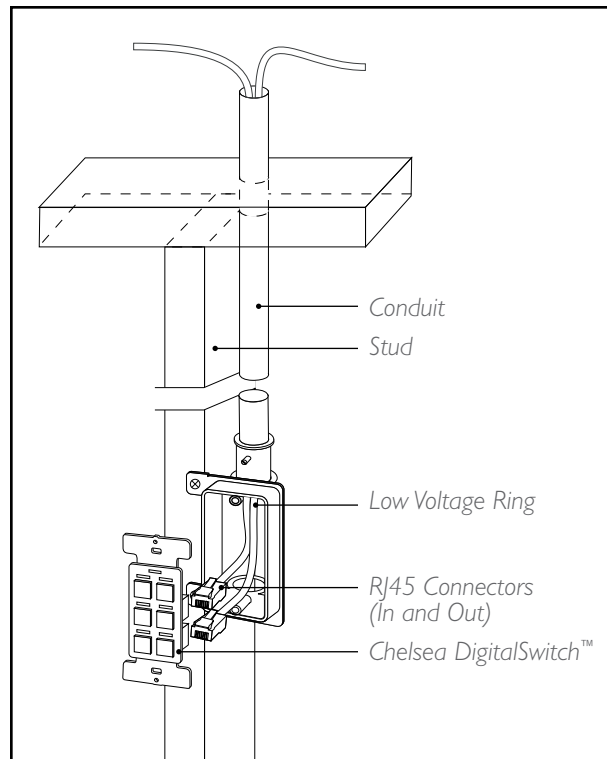

* Refer to The Blue Box LT "System Start-Up & Cabling Guide".



PCO (OUTDOOR PHOTOCELL) INSTALLATION GUIDE

OUTDOOR PHOTOCELL (PCO) OVERVIEW



CONNECTED TO THE MASTER BLUE BOX LT

If connected to the photocell inputs of a master Blue Box, the PCO must control relays via one or more of the first 8 clock schedules (photocell on, time clock off, etc.); each with a unique "on" or "off" trigger – programmable at any analog value (1 – 1020).

CONNECTED TO PHOTOCELL (PCC- CARD)

If the PCO is connected to a photocell card (PCC1 or PCC3), it can be programmed to directly switch relays on and off at any analog value (1 – 1020) with a programmable time delay, but can not be included in a time schedule.

LCDB89PCOIG03Sept08



Lighting Control & Design
905 Allen Ave, Glendale CA 91201
Tel: 800-345-4448 • www.lightingcontrols.com

INSTALLATION INSTRUCTIONS

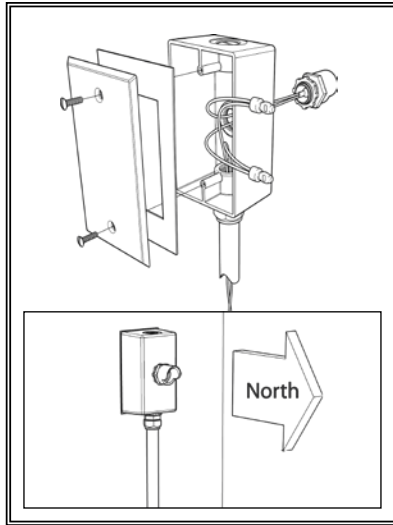
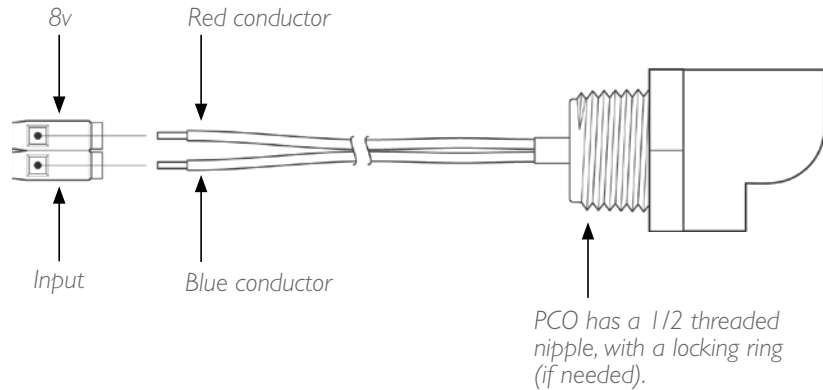

Figure A:

Red conductor to 8v (common)
Blue conductor to "Input"



ROOF-MOUNTING THE PCO

1. Roof mount the PCO "hood up" with an unobstructed view of the north sky as possible. Avoid aiming at any surfaces that might reflect sunlight directly into the PCO lens.

CONNECTION

2. Connect the PCO to the photocell inputs of a master Blue Box LT, a PCC1 or PCC3 photocell card with 2#18, up to 300 feet away.

COMMISSIONING

3. Once the system has been powered up per the steps of the "System Start-Up & Cabling Guide", complete the following test to verify the photocell is connected and aimed correctly — facing North.

Follow the correct commissioning steps in the "Commissioning Procedures".

COMMISSIONING PROCEDURES

1. Read the Light Level from the photocell to ensure placement and functionality.
When connected to a Blue Box LT, navigate to :
MAIN MENU > USER MENU > REVIEW SCHEDULE > PCELL ON
When connected to a PCC Card, navigate to:
MAIN MENU > USER MENU > PROGRAM SWITCH > PHOTOCELL (1 OR 3) > TRIGGER (1-10) > ON MODE/OFFMODE
2. If the display reads in the range of 0 – 1020, this test is a pass, and programming can be started.
3. If display reads "1020":
Cover PCO lens and check readings. If readings drop close to "0", adjust the aim of the photocell to avoid direct or reflected sunlight. If display still reads "1020", check for reversed connection (see Figure A above).
4. If reading is stuck at "0", ensure photocell is securely connected. If reading does not change, contact LC&D Tech Support.



THE BLUE BOX™ LT

DIGITAL INPUT CARD INSTALLATION GUIDE (FOR CONTACT CLOSURES)

DIGITAL INPUT CARD OVERVIEW

The Digital Input (DI) Card is mounted inside the Blue Box. It provides a gateway for almost any contact closure switch or occupant sensor to control any relay(s) in any Blue Box(es).

The DI Card is available in two sizes and features sets.

DI-14: The DI-14 Card has 14 programmable dry-contact inputs that can not be “disabled” or “enabled”.

DI-6: The DI-6 Card has 6 programmable dry-contact inputs that may be “enabled” and “disabled” - particularly useful when connecting occupant sensors.

LCD88D/C/G03Sept08



Lighting Control & Design
905 Allen Ave, Glendale CA 91201
Tel: 800-345-4448 • www.lightingcontrols.com

LIGHTING CONTROLS

MOUNTING INSTRUCTIONS

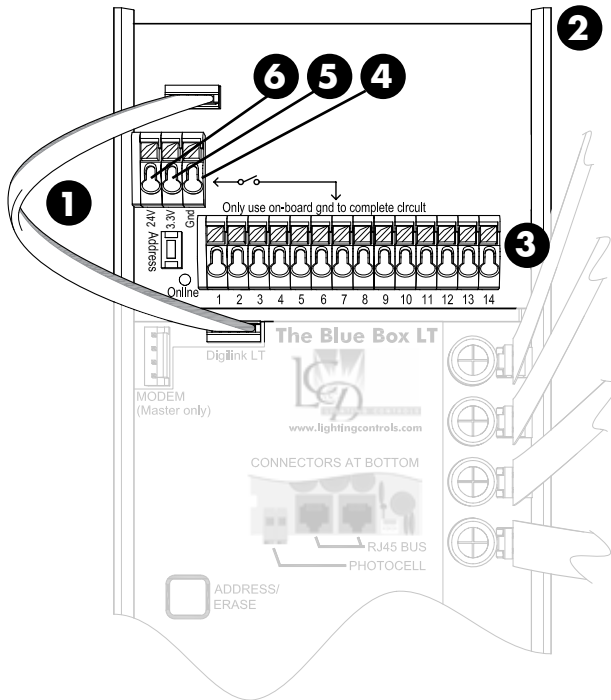

MOUNTING/INSTALLATION

If your DI Card is already installed in the Blue Box LT, skip this section and proceed to “Connecting Inputs” on the next page.

To add the DI Card to any Blue Box LT panel:

- a) De-power the Master Panel (the relays in that panel will automatically close).
- b) If not already done, de-power the panel you are adding the DI Card to (the relays in that panel will close).
- c) Snap the DI Card into the snap track above the control card in The Blue Box LT.
- d) Connect the board-to-board cable to the control card.
- e) Address the new DI Card, per the addressing steps on the back of this Installation Guide.
- f) Once the addressing steps are complete, make-up the contact closure connections (next page).

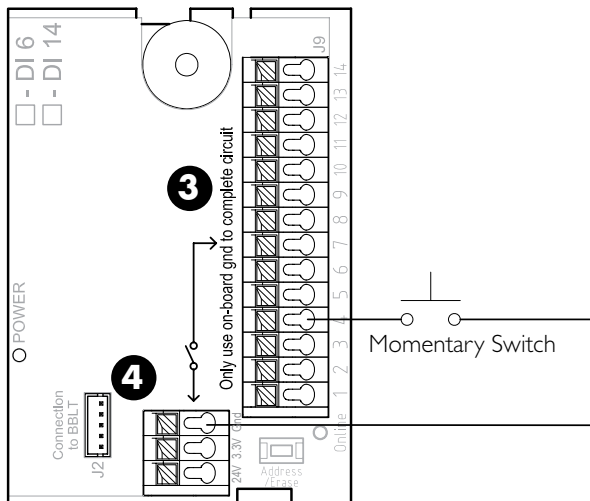

CALLOUT LEGEND:

For a complete parts list refer to The Blue Box LT O&M Manual.

1. Board-to-board ribbon cable provides power and digital signal to the DI Card.
2. DI Card snaps into existing snap track on The Blue Box LT panel.
3. 6 or 14 programmable contact closure inputs (DI-14 shown). Each input is numbered.
4. Ground input. Use only the on-board Ground as common. Do not use Earth Ground!
5. 3V output supplies power to LED pilot lights (LC&D contact closure switches only).
6. 24V output (500 mA) for occupant sensors.

CONNECTING INPUTS

MAKING CONNECTIONS & SWITCH TYPES

1. Strip the conductor about 3/8".
2. Using a flathead screwdriver push connector release button until fully disengaged and then gently add or remove wire.
3. After making any connections, tug wire to verify it is engaged properly.

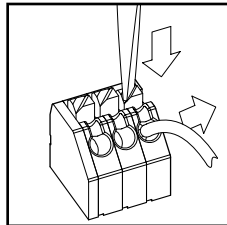

NOTE: Contact connectors can only accept (1) #18 AWG wire. For Ground Connections with more than 1 input: wire nut all ground wires together; connect to a single wire and insert into the appropriate ground (GND) position.

Connect contact-closure devices by following the typical diagrams. Programming details are found in the O&M Manual. Refer to the Switch Type for programming.

- ! Never complete a contact closure circuit with "earth ground" or risk system failure
- ! Only the DI-6 supports the enable and disable feature which is particularly important for occupant sensors.

MOMENTARY CONTACT CLOSURE SWITCH

Any push button switch is acceptable as long as it is designed for low voltage, low current (non-oxidizing contacts) contact circuits. Program as a "Momentary On", "Momentary Off", or "Toggle" switch type.

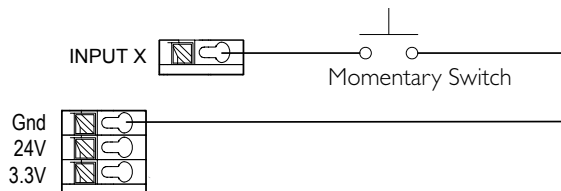

MOMENTARY SWITCH WITH LED PILOT LIGHT

This only works with LC&D contact closure switches. The input provides a pilot light signal when operated. Program as a "Momentary On", "Momentary Off", or "Toggle" switch type.

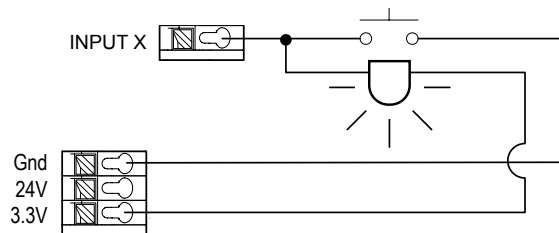

SPST MAINTAINED SWITCH OR RELAY

Program as "Maintain" switch type.

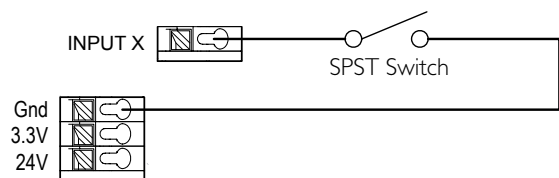

MOMENTARY DT SWITCH

Program one input as "Momentary On" and the other input as "Momentary Off". The "center-off" SPDT switch will "positively" turn lights on or off.



GENERIC OCCUPANT SENSOR

Program per the "Occupant Sensor" section of the O&M Manual. Refer to www.lightingcontrols.com for specific occupant sensor manufacturers' hook-up drawings.

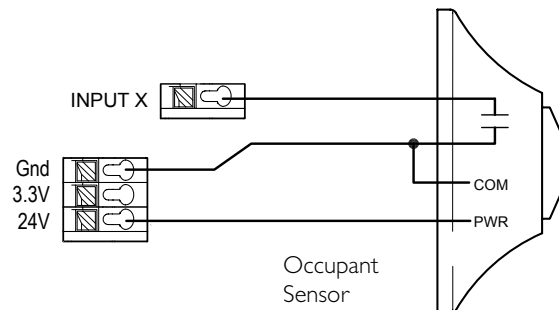

AUTO-ASSIGNING ADDRESSES TO A NEW DEVICE

Auto-addressing any newly added digital device (switch, relay panel, DI Card, etc.) to any system with a Blue Box LT Master Panel is done as follows:

1. After completing the product installation guide(s), power up all Slave Panels and active devices first and then power up the Master Panel.
2. The main screen will be displayed for a few seconds, after which the screen below will be displayed. TAB to YES and press ENTER to auto-address the new device(s). If the number of devices detected does not match the number of devices present on the bus, proceed to troubleshooting section.

```
Found 1 device on the system that are
not used.
Would you like to auto-assign them?

YES / NO / ->
      Never Ask Again
```

3. To view address assignment, TAB to YES and press ENTER to go to the "Serial Number Scan" screen.

```
Assigned 1 device.
Review assignments by
scanning all serial numbers?

YES / NO
```

4. If adding more than one device, TAB to "Serial#" field and SCROLL UP or DOWN to review each device.

```
          SCAN by serial#
Serial# CE80
Adr: 1
Item Type: Switch
Mapd: 6 Btn. Switch
Address: OK
SAVE ADDRESS CHANGES
```

The "Serial Number Scan" screen displays the serial number, address, and device-type of any newly added device(s)

5. Add the new device(s) to the "System Device Schedule" on the back of the "Panel Schedule" located inside The Blue Box LT Master Panel for future programming.

(Master) LCP1 Device Type elec rm Location ce80 Serial # 1 Address	3 btn sw Device Type Hallway Location 8875 Serial # 3 Address	6 btn sw Device Type lobby Location 4685 Serial # 4 Address
DI-6 Device Type LCP 1 Location 4055 Serial # 7 Address	Device Type Location Serial # Address	Device Type Location Serial # Address

6. Not sure what the serial numbers are? Each device has a unique Serial Number label or do the following to "read" the Serial Number from the DTC clock:
7. Navigate to the "Read Address" screen: USER MENU > SETUP MENU > RESTRICTED > ADDRESSING-BUS SCAN > READ ADDRESS. The password to enter the RESTRICTED area is 900001.
8. Press the first button on a switch or the "Address/Assign" button. The screen will display the "Address" and "Serial number". Record this data on the "System Device Schedule." The system is now ready for Error Checking, EXIT repeatedly to navigate to the main menu.

ERROR CHECK

9. Navigate to the Error Statistics Screen. Use the path USER MENU > SETUP MENU > RESTRICTED > ADDRESSING-BUS SCAN > ERROR STATISTICS.
10. Tab to the field that says CLEAR and press ENTER to clear errors. If after 3 minutes no errors accumulate on this screen, your system is stable.
11. If errors continue to accumulate, refer to the "Error Check Troubleshooting" section in the Blue Box LT "O&M Manual" or "System Start-Up Cabling Guide" or call Technical Support: 1-800-345-4448.

LIGHTING CONTROL & DESIGN

905 Allen Ave • Glendale, CA 91201 • Support 800-345-4448 • www.lightingcontrols.com



BLUE BOX™ LT

OCCUPANT SENSORS HOOK-UP AND PROGRAMMING

LCD880SH-P03Sept08



Lighting Control & Design
905 Allen Ave, Glendale CA 91201
Tel: 800-345-4448 • www.lightingcontrols.com

INTRODUCTION

The DI inputs of the Blue Box allow a single occupant sensor to control multiple relays in a variety of different scenarios.

Sensors may be disabled by time of day if the DI6 is used, or may be included as part of a combined occupant sensor / daylight harvesting controls strategy.

Sensors from any manufacturer are allowed long as they have an “-R” (relay option) or dry contact output. Hook up is similar to a traditional power pack. Occupant sensors may be powered by the regulated 24V dc/300 mA supply on the DI card.

PROGRAMMING AN OCCUPANT SENSOR

Once the occupant sensor has been connected to the low-voltage dry contact input on the DI card, the input must be programmed.

All occupant sensors have contacts that send a “maintain” type closure to the dry contact inputs on the DI card and therefore must be programmed as such.

TO PROGRAM A DI INPUT

1. Navigate to the DI card inputs: USER MENU > PROGRAM SWITCH > SWITCH # > BUTTON #
2. Add/delete LOADs (relays) to the input(s) to which the occupant sensor(s) are connected. TAB to the Control Type and set it to “Maintain.”
3. If more than 8 relays need to be added, create a new Group you will be asked if you wish to press yes to accept.
4. Navigate back to the DI input and SCROLL to the Control Type and select the Group that contains the relays.

For more information on Groups and Group types, refer to the relevant section in the O&M.

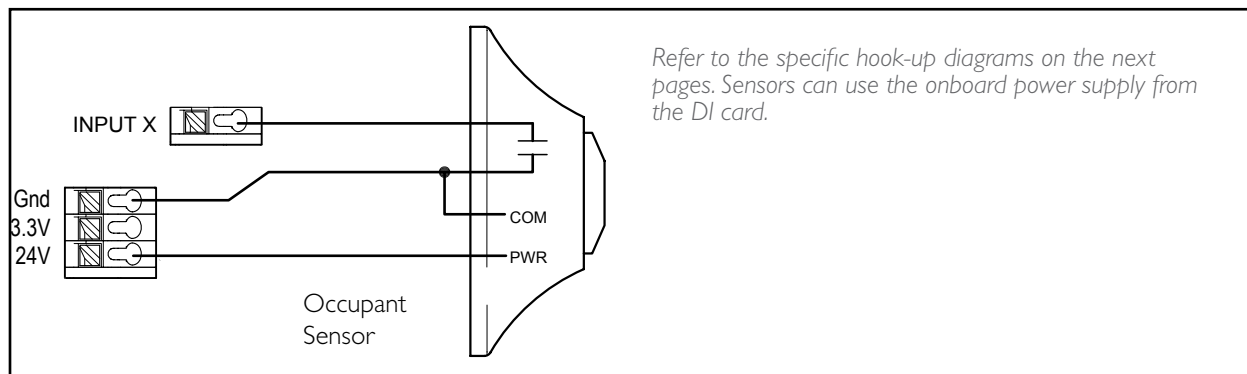

NOVITAS® BRAND OCCUPANT SENSORS

CONNECTION DETAILS

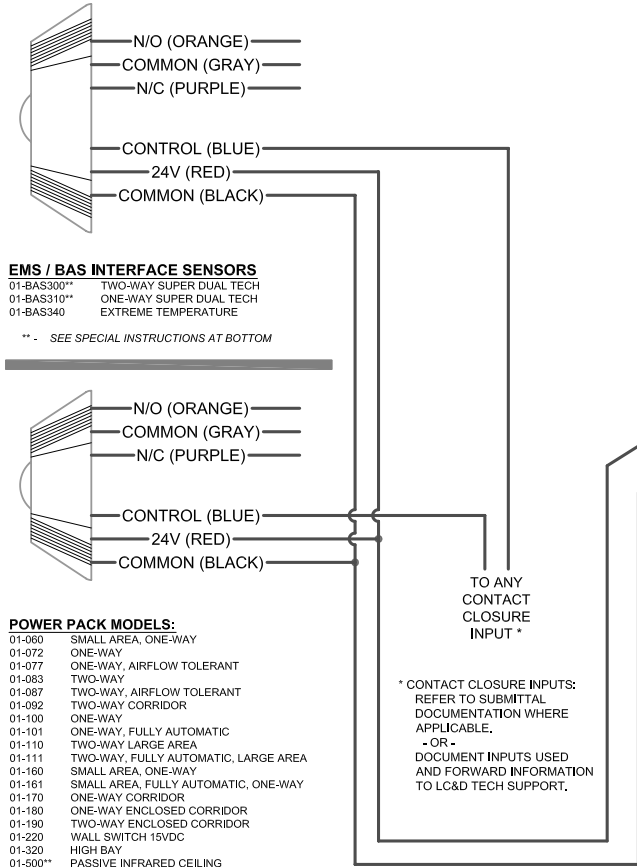

DI CARD (DI 14 shown)

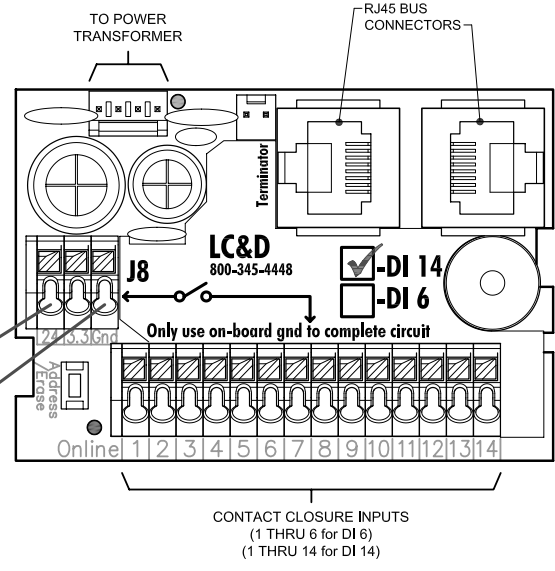

* CONTACT CLOSURE INPUTS:
 REFER TO SUBMITTAL DOCUMENTATION WHERE APPLICABLE.
 - OR -
 DOCUMENT INPUTS USED AND FORWARD INFORMATION TO LC&D TECH SUPPORT.

NOTE: NOVITAS® BRAND OCCUPANT SENSORS USE 'OPEN COLLECTOR' OUTPUTS ON THE CONTROL WIRE WHICH 'PULL LOW'. THEY ARE THE ONLY BRAND THAT CAN USE A CONTROL WIRE DIRECTLY. ALL OTHER BRANDS PULL HIGH.

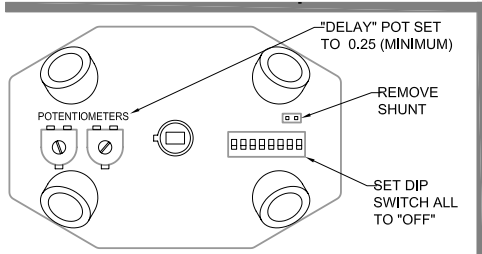

**** SPECIAL INSTRUCTIONS FOR MODELS: 01-310-BAS, 01-300-BAS, & 01-500**

1. REMOVE SHUNT FROM SENSOR'S CIRCUIT-BOARD.
2. SET DIP SWITCH, ALL TO "OFF" POSITION.
3. SET DELAY TO 0.25 (MINIMUM). SET RANGE PER MANUFACTURER'S (NOVITAS) INSTRUCTIONS.
4. USE CONDUCTORS INDICATED. DO NOT USE THE CONDUCTORS:
 "N/O" (ORANGE), "N/C" (PURPLE), "COMMON" (GRAY)

NOTES:
 THE DL2400 DI CARD PROVIDES 24VDC ONLY. VERIFY VOLTAGE COMPATIBILITY WITH THE SENSOR'S MANUFACTURER IF THE SPECIFICATION REQUIREMENTS INDICATE OTHERWISE.

CONNECTIONS WITH WIRE RUNS BEYOND 200 FEET REQUIRE THE USE OF SHIELDED CABLE TO AVOID SIGNAL INTERFERENCE.

PLEASE REFER TO THE MANUFACTURER'S INSTALLATION GUIDE FOR ANY OTHER PERTINENT INFORMATION THAT MAY BE REQUIRED FOR INSTALLATION OF THEIR PRODUCT. LIGHTING CONTROL & DESIGN CANNOT BE HELD LIABLE FOR CHANGES OR ANY OTHER ISSUES IN RELATION TO ANY PRODUCT MANUFACTURED BY OTHERS.

THE MODEL SHOWN IS THE MOST RECENT VERSION, PREVIOUS VERSIONS ONLY DIFFERED IN REGARD TO ENCLOSURE AND GENERAL ARRANGEMENT OF THEIR COMPONENTS. THEREFORE THIS INSTRUCTION SHEET MAY STILL APPLY.

IF THERE IS ANY CONCERN FOR ANY REASON REGARDING DISCREPANCIES BETWEEN THE DETAILS SHOWN HERE AND THOSE OF THE ACTUAL EQUIPMENT, WE HIGHLY RECOMMEND YOU CONTACT LC&D TECH SUPPORT PRIOR TO PROCEEDING.

LCD8805HP035qpt08

SENSOR SWITCH® BRAND OCCUPANT SENSORS

CONNECTION DETAILS

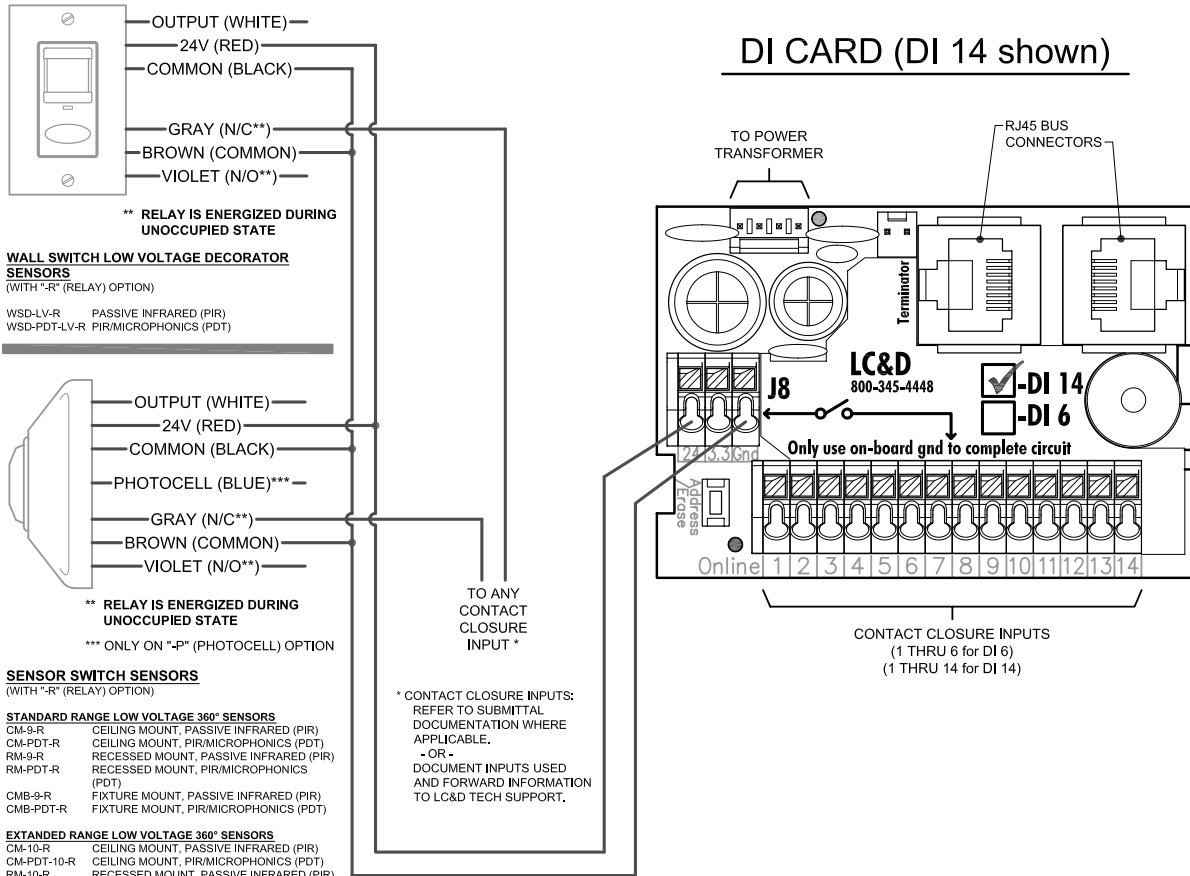

**** RELAY IS ENERGIZED DURING UNOCCUPIED STATE**

WALL SWITCH LOW VOLTAGE DECORATOR SENSORS
(WITH "R" (RELAY) OPTION)

WSD-LV-R PASSIVE INFRARED (PIR)
WSD-PDT-LV-R PIR/MICROPHONICS (PDT)

**** RELAY IS ENERGIZED DURING UNOCCUPIED STATE**

***** ONLY ON "P" (PHOTOCELL) OPTION**

SENSOR SWITCH SENSORS
(WITH "R" (RELAY) OPTION)

- STANDARD RANGE LOW VOLTAGE 360° SENSORS**
- CM-9-R CEILING MOUNT, PASSIVE INFRARED (PIR)
 - CM-PDT-R CEILING MOUNT, PIR/MICROPHONICS (PDT)
 - RM-9-R RECESSED MOUNT, PASSIVE INFRARED (PIR)
 - RM-PDT-R RECESSED MOUNT, PIR/MICROPHONICS (PDT)
 - CMB-9-R FIXTURE MOUNT, PASSIVE INFRARED (PIR)
 - CMB-PDT-R FIXTURE MOUNT, PIR/MICROPHONICS (PDT)
- EXTENDED RANGE LOW VOLTAGE 360° SENSORS**
- CM-10-R CEILING MOUNT, PASSIVE INFRARED (PIR)
 - CM-PDT-10-R CEILING MOUNT, PIR/MICROPHONICS (PDT)
 - RM-10-R RECESSED MOUNT, PASSIVE INFRARED (PIR)
 - RM-PDT-10-R RECESSED MOUNT, PIR/MICROPHONICS (PDT)
 - CMB-10-R FIXTURE MOUNT, PASSIVE INFRARED (PIR)
 - CMB-PDT-10-R FIXTURE MOUNT, PIR/MICROPHONICS (PDT)
- WIDE VIEW & HALLWAY LOW VOLTAGE SENSORS**
- WV-16-R WIDE VIEW - CORNER MOUNT, PASSIVE INFRARED (PIR)
 - WV-PDT-R WIDE VIEW - CORNER MOUNT, PIR/MICROPHONICS (PDT)
 - HW-13-R HALLWAY - WALL MOUNT, PASSIVE INFRARED (PIR)

- HIGHBAY LOW VOLTAGE 360° SENSORS**
- CM-6-R CEILING MOUNT, PASSIVE INFRARED (PIR)
 - RM-6-R RECESSED MOUNT, PASSIVE INFRARED (PIR)
 - CMB-6-R FIXTURE MOUNT, PASSIVE INFRARED (PIR)
- HIGHBAY LOW VOLTAGE AISLEWAY SENSORS**
- HM-50-R SURFACE MOUNT, PASSIVE INFRARED (PIR)
 - RM-50-R RECESSED MOUNT, PASSIVE INFRARED (PIR)
 - CMB-50-R FIXTURE MOUNT, PASSIVE INFRARED (PIR)
- HIGHBAY LOW VOLTAGE END-OF-AISLEWAY SENSORS**
- HM-10-R SURFACE MOUNT, PASSIVE INFRARED (PIR)
 - HMB-10-R FIXTURE MOUNT, PASSIVE INFRARED (PIR)

* CONTACT CLOSURE INPUTS:
REFER TO SUBMITTAL DOCUMENTATION WHERE APPLICABLE.
- OR -
DOCUMENT INPUTS USED AND FORWARD INFORMATION TO LC&D TECH SUPPORT.

DI CARD (DI 14 shown)

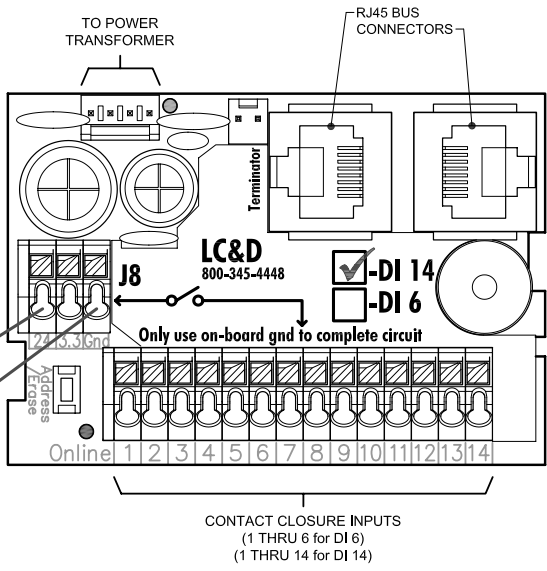

NOTES:
THE DL2400 DI CARD PROVIDES 24VDC ONLY. VERIFY VOLTAGE COMPATABILITY WITH THE SENSOR'S MANUFACTURER IF THE SPECIFICATION REQUIREMENTS INDICATE OTHERWISE.

CONNECTIONS WITH WIRE RUNS BEYOND 200 FEET REQUIRE THE USE OF SHIELDED CABLE TO AVOID SIGNAL INTERFERENCE.

PLEASE REFER TO THE MANUFACTURER'S INSTALLATION GUIDE FOR ANY OTHER PERTINENT INFORMATION THAT MAY BE REQUIRED FOR INSTALLATION OF THEIR PRODUCT. LIGHTING CONTROL & DESIGN CANNOT BE HELD LIABLE FOR CHANGES OR ANY OTHER ISSUES IN RELATION TO ANY PRODUCT MANUFACTURED BY OTHERS.

THE MODEL SHOWN IS THE MOST RECENT VERSION, PREVIOUS VERSIONS ONLY DIFFERED IN REGARD TO ENCLOSURE AND GENERAL ARRANGEMENT OF THEIR COMPONENTS. THEREFORE THIS INSTRUCTION SHEET MAY STILL APPLY.

IF THERE IS ANY CONCERN FOR ANY REASON REGARDING DISCREPANCIES BETWEEN THE DETAILS SHOWN HERE AND THOSE OF THE ACTUAL EQUIPMENT, WE HIGHLY RECOMMEND YOU CONTACT LC&D TECH SUPPORT PRIOR TO PROCEEDING.

LCDBB05HP03:Sept08

WATTSTOPPER® BRAND OCCUPANT SENSORS

CONNECTION DETAILS

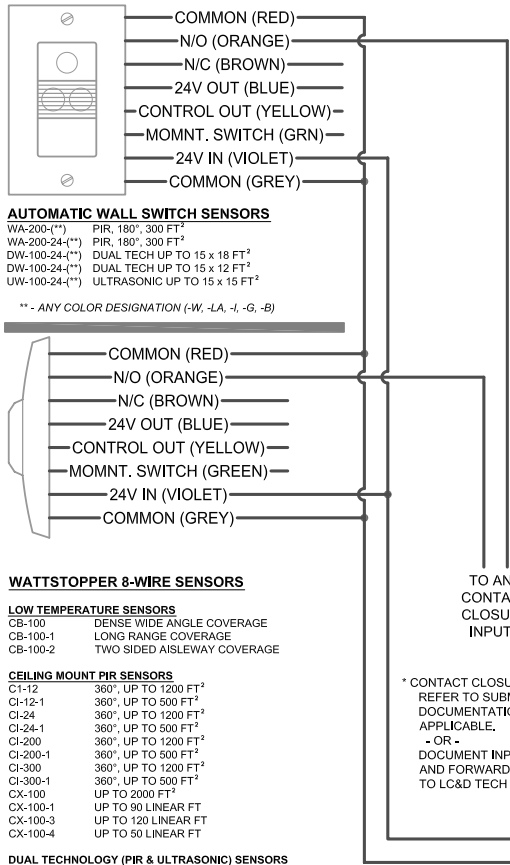

DI CARD (DI 14 shown)

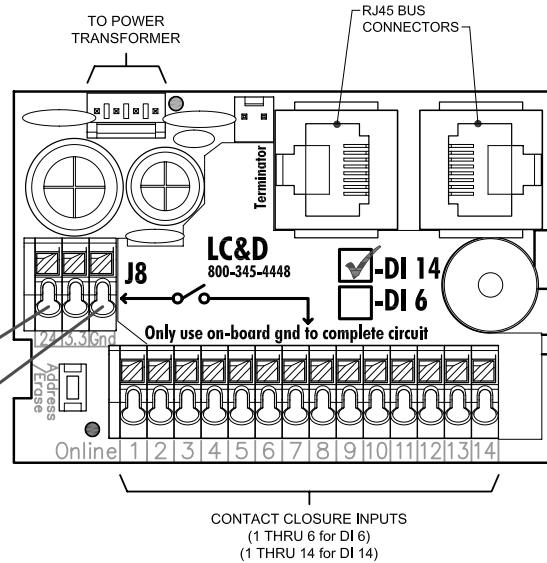

* CONTACT CLOSURE INPUTS:
REFER TO SUBMITTAL
DOCUMENTATION WHERE
APPLICABLE.
- OR -
DOCUMENT INPUTS USED
AND FORWARD INFORMATION
TO LC&D TECH SUPPORT.

IMPORTANT INSTRUCTIONS

SETTING SENSOR'S DELAY & OVERRIDE SETTING:
REFER TO MANUFACTURER'S DOCUMENTATION FOR DIP SWITCH CONFIGURATION AS DIFFERENT MODELS MAY VARY

- DELAY SETTING:** SET SENSOR'S DIP SWITCH AS REQUIRED FOR A 30 SECOND DELAY.
- OVERRIDE SETTING:** SET SENSOR'S DIP SWITCH AS REQUIRED FOR "NORMAL" OVERRIDE OPERATION.
- SET SENSITIVITY AS PER SITE REQUIREMENTS.

NOTES:
THE DL2400 DI CARD PROVIDES 24VDC ONLY. VERIFY VOLTAGE COMPATIBILITY WITH THE SENSOR'S MANUFACTURER IF THE SPECIFICATION REQUIREMENTS INDICATE OTHERWISE.

CONNECTIONS WITH WIRE RUNS BEYOND 200 FEET REQUIRE THE USE OF SHIELDED CABLE TO AVOID SIGNAL INTERFERENCE.

PLEASE REFER TO THE MANUFACTURER'S INSTALLATION GUIDE FOR ANY OTHER PERTINENT INFORMATION THAT MAY BE REQUIRED FOR INSTALLATION OF THEIR PRODUCT. LIGHTING CONTROL & DESIGN CANNOT BE HELD LIABLE FOR CHANGES OR ANY OTHER ISSUES IN RELATION TO ANY PRODUCT MANUFACTURED BY OTHERS.

THE MODEL SHOWN IS THE MOST RECENT VERSION, PREVIOUS VERSIONS ONLY DIFFERED IN REGARD TO ENCLOSURE AND GENERAL ARRANGEMENT OF THEIR COMPONENTS. THEREFORE THIS INSTRUCTION SHEET MAY STILL APPLY.

IF THERE IS ANY CONCERN FOR ANY REASON REGARDING DISCREPANCIES BETWEEN THE DETAILS SHOWN HERE AND THOSE OF THE ACTUAL EQUIPMENT, WE HIGHLY RECOMMEND YOU CONTACT LC&D TECH SUPPORT PRIOR TO PROCEEDING.

HUBBELL® BRAND OCCUPANT SENSORS

CONNECTION DETAILS

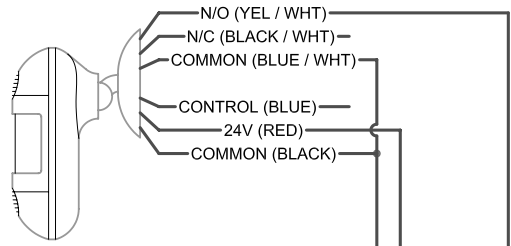

LightOWL WALL & CEILING MOUNT SENSORS

- LODTRP DUAL TECHNOLOGY ULTRASONIC & PASSIVE INFRARED (WALL OR CEILING MOUNT)
- LOIRWVRP PASSIVE INFRARED
- LOIRHBRP HIGH BAY INFRARED
- LODIARP DUAL TECHNOLOGY PASSIVE INFRARED & ACOUSTIC

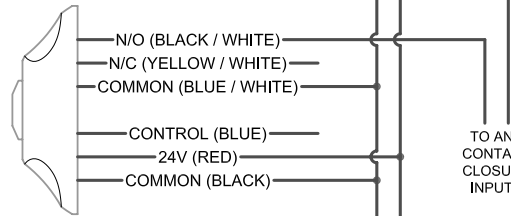

OMNI SERIES CEILING MOUNT SENSORS

- DUAL TECHNOLOGY ULTRASONIC & PASSIVE INFRARED CEILING SENSORS:
- OMNIDT500RP
 - OMNIDT1000RP
 - OMNIDT2000RP

- ULTRASONIC CEILING SENSORS:
- OMNIUS500RP
 - OMNIUS1000RP
 - OMNIUS2000RP

- PASSIVE INFRARED CEILING SENSORS:
- OMNIIR500RP
 - OMNIIR1000RP
 - OMNIIR2000RP

- DUAL TECHNOLOGY PASSIVE INFRARED & ACOUSTIC CEILING SENSORS:
- OMNIDIARP

* CONTACT CLOSURE INPUTS: REFER TO SUBMITTAL DOCUMENTATION WHERE APPLICABLE.
- OR -
DOCUMENT INPUTS USED AND FORWARD INFORMATION TO LC&D TECH SUPPORT.

DI CARD (DI 14 shown)

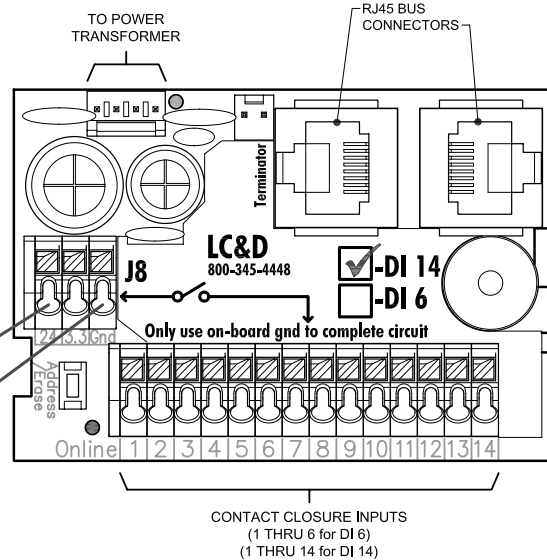

NOTES:
THE DL2400 DI CARD PROVIDES 24VDC ONLY. VERIFY VOLTAGE COMPATABILITY WITH THE SENSOR'S MANUFACTURER IF THE SPECIFICATION REQUIREMENTS INDICATE OTHERWISE.

CONNECTIONS WITH WIRE RUNS BEYOND 200 FEET REQUIRE THE USE OF SHIELDED CABLE TO AVOID SIGNAL INTERFERENCE.

PLEASE REFER TO THE MANUFACTURER'S INSTALLATION GUIDE FOR ANY OTHER PERTINENT INFORMATION THAT MAY BE REQUIRED FOR INSTALLATION OF THEIR PRODUCT. LIGHTING CONTROL & DESIGN CANNOT BE HELD LIABLE FOR CHANGES OR ANY OTHER ISSUES IN RELATION TO ANY PRODUCT MANUFACTURED BY OTHERS.

THE MODEL SHOWN IS THE MOST RECENT VERSION, PREVIOUS VERSIONS ONLY DIFFERED IN REGARD TO ENCLOSURE AND GENERAL ARRANGEMENT OF THEIR COMPONENTS. THEREFORE THIS INSTRUCTION SHEET MAY STILL APPLY.

IF THERE IS ANY CONCERN FOR ANY REASON REGARDING DISCREPANCIES BETWEEN THE DETAILS SHOWN HERE AND THOSE OF THE ACTUAL EQUIPMENT, WE HIGHLY RECOMMEND YOU CONTACT LC&D TECH SUPPORT PRIOR TO PROCEEDING.

LCD8BOSHP03:Sept08

LC&D® BRAND OCCUPANT SENSORS

CONNECTION DETAILS

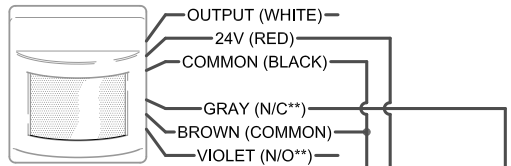

** RELAY IS ENERGIZED DURING UNOCCUPIED STATE

WALL SWITCH LOW VOLTAGE DECORATOR SENSORS

LCD-WSD-LV-R PASSIVE INFRARED (PIR)
LCD-WSD-PDT-LV-R PIR/MICROPHONICS (PDT)

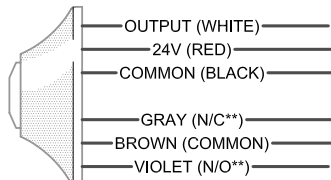

** RELAY IS ENERGIZED DURING UNOCCUPIED STATE

STANDARD RANGE LOW VOLTAGE 360° SENSORS

LCD-CM-9-R CEILING MOUNT, PASSIVE INFRARED (PIR)
LCD-CM-9-PDT-R CEILING MOUNT, PIR/MICROPHONICS (PDT)
LCD-RM-9-R RECESSED MOUNT, PASSIVE INFRARED (PIR)
LCD-RM-PDT-R RECESSED MOUNT, PIR/MICROPHONICS (PDT)
LCD-CMB-9-R FIXTURE MOUNT, PASSIVE INFRARED (PIR)
LCD-CMB-PDT-9-R FIXTURE MOUNT, PIR/MICROPHONICS (PDT)

EXTENDED RANGE LOW VOLTAGE 360° SENSORS

LCD-CM-10-R CEILING MOUNT, PASSIVE INFRARED (PIR)
LCD-CMT-PDT-10-R CEILING MOUNT, PIR/MICROPHONICS (PDT)
LCD-RM-10-R RECESSED MOUNT, PASSIVE INFRARED (PIR)
LCD-CMB-10-R FIXTURE MOUNT, PASSIVE INFRARED (PIR)
LCD-CMB-PDT-10-R FIXTURE MOUNT, PIR/MICROPHONICS (PDT)

WIDE VIEW & HALLWAY LOW VOLTAGE SENSORS

LCD-WV-16-R WIDE VIEW SENSOR, CORNER MOUNT, PASSIVE INFRARED (PIR)
LCD-WV-PDT-16-R WIDE VIEW SENSOR, CORNER MOUNT, PIR/MICROPHONICS (PDT)
LCD-HW-13-R HALLWAY, WALL MOUNT, PASSIVE INFRARED (PIR)

HIGHBAY LOW VOLTAGE 360° SENSORS

LCD-CM-6-R CEILING MOUNT, PASSIVE INFRARED (PIR)
LCD-RM-6-R RECESSED MOUNT, PASSIVE INFRARED (PIR)
LCD-CMB-6-R FIXTURE MOUNT, PASSIVE INFRARED (PIR)

HIGHBAY LOW VOLTAGE AISLEWAY SENSORS

LCD-HM-50-R SURFACE MOUNT, PASSIVE INFRARED (PIR)
LCD-RM-50-R RECESSED MOUNT, PASSIVE INFRARED (PIR)
LCD-CMB-50-R FIXTURE MOUNT, PASSIVE INFRARED (PIR)

HIGHBAY LOW VOLTAGE END-OF-AISLEWAY SENSORS

LCD-HM-10-R SURFACE MOUNT, PASSIVE INFRARED (PIR)
LCD-HMB-10-R FIXTURE MOUNT, PASSIVE INFRARED (PIR)

* CONTACT CLOSURE INPUTS: REFER TO SUBMITTAL DOCUMENTATION WHERE APPLICABLE.
- OR - DOCUMENT INPUTS USED AND FORWARD INFORMATION TO LC&D TECH SUPPORT.

DI CARD (DI 14 shown)

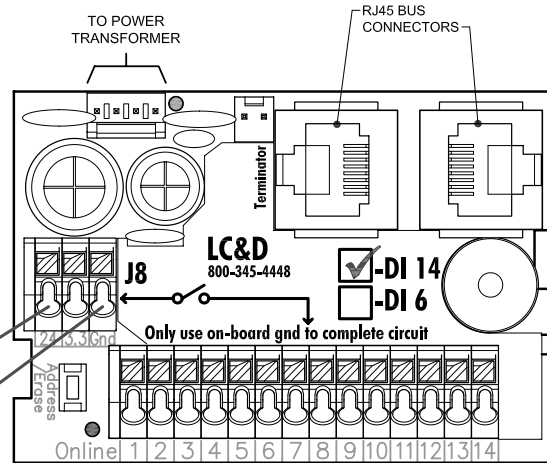

CONTACT CLOSURE INPUTS
(1 THRU 6 for DI 6)
(1 THRU 14 for DI 14)

LCD8805HP03Sep108

NOTE:
CONNECTIONS WITH WIRE RUNS BEYOND 200 FEET REQUIRE THE USE OF SHIELDED CABLE TO AVOID SIGNAL INTERFERENCE.

PLEASE REFER TO THE INSTALLATION GUIDE OF THE SENSOR FOR ANY OTHER PERTINENT INFORMATION THAT MAY BE REQUIRED FOR THE INSTALLATION THE PRODUCT.

THE MODEL SHOWN IS THE MOST RECENT VERSION, PREVIOUS VERSIONS ONLY DIFFERED IN REGARD TO ENCLOSURE AND GENERAL ARRANGEMENT OF THEIR COMPONENTS. THEREFORE THIS INSTRUCTION SHEET MAY STILL APPLY.

IF THERE IS ANY CONCERN FOR ANY REASON REGARDING DISCREPANCIES BETWEEN THE DETAILS SHOWN HERE AND THOSE OF THE ACTUAL EQUIPMENT, WE HIGHLY RECOMMEND YOU CONTACT LC&D TECH SUPPORT PRIOR TO PROCEEDING.



LIGHTING CONTROL & DESIGN

905 Allen Ave • Glendale, CA 91201 • Support 800-345-4448 • www.lightingcontrols.com

LCD880SHP03sept08

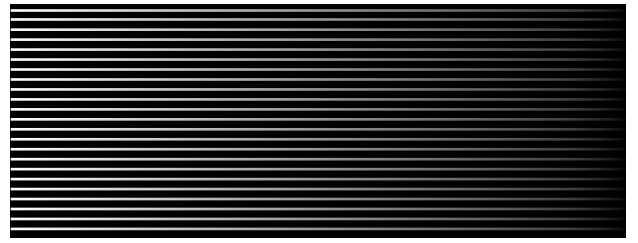
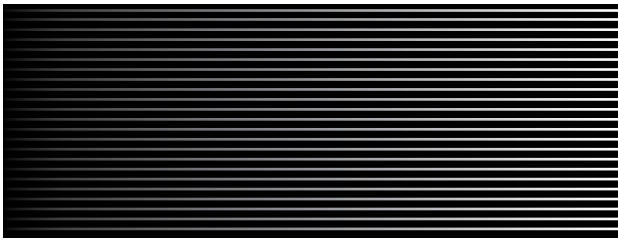

THE BLUE BOX™ LT

CLOCK/PROGRAMMING NAVIGATION TREE

LCD86CPNT03sept08



Lighting Control & Design
905 Allen Ave, Glendale CA 91201
Tel: 800-345-4448 • www.lightingcontrols.com

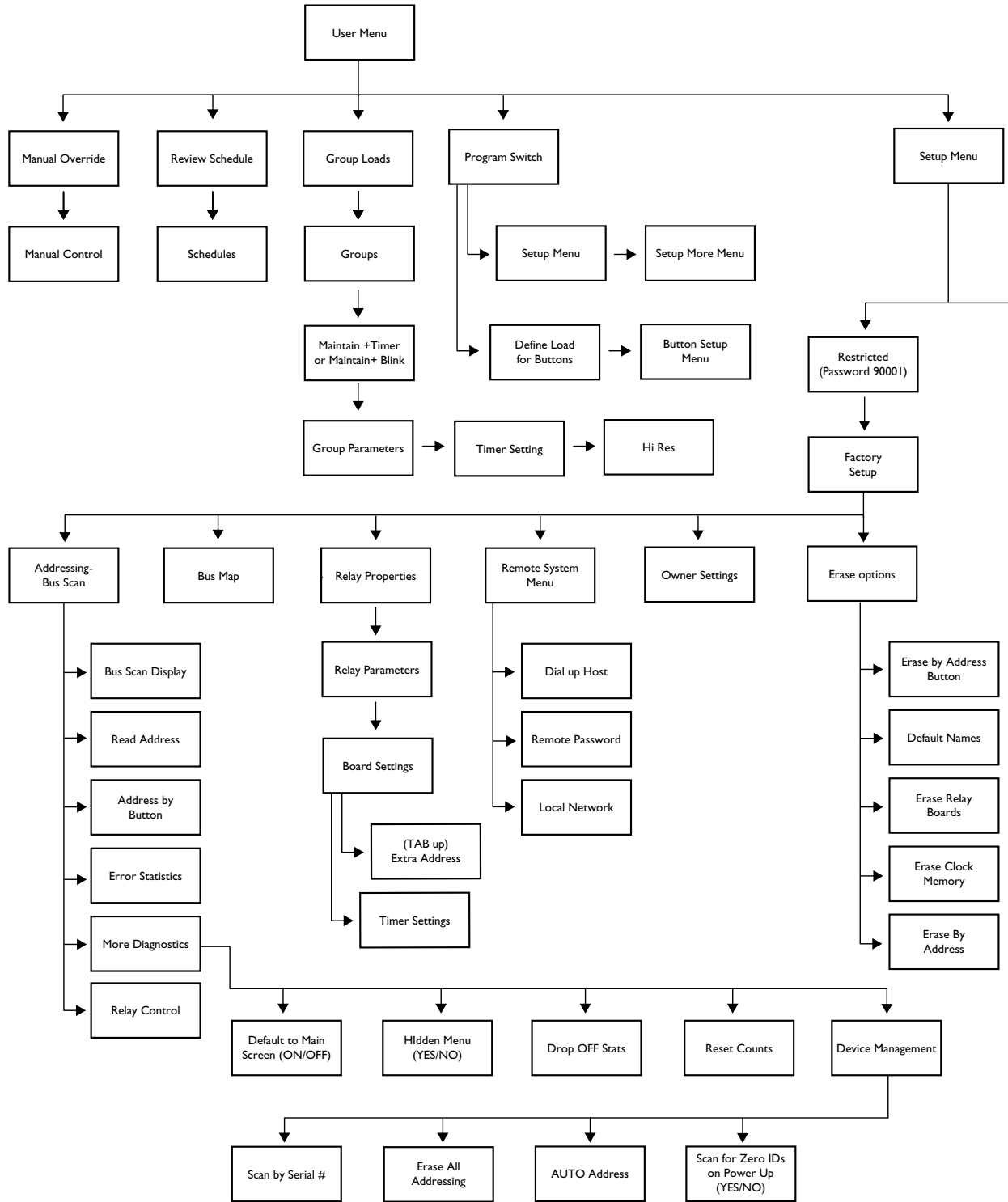

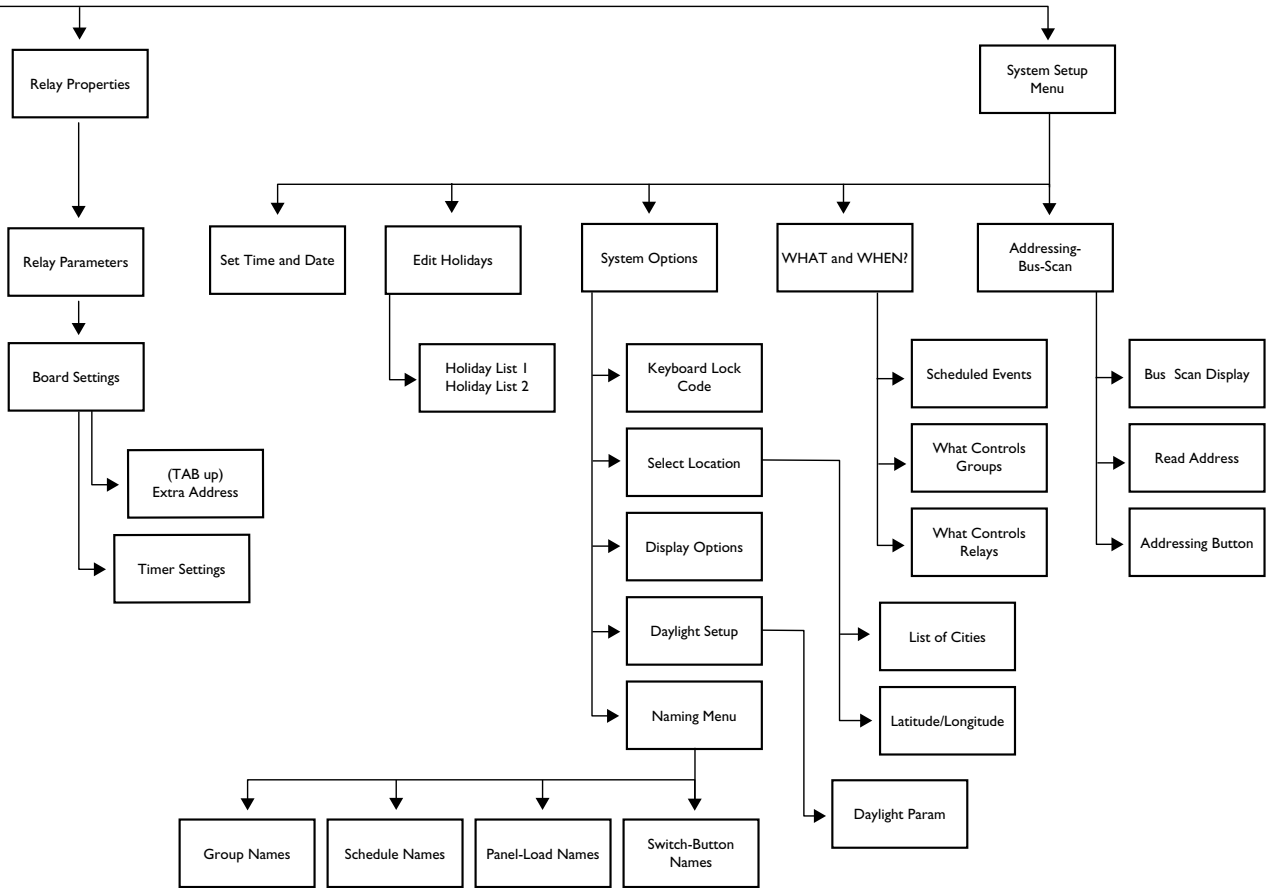

LCD88GPN1T03Sept08

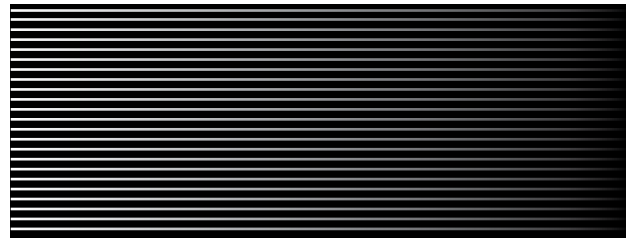
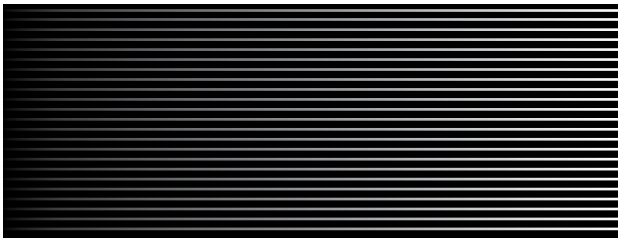

THE BLUE BOX™ LT

TECHNICAL GLOSSARY

LCDB81TG03Sept08



Lighting Control & Design
905 Allen Ave, Glendale CA 91201
Tel: 800-345-4448 • www.lightingcontrols.com

TECHNICAL GLOSSARY

ACTIVE DEVICE

Any device with an onboard transformer, that acts as a source of electrical energy for the bus. (e.g. Blue Box LT panel)

ADDRESS

The associated number that identifies a device on the bus. A Blue Box can have up to 127 unique addresses to which devices must be assigned in order for them to work properly. Each device must be assigned one address (or more for relay panels with more than 8 relays and defined in the Bus Map screen.

ADDRESS COLLISION

When more than one device on the bus is assigned the same address; refer to the "System Diagnostics Tools" section in the O&M for information on resolving this issue.

BUS

A system consisting of digital devices communicating over Cat. 5 cables.

BUS MAP

Defines the addresses assigned to the devices on the bus; for example, a relay panel must be defined as "Panel LCP x", a 1 button switch as 1-Btn Switch, etc.

BUS-POWERED DEVICE

Any device that relies on the 12V supplied by the bus (supplied by an active device transformer) for its power (e.g. digital switches, and photosensor cards)

BUS SCAN

Displays the 1 – 127 addresses available on the bus that can be assigned to LC&D digital device

The first row in first column displays addresses 1 – 10, while the first row in the second column displays addresses 11 – 20 and so on. A "0" indicates no device has been assigned to the address, or there is a missing device.

Any relay panel assigned to an address will display the number "3", for each 8 relays. A switch, PCC or DI card will display a "1", and a "Link-to-" card such as a "T-Link" or "Link-2-Ethernet" will display a "2". A relay panel takes

up one address for every 8 relays it contains. Therefore, a Blue Box LT 16 would take two addresses and the bus scan display would show "33" on the two consecutive addresses that are assigned to the panel.

CAT. 5

Category 5 (Cat. 5) is a cabling standard used for high speed data transmission. A Cat. 5 cable consists of 4 twisted pairs of wire to reduce external interference (e.g. from line voltage) and is crimped with a RJ 45 connector. There are two commonly used wiring standards when making up Cat 5. Cables: 568A and 568B. Either one may be used on a bus as long as it is uniform all along.

CONDUCTOR

Any wire. (e.g. the 8 twisted-pair wires inside a Cat. 5 cable are referred to as conductors).

CONTACT CLOSURE DEVICES

A device (e.g. low-voltage analog switch) that sends a command to a dry contact device (e.g. DI card) input.

DIGITAL TIME CLOCK (DTC)

Contains all programming features for the system (Blue Box LT Master Panels)

DRY CONTACT

A device that does not require voltage to function; for example, a low-voltage analog switch tied to a DI card input when the switch button is pressed, a closed circuit is formed between the input pin and ground and finally a signal is sent to perform a certain function.

"EZ" BRAND CONNECTOR

An EZ brand connector is an easy-to-use RJ45 connector used for crimping Cat. 5 cables. Every LC&D device is provided with (at least) 2 RJ45 connectors called "EZ connectors". Instructions on how to crimp Cat. 5 cables with EZ connectors are included in the "System Startup and Cabling Guide."

GROUND LUG

Provides a pathway to "Earth-Ground" connection for high-voltage cabling.

TECHNICAL GLOSSARY (Continued)

GROUP

Any given switch button, DI input or photocell input may be programmed to control up to 8 relays. If more than 8 relays need to be programmed, or if any relay(s) need to be controlled by a schedule, a Group must be used. There are different types of groups available for programming. Refer to the "Group Types" and "Groups FAQ" for details.

LAST INPUT OVERRIDE

When a command is sent to the DTC from a device which will override any previous commands that may have been sent to (e.g. if a switch button is used to turn a relay ON and a photocell is programmed to control the same relay and it detects a high light level, it will override the ON command sent by the switch and turn OFF the lights).

LCP

Acronym for "Lighting Control Panel" - may be a master or slave panel (e.g. Blue Box LT master or slave panel)

LOAD

Any device that requires power to operate (e.g. Lights); and since loads are tied in to relays, the terms "load" and "relay" are used interchangeably in this manual.

OCCUPANT SENSOR

Detects a person moving into a space to control relays. Certain OCC sensors have dual technology sensing for more reliable operation.

OSCILLOSCOPE

An electronic test device that allows signal voltages to be viewed, usually as a two-dimensional graph of one or more electrical potential differences (vertical axis), plotted as a function of time or of some other voltage (horizontal axis).

Refer to the "Oscilloscope testing procedure" on how to use an oscilloscope with the bus to detect bad cables, devices, misplaced or missing terminators.

PHOTOCELL

A device that measures the light intensity entering the lens; photocells can be wired to the Blue Box LT to control relays throughout any of the first 8 time schedules.

SMACKER STRIP

Used to send a signal to control relays (Blue Box LT 16 only)

STABLE BUS

When all Cat. 5 cables are functioning and have been crimped properly, both terminators are placed at the two ends of the bus, and all devices are present on the bus and communicating and functioning properly.

TERMINATOR

It is a jumper that completes a circuit by shorting a resistor, placing it in parallel with the rest of the circuit. When placed on the two end devices of a bus, terminators eliminate signal reflections along the bus. If installed in the middle of the bus, it blocks signals from going past the point where it is placed. Therefore, extra care must be taken to not place a terminator anywhere except at the two end devices on a bus.

TIME SCHEDULE

A programming option in the DTC that is used to turn relays ON and OFF at specified times. Relays that need to be controlled by a schedule must be placed in a group.

TRANSFORMER

Takes the high-voltage at the "primary side" terminals and "steps-down" the voltage. In the case of a Blue Box LT, the transformer accepts 120/277 V ac and outputs 20 V ac between the outer terminals and 10 V ac between the center and either of the two outer terminals.



LIGHTING CONTROL & DESIGN

905 Allen Ave • Glendale, CA 91201 • Support 800-345-4448 • www.lightingcontrols.com

LCD880&M03Sept08

CHELSEA DIGITAL SWITCH

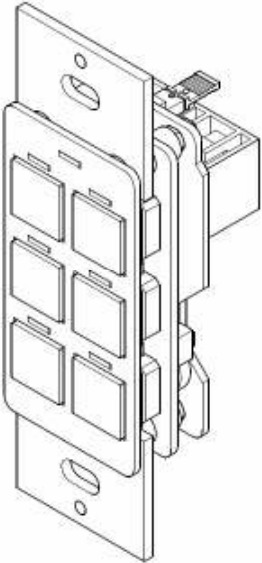

ADVANCED PROGRAMMING GUIDE

CONTENTS

1. Overview.....	Page 1
2. Important Programming Notes	Page 2
3. The Switch Setup Screen (First Screen)	Page 3
a. 7 On = _____	Page 4
b. 8 On = _____	Page 5
c. BTN Beep	Page 6
d. Button 1 Address	Page 6
e. 9-14 disable 1-6	Page 7
f. Debounce	Page 7
4. The Switch Setup Screen (Second Screen)	Page 9
a. ALL-OFF logic except groups	Page 9
b. LED logic for other buttons	Page 10
5. The Button Edit Screen	Page 11
a. LED mode	Page 11
b. Toggle mode	Page 12
c. Debounce	Page 12
6. Common Applications	Page 13
a. How do I disable a particular switch button?	Page 13
b. How do I set a button to give an audible “error” beep when someone presses a disabled button?	Page 14
c. How do I make a switch give an audible alert during a blink warning period?	Page 15
d. How do I set up a room with a partition, so that the switches change their function depending on whether the partition is open or closed?	Page 17

Overview

The Chelsea Digital Switch has been updated with several new programmable features. In summary, they are:

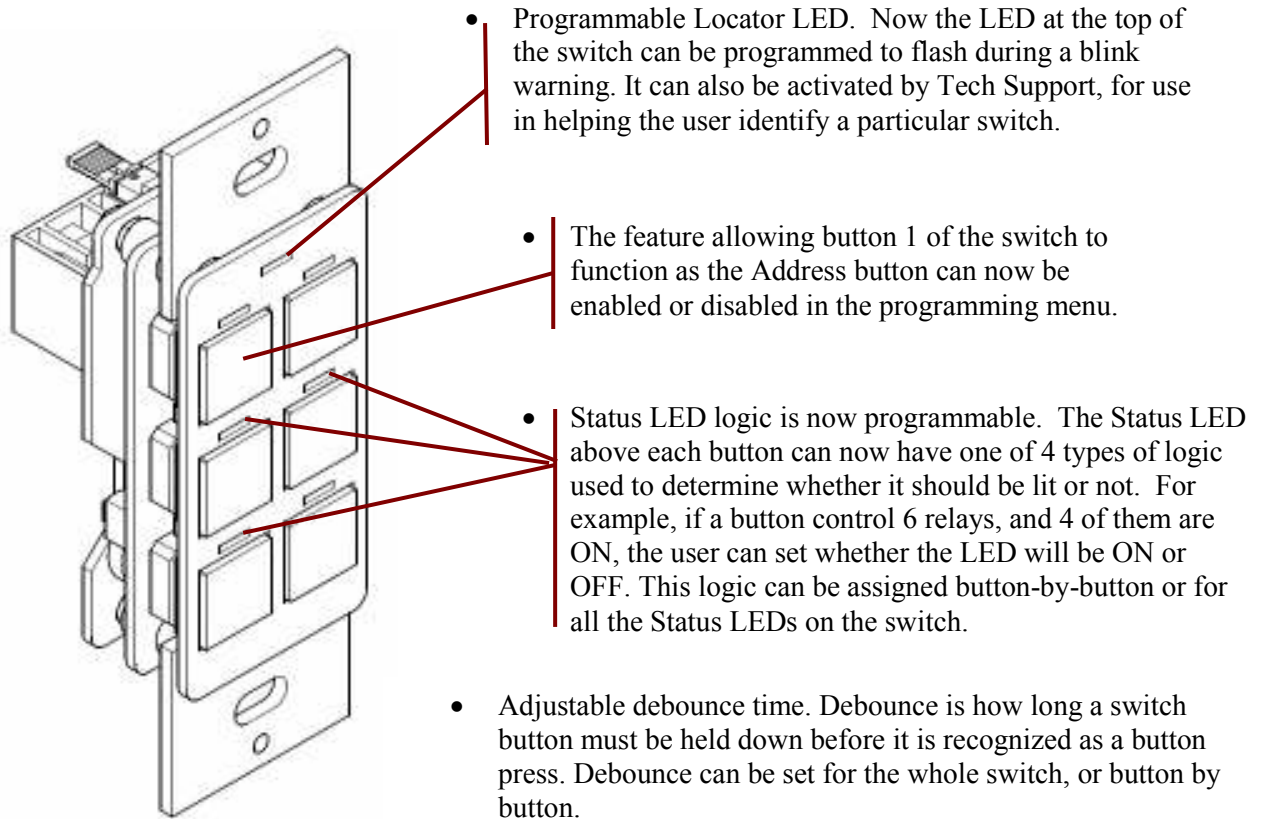

- Audible beep alert which can be used to notify users during a blink warning period before the lights shut off. The beep pattern is programmable and can also be used by Tech Support to help the customer locate a specific switch on the bus.
- Alternate button programming. Chelsea Digital Switches can now have two sets of programming for six buttons, or three sets of programming for three buttons. Each set of programming can be activated by a time schedule, override switch, etc. This feature is useful for setting buttons to function differently at different times of day, or in partitionable rooms where a switch functions differently depending on whether a partition is open or closed.
- Programmable Toggle logic. If a button controls multiple relays, it is important to synchronize them when toggling them all at once. If some of the relays are ON and some are OFF, it is now possible to specify whether the switch syncs them all ON or all OFF when toggling.
- Enabling and disabling individual switch buttons is still an available feature carried over from the previous version of the Chelsea. Enabling and disabling buttons can now be allowed or not allowed for a switch in the programming menu. Additionally, disabled buttons can be set to trigger a rapid series of beeps when pressed, so the user knows that the button has specifically been disabled by programming.

! Important Programming Notes !

To use the advanced features of the new Chelsea Digital Switch, please ensure the following:

- Always set a Chelsea Digital Switch as a “14 Button Switch” in the Panel/Switch Types screen. This is true even if the switch only has 1, 2 or 3 physical buttons. The reason for this is because advanced programming requires setting parameters for buttons 7-14, even though they are “virtual” buttons and not physically present on the switch.
- To access advanced programming functions of the Chelsea Switch, you must have DTC clock version 4.48 or later.
- To use advanced programming functions of the Chelsea Switch, you must be using switch firmware 1.12 or later. The version of firmware a switch has is displayed in the lower left corner of the SETUP screen for that switch.

The Switch Setup Screen (First Screen)

To access the screen, navigate to the switch you want to program, highlight the word **SETUP** and press **ENTER**.

USER MENU → PROGRAM SWITCH → SWITCH# → SETUP

Select "SETUP"
and press
ENTER

```
SELECT BTN SWI ID#7
SETUP          PAGE 1-3
B1:    BUTTON 1
B2:    BUTTON 2
B3:    BUTTON 3
B4:    BUTTON 4
B5:    BUTTON 5
B6:    BUTTON 6
```

The Switch Setup Screen has a number of parameters which can be set as shown below.

7 ON = _____
8 ON = _____
Btn Beep
Button 1 Address
9-14 Disables 1-6
Debounce

```
SWITCH ID#7 SETUP
7 ON= Beep
8 ON= Normal
Btn Beep: Off
Button 1 Address: Y
9-14 Disables 1-6: N
Debounce: By Button
Ver 1.12
```

More

Table 1.1

7 ON = _____	
<p>This field determines what happens when the LED status light associated with Button 7 is turned ON.</p> <p style="text-align: center;">Generally if the button is set to ON MODE and the relay it controls is ON, the LED will turn ON as well. This also applies to the opposite mode: if the button is set to OFF MODE and the relay it controls is OFF, the LED will also generally turn ON (the only exceptions are if the logic of the Status LEDs are changed as described later in this guide).</p> <p>Note that there is no physical Button 7 or physical Status LED for Button 7 on a Chelsea Digital Switch. So Buttons 7-14 are virtual buttons used for programming purposes only, and the associated Status LEDs are also just virtual placeholders that are turned on and off. Usually, virtual Buttons 7 and 8 will be set to operate a spare relay or an empty relay position rather than a relay with a connected load.</p>	
Possible Values	Result
Normal (default value)	None. Setting this value to “Normal” in a Chelsea Digital Switch means that nothing will happen when the virtual LED associated with Button 7 is turned ON.
BTS 1-6 < 9 - 14	When the virtual LED associated with Button 7 is ON, the programming for buttons 1-6 will be replaced with the programming for buttons 9-14. When the LED is OFF, buttons 1-6 will revert to their original programming.
BTS 1-3 < 9 - 11	When the virtual LED associated with Button 7 is ON, the programming for buttons 1-3 will be replaced with the programming for buttons 9-11. When the relay is OFF, buttons 1-3 will revert to their original programming.
BEEP	When the virtual LED associated with Button 7 is ON, the switch will make a beeping sound. Highlighting the word BEEP and pressing ENTER will allow you to set the beep pattern.
Locator	When the virtual LED associated with Button 7 is ON, the switch’s Locator LED will flash. Highlighting the word Locator and pressing ENTER will allow you to set the flash pattern.
Disable 1-6	When the virtual LED associated with Button 7 is ON, buttons 1-6 will be disabled.
Disable 1-14	For a Chelsea Switch, this has the same effect as “Disable 1-6”. However, when programming a Digilink, it allows all Digilink inputs (1-14) to be disabled.
Beep + Locator	When the virtual LED associated with Button 7 is ON, the switch will make a beeping sound and the Locator LED will flash. Highlighting the words Beep + Locator and pressing ENTER will allow you to set the beep and flash pattern.

Table 1.2

8 ON = _____	
<p>This field determines what happens when the LED status light associated with Button 8 is turned ON.</p> <p>The operation of this field is almost identical in operation to the “7 ON = ___”. The parameters are the same as those given in Table 1.1 above with a few exceptions noted below.</p> <p>In general, the BTS 1-6 < 9 – 14, BEEP, Locator, and Disable 1-6 functions assigned to “7 ON = ___” take priority over their “8 ON = ___” counterparts.</p> <p>For example: If a switch is set to “7 ON = BEEP” and “8 ON = BEEP” and both virtual LEDs are ON, the switch will have the BEEP pattern of “7 ON = BEEP” not the pattern of “8ON = BEEP”.</p> <p>If a switch is set to “7 ON = LOCATOR” and “8 ON = BEEP” and both virtual LEDs are ON, the switch will blink the Locator LED and also beep.</p>	
Possible Values	Result
Normal (default value)	None. Setting this value to “Normal” in a Chelsea Digital Switch means that nothing will happen when the virtual LED associated with Button 8 is turned ON.
BTS 1-6 < 9 – 14 BEEP Locator Disable 1-6	These settings operate in the same way as they are described in table 1.1
BTS 1-3 < 12-14	When the virtual LED associated with Button 8 is ON, the programming for buttons 1-3 will be replaced with the programming for buttons 12-14. When the relay is OFF, buttons 1-3 will revert to their original programming.
Disable 9-14	Used only in Digilinks to disable higher numbered inputs.

** “8 ON = ___” Does not have a “Beep + Locator” option.

Important Note On Using “7 ON = 1-3 ← 9-11” and “8 ON = 1-3 ← 12-14” in tandem:

If the switch has the settings “ 7 ON = 1-3 ← 9-11” and “ 8 ON= 1-3 ← 12-14”, and the relays operated by Button 7 and Button 8 are BOTH ON, then buttons 1-3 will execute both sets of programming (9-11 and 12-14) at the same time. Please ensure that there is no conflicting programming as the behavior of the loads controlled will become unpredictable. An example of conflicting programming is Button 9 turning ON a relay and Button 12 turning OFF a relay.

Table 1.3

BTN Beep	
This field determines when the switch's buttons will cause a beeping sound.	
Possible Values	Result
OFF	There will never be a beeping sound when a button is pressed. Note that any beep alerts set to take place using the "7 On = _____" or "8 On = _____" fields will still be executed. Setting "BTN Beep" to OFF only effects normal button presses, not special alerts.
PUSH only	The buttons on the switch will beep when pressed. (Note that operating the same load(s) from another location will not cause the beep) There will be no rapid series of beeps when a disabled button is pressed, it will simply cause the standard single beep.
Disable	Buttons will not normally beep when pressed; however, if the user presses a disabled button, the switch will give a rapid series of beeps to alert them that the button will not operate as expected because it has been disabled.
Push + Disa.	Buttons on the switch will give a standard single beep when pressed. If the user presses a button that has been disabled, the switch will alert them with a rapid series of beeps.

Table 1.4

Button 1 Address	
This field determines whether Button 1 on the switch will act as the Address Button (meaning that the user can set and read the address by pushing Button 1 instead of having to press the Address Button on the back of the switch). This is generally set to "Y" (Yes) except on Digilinks, which are always set to "N".	
Possible Values	Result
Y	Yes, Button 1 will function as the Address Button
N	No, Button 1 will not function as the Address Button

Table 1.5

9-14 disable 1-6	
<p>Determines whether “virtual” buttons 9-14 can be used to disable buttons 1-6 on the physical switch. For example, if virtual Button 9 is set to turn on relay X, then any time relay X is ON, the physical Button 1 will be disabled. If relay X is OFF, then Button 1 will function normally.</p> <p>The same correspondence exists between virtual Button 10 and physical Button 2, virtual Button 11 and physical Button 3, etc.</p>	
Possible Values	Result
Y	<p>Yes, virtual Buttons 9-14 will enable and disable physical Buttons 1-6. This is the normal, default setting. However, there are times when you should not use this functionality as described below.</p>
N	<p>No, virtual Buttons 9-14 will NOT enable and disable physical Buttons 1-6. You should use this option in the following circumstances:</p> <ul style="list-style-type: none"> • If you have set up alternate button programming sets (e.g. you have set “7 ON = BTS 1-6 < 9 – 14” as described earlier in this section). • If you are already using other button disable settings, such as “7 On = Disable 1-14” described earlier in this section. • If you are programming a Digilink, which uses any of the inputs between 9 and 14.

Table 1.6

Debounce	
<p>This field sets how long the user must hold down a switch button before the system recognizes the button press. If the button is released before the full duration of the debounce time, the press is ignored and no programming is executed.</p>	
Possible Values	Result
By Button	<p>This value means that the Debounce will be set individually for each individual Button in the Button’s “Edit” menu. There will be no overall setting for all the buttons on the switch.</p>

Selectable value between 0.05 sec and 5.00 sec.	These are global values that apply to all of the switch's buttons. Whatever value is selected will be how long the user must hold down the button before its programming is activated. For example, setting the value to 2.00 sec means that when the user first presses a button on the switch, nothing will happen. However, if the user continues holding down the button for at least 2 full seconds, the button will then operate the relays it was set to control. The default setting is 0.05 sec. Debounce affects button beeping the same way it affects programming.
---	--

Important Note on Debounce:

Use debounce carefully since a long debounce time can make it seem like a switch is not working. If a switch does not appear to function, always check for a debounce setting before assuming that the switch is bad.

MORE

To go to the second page of switch setup options, highlight the field "MORE" and press ENTER.

The Switch Setup Screen (Second Screen)

The Switch Setup Screen has additional parameters shown on a second page in the DTC screen. Along with the Debounce option on the first screen, these parameters are global in that they override any local LED logic set in the EDIT menu and apply to all buttons on a switch. These parameters can be set as shown below:

LED Logic for buttons in ALL-OFF mode, except buttons controlling MOMENTARY OFF groups.

LED logic for buttons in all other modes.

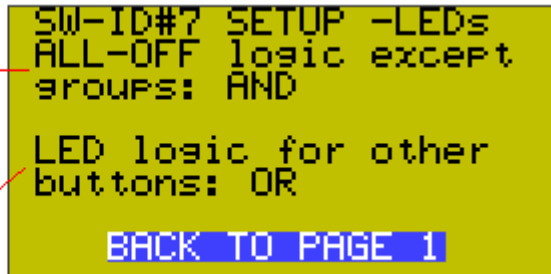

Table 2.1

ALL-OFF logic except groups	
Sets the logic which determines if the Status LED over each of the switch's buttons should be on or off. This field applies only to buttons programmed in OFF MODE. If a button only turns lights OFF, then it is customary to have the Status LED be lit when all of the controlled relays are in the OFF position. However, there are some applications when different logic is needed.	
Possible Values	Result
AND	The Status LED on a button set to OFF MODE will light up only if ALL the controlled relays are OFF. (This is also called "True" switch logic and is usually used for buttons in OFF MODE or MIX MODE).
OR	The Status LED on a button set to OFF MODE will light up if one OR more of the controlled relays are OFF.
OR-INVERT	The Status LED on a button set to OFF MODE will light up only if NONE the controlled relays are OFF (i.e. they are all ON)
AND-INVERT	The Status LED on a button set to OFF MODE will light up if ONE OR MORE of the controlled relays are ON. Therefore, if they are all OFF, the LED light will not be lit, but if at least one relay is ON, the LED will be lit.

Table 2.2

LED logic for other buttons	
Sets the logic which determines if the Status LED over each of the switch's buttons should be on or off. This field applies to buttons in TOGGLE MODE, ON MODE, MAINTAIN, MIX MODE (all other settings except OFF MODE).	
Possible Values	Result
AND	The Status LED on a button will light up only if ALL the controlled relays are ON. In MIX MODE the LED will be lit only if ALL the controlled relays are in the state (ON or OFF) the button was programmed to set them to. (This is also called "True" switch logic. It is usually used for MIX MODE or OFF MODE buttons.)
OR	The Status LED on a button will light up if ONE OR MORE of the controlled relays are ON. In MIX MODE the LED will be lit if ONE OR MORE of the controlled relays are in the state (ON or OFF) the button was programmed to set them to. (Usually this logic is used for buttons that are set to something other than MIX MODE or OFF MODE).
OR-INVERT	The Status LED on a button will light up only if NONE of the controlled relays are ON (i.e., they are all OFF). In MIX MODE the LED will be lit only if NONE of the controlled relays are in the state (ON or OFF) the button was programmed to set them to (they must all be in the opposite state from what the button was assigned to set them to).
AND-INVERT	The Status LED on a button will light up only if ONE OR MORE of the controlled relays are OFF. In MIX MODE the LED will be lit only if ONE OR MORE of the controlled relays are in the opposite state from what the button was programmed to set them to.

BACK TO PAGE 1
To go back to the first page of switch setup options, highlight the field "BACK TO PAGE 1" and press ENTER.

The Button Edit Screen

To access the Button EDIT screen, navigate to the switch button you want to program, highlight the word EDIT and press ENTER. These parameters are local, meaning that they apply to each individual button only, not the entire switch.

USER MENU → PROGRAM SWITCH → SWITCH# → BUTTON# → EDIT

Select "EDIT"
and press
ENTER

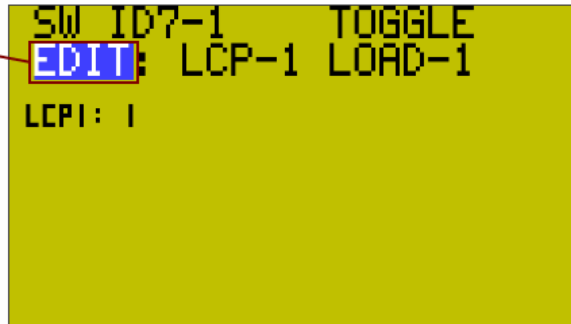

The Button Edit Screen has the parameters which can be set as shown below.

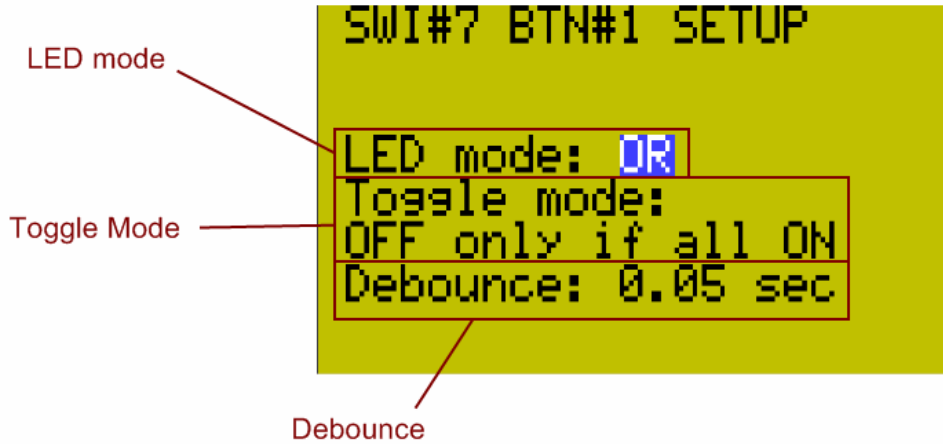

Table 3.1

LED mode
<p>Sets the logic which determines if the Status LED over the button should be on or off.</p> <p>The operation of this field is identical in operation to the SETUP second screen LED logic except these settings apply only to a single button because they are local settings. The parameters are the same as those given in Table 2.1, if OFF MODE is used, or Table 2.2 above for all other modes.</p>

Table 3.2

Toggle mode	
<p>Sets how the button synchronizes multiple relays when toggling. For example, if a switch button is toggling relay X, relay Y and relay Z, the user can decide what happens when relay Y is ON and relays X and Z are OFF. The least desirable behavior is to have the relays just flip states so that no matter how the TOGGLE button is pressed either, relay Y is OFF and relays X and Z are ON, or relay Y is ON and relays X and Z are OFF. This would make it impossible to get all the lights ON or OFF at the same time. Therefore, one of the two types of logic below is used to sync the relays that are being toggled by a switch button.</p>	
Possible Values	Result
OFF if any load ON	If any ONE OR MORE of the relays controlled by the switch button are ON, then pressing the toggle button will turn ALL relays OFF.
OFF only if all ON	If the relays are out of sync, the toggle button will first bring them all ON. Then, once they are all ON, pressing the toggle button again will turn them all OFF.

Table 3.3

Debounce
<p>Works in the same manner as SETUP menu Debounce except it applies to individual buttons, has no “By Button” option, and only appears on screen if SETUP menu Debounce is set as “By Button”.</p>

Important Note on Debounce:
Use debounce carefully since a long debounce time can make it seem like a switch is not working. If a switch does not appear to function, always check for a debounce setting before assuming that the switch is bad.

Common Applications

Question:

How do I disable a particular switch button (for example, button 3)?

Answer:

1. Go to the Program Switch screen and select the switch you want to disable the button for. For physical Button 3, you would use the virtual Button 11 to enable and disable it. (See table 4.1 below)

Button Enable / Disable Relationships	
This virtual button:	Disables this physical button:
9	1
10	2
11	3
12	4
13	5
14	6

2. Select Button 11 on the Program Switch Screen. Assign a spare relay or empty relay position to this button and make sure it is set to ON MODE.
3. Back on the Program Switch screen, again select the switch you want to program and then go to the “SETUP” field and press ENTER.
4. Ensure that the option “**9-14 disable 1-6**” is set to “**Y**” (for Yes). See table 1.5 earlier in this guide for details.
5. Now, when you turn the relay you selected in step 2 above ON, Button 3 will be disabled and not function. When you turn the relay OFF, Button 3 will function again. Remember, you can turn this relay ON and OFF using schedules, groups, other switches, or even photocells that pass a certain light level!

Question:

How do I set a button to give an audible “error” beep when someone presses a disabled button?

Answer:

It can be very frustrating or confusing to a user when they press a button that usually turns certain lights on and off, only to find that nothing is happening. Sometimes, this happens when a switch button has been programmed to be disabled, but the user has no way of knowing. Therefore, it is helpful to set up the switch to make an “error” beep if the user presses a disabled button. To do this, follow the steps below:

1. Go to the Program Switch screen and select the switch you want to set up the error beep for.
2. Highlight the “SETUP” field and press ENTER
3. Set the option labeled “**BTN Beep**” to “**Disable**”. This causes the switch to emit a rapid series of beeps if a user presses a button that has been disabled. See Table 1.3 earlier in this guide for details.
4. If you want the switch to make a standard beep whenever an enabled button is pressed, and a rapid series of beeps when a disabled button is pressed, set the “**BTN Beep**” option to “**Push + Disa.**” See Table 1.3 earlier in this guide for more details.

Question:

How do I make a switch give an audible alert during a blink warning period?

Answer:

It is a fairly common request to have users notified a few minutes before the lights turn off, so they have an opportunity to override the off-sweep. Instead of having the lights flash, or a separate horn installed, the new switch can be set to generate a beeping alert pattern as a warning that the lights will be shutting off shortly. To do this:

1. First, create a Maintain+Blink Group containing the relays that are going to be turned on and off with the schedule. You can use any Timer and Blink Warning settings you wish; typical values are a 2 hour Timer and a 5 minute Blink Warning. Make sure that you include one spare relay or empty relay position in the group. This will be the "Horn Driver relay"
2. Once you have created the Maintain + Blink Group above, go to the Relay Properties Screen for the individual relay you set as the "Horn Driver relay". Change the Horn Driver Mode parameter to "Y" (for Yes). Set the Horn One parameter to the length of time you want the audible alert to last. Then exit out of the screen.
3. (Optional) You will probably want to set the "No Blink" option to "Y" (for Yes) for all the relays in the Group to prevent them from flashing OFF and then ON again when the Blink Warning starts. Sometimes, the flash is desirable, but since there is going to be an audible alert, the lights blinking will most likely not be necessary.
4. Now create a new MOMENTARY ON Group that contains all the same relays as your group from step 1 above, including the Horn Driver Relay.
5. Assign the MOMENTARY ON Group to the switch and button that you want to behave as an override, to turn the lights on or keep them on at the end of the schedule / blink warning period.
6. For the same switch, go to the PROGRAM SWITCH screen, select the switch, highlight the "SETUP" field and press ENTER.
7. On the switch SETUP screen, set either the "7 ON =" or "8 ON =" field to the option "BEEP". (See Tables 1.1 and 1.2 earlier in this guide for full details).
8. In the Program Switch Screen, set either Button 7 or Button 8 (depending on which you selected in the previous step) to ON MODE, and have it associated with the relay you set earlier as the Horn Driver Relay.

9. That's it. Now, at the end of the schedule, the switch will start beeping to signal that the lights will be shutting off shortly. If the user presses the override button on the switch, the beep alert will stop, and the lights will stay on for an additional 2 hours (or whatever duration the Timer was set to in the Maintain+Blink Group). At the end of this 2 hour period, the switch will start beeping again to signify the lights will be shutting off, at which point the user can override the shutoff again and start the cycle over again, or simply let the lights go off.

** The procedure just described can also be used to make the Locator LED blink. Just replace "BEEP" in step 7 with "Locator".

Question:

How do I set up a room with a partition, so that the switches change their function depending on whether the partition is open or closed?

Answer:

Let's take a scenario where a room has a switch on the north wall, a switch on the south wall, and a partition that can separate the room into a north half and a south half.

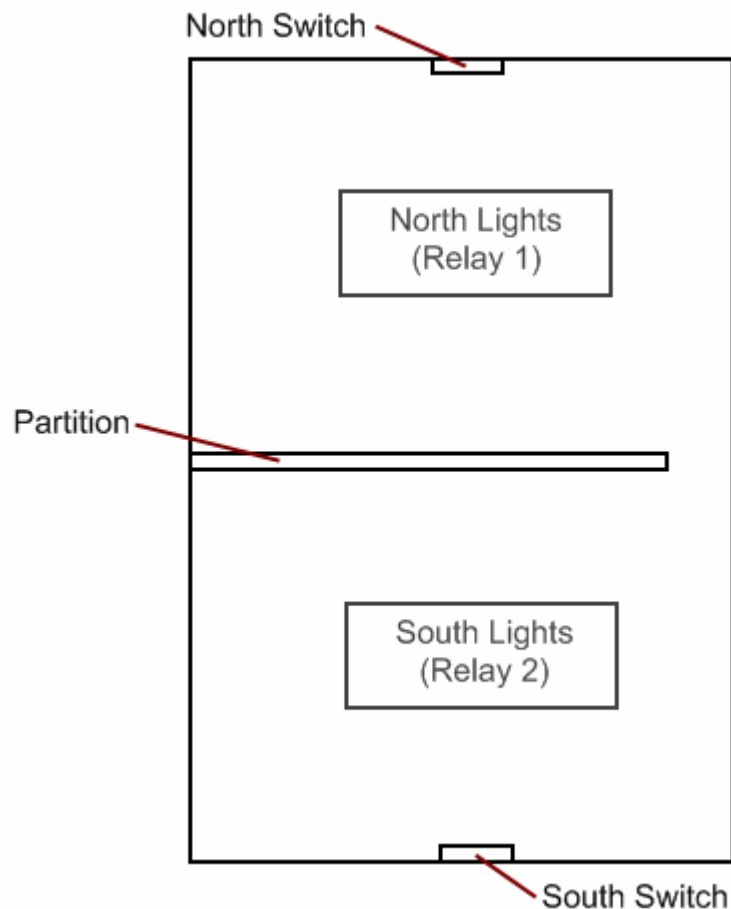

Each switch has an ON button and an OFF button. When the partition is open, the switches control both sets of lights in the room (North *and* South lights, i.e. Relay 1 *and* Relay 2). When the partition is closed, the South Switch turns on and off the South Lights (Relay 2) *only*, and the North Switch turns on and off the North Lights (Relay 1) *only*.

Here are the steps to accomplish this:

1. For the North Switch, program Button 1 to ON MODE for Relay 1 and Relay 2. Program Button 2 to OFF MODE for Relay 1 and Relay 2.
2. While still in the Program Switch screen for the North Switch, set Button 9 to ON MODE for Relay 1 *only*. Program Button 10 to OFF MODE for Relay 1 *only*.
3. Program Button 7 to ON MODE for a spare relay or empty relay position (Relay X).
4. Now go to the North Switch “SETUP” screen and set the parameter “7 ON =” to the option “BTS 1-6 < 9 – 14”. (See Table 1.1 for full details).
5. Now, for the South Switch, program Button 1 to ON MODE for Relay 1 and Relay 2. Program Button 2 to OFF MODE for Relay 1 and Relay 2.
6. While still in the Program Switch screen for the South Switch, set Button 9 to ON MODE for Relay 2 *only*. Program Button 10 to OFF MODE for Relay 2 *only*.
7. Program Button 7 to ON MODE for the same spare or empty relay position you used in step 3 above (Relay X).
8. Now go to the South Switch “SETUP” screen and set the parameter “7 ON =” to the option “BTS 1-6 < 9 – 14”. (See Table 1.1 for full details).
9. Set another switch button, or a Digilink with an input coming from a partition sensor, to turn ON Relay X when the partition is CLOSED and turn OFF Relay X when the partition is OPEN.
10. That’s it. When the partition is closed or separate switch button is pressed, each switch will only control the lights in their half of the room. When the partition is open, each switch controls ALL of the lights in the room.

ADDITIONAL BLUE BOX RESOURCES

(hyperlinks provided below)

Software Guides

[Unity GX2™ Customer Submission Guide](#)

[Unity 2.2 Software](#)

[Unity VClock Software](#)

[BACnet Configurator](#)